

S
U
R
G
I
T
E
C



SURGICAL INSTRUMENTS



Company Profile

SurgiTech international is a family owned organization working for more than 40 years founded in Sialkot, Pakistan.

It enables us a lifetime of knowledge about the world of surgical instruments. This knowledge allows us to better understand the needs of our customers in a way most other instrument companies are unable to do. SurgiTech international is manufacturers and exporters of High Quality Surgical/Medical instruments for all specialties: i.e. General Surgical Instruments, ENT Instruments, Plastic Surgery Instruments, Dermal Instruments, Liposuction Cannulas and Accessories, Electrosurgical Instruments, Gynecology Instruments, Neurosurgical and Microsurgical Instruments, Spinal Instruments, Orthopedic Instruments, Orthopedic Implants, Dental Instruments, Cardiovascular/Thoracic Instruments, Urological Instruments, Arthroscopic Instruments, Veterinary Instruments, Colon and Rectal, Ophthalmic Instruments.

SurgiTech international committed to deliver excellent services and quality products at affordable prices to our value able buyers.

We assure you that working with us will be a most profitable and satisfactory experience for you because we consider our customers as our partners and we work for their complete satisfaction. Since we are a family owned manufacturing company, we provide knowledgeable, professional and prompt 24/7 live customer service.

Most of our items are available in stock and on order confirmation it is dispatched on the same day, detailed pictures of the order and DHL/FEDEX Tracking number is also provided. If something is not available in stock.

It needs 5-10 days to manufacture.

All our Instruments are manufactured from Japanese, German and Pakistani Stainless steel.

We have professional approach in throughout product manufacturing process, from material to heat treatment, from pickling to electro-polishing, from fixing to ultrasonic cleaning. Worldwide reputation is on our credit for excellent services and best quality products. All products are hand finished to perfection, many years of experience and knowledge is behind our success.

We are Original Equipment Manufacturer (OEM) and also offer Own Brand Labeling (OBL) for your instruments.

INDEX

01	Diagnostic Instruments	01-05
02	Anesthesia Instruments	07-17
03	Scalpels Knives	19-35
04	Scissors	37-106
05	Ophthalmic Instruments	108-153
06	Forceps Instruments	155-161
07	Hemostatic Forceps	163-181
08	Atraumatic Forceps	183-228
09	Towel Clamps	230-233
10	Polyps and Dressing Forceps	235-247
11	Retractors	249-272
12	Probes, Spatulas, Applicators	274-275
13	Trocars, Puncture Needles	277-278
14	Needle Holders	280-285
15	Suture	287-293
16	Sterilizing Aids	295-298
17	Plaster of Paris	300-302
18	Bone Surgery, Osteosynthesis	304-340

19	Neurosurgery Laminectomy	342-356
20	Otology	358-371
21	Rhinology	373-390
22	Mouth and Tongue	392-396
23	Tonsils	398-401
24	Larynx	403-405
25	Tracheostomy, Goitre	407-409
26	Thorax	411-442
27	Gall Bladder, Kidney	444-455
28	Intestines and Stomach	457-464
29	Urology	466-483
30	Rectum	445-488
31	Gynecology	490-539
32	Obstetrics	541-548
33	Dermatology Hygiene	550-551
34	Different Containers	553-563
35	Aluminium Containers	565-573
36	High Frequency Surgery	575-580



Diagnostic Instruments

SURGITECH



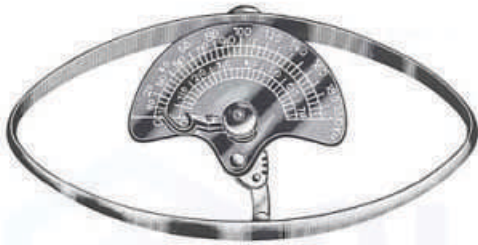

COLLIN
 STI-01-006 Erwachsene · Adult
 STI-01-007 Kinder · Child · enfant
 niños · bambini



STI-01-008



VARIFOCAL
 STI-01-009



MAY
 STI-01-010



STI-01-011
Combination



STI-01-012
Econom Universal



STI-01-013
Otoskop · Otoloscope · Otopscopio



BOWLES
STI-01-014

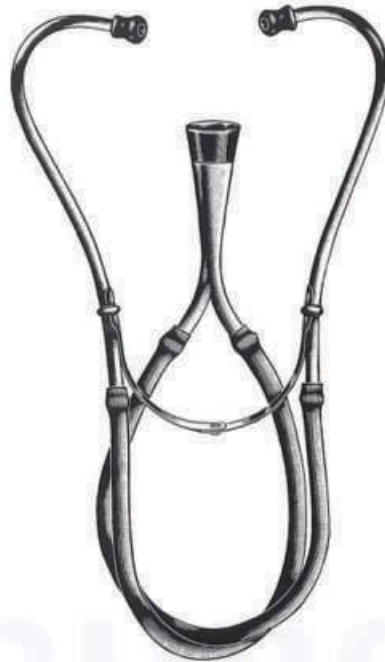

FORD
STI-01-015



DUPLEX
STI-01-016



PINARD
STI-01-017
15 cm



PINARD
STI-01-018
18 cm



cm TAYLOR
 17 STI-01-019
 20 STI-01-020



TRAUBE
 STI-01-021



BABINSKY
 STI-01-022
 22 cm



TROEMNER
 STI-01-023
 24 cm



DEJERINE
 STI-01-024



DEJERINE
 STI-01-025



BERLINER
 STI-01-026

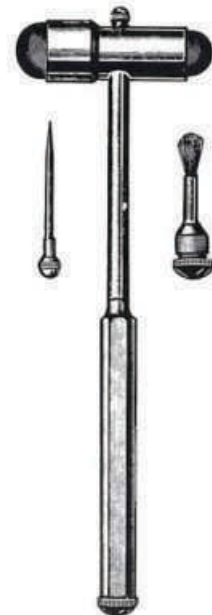

BUCK
 STI-01-027



Anesthesia Instruments

E
N
V
I
S
A
M



POOLE
STI-02-028
ø 10 mm (30 Charr.)



POOLE
STI-02-029 ø 6 mm (18 Charr.)
STI-02-030 ø 8 mm (23 Charr.)

STI-01-018
Saugspitze
Suction Tip
Pointe de succion
Cabezal para aspiración
Punta per aspirazione



komplett mit Saugspitze und Schlaucholive

complete with suction tip and connector

complet avec pointe de succion et raccord

completo con punta de succión y conector

completi con punte d'aspirazione e raccordo

Schlaucholive
Olive
Olive
Oliva
Oliva

YANKAUER
STI-02-031



ANDREW-PYNCHON
STI-02-032
 ø 6 mm (18 Charr.)
 23 cm



WALTON YANKAUER
STI-02-033
 ø 10 mm (30 Charr.)
 32 cm

mit Absperrventil und
 abschraubbarem Rohr

with stopcock and tube
 to be screwed off

avec robinet et canule
 extérieure démontable

con interruptor y tubo
 desenroscable

con interruttore e tubo
 svitabile

Saugspitze ø 5 mm
Suction Tip ø 5 mm
Pointe de succion ø 5 mm
Cabezal para aspiración ø 5 mm
Punta per aspirazione ø 5 mm



Schlaucholive ø 9 mm
Olive ø 9 mm
Olive ø 9 mm
Oliva ø 9 mm
Oliva ø 9 mm

cm	DE BAKEY
16	STI-02-034
26	STI-02-035



DE BAKEY
STI-02-036
28 cm



Mandrin
Stylet
Doigt
Esfilete
Stiletto

cm	MAGILL	
24,5	STI-02-037	Fig. 1, ø 3,0 mm
24,5	STI-02-038	Fig. 2, ø 3,5 mm
24,5	STI-02-039	Fig. 3, ø 4,0 mm

Saug- und Spülkanüle
 Suction and Irrigation Cannula
 Canules d'aspiration et d'irrigation
 Cánulas para aspiración e irrigación
 Cannule per aspirazione e irrigazione



FINSTERER
STI-02-040
 32 cm

runde Öffnung
 round opening
 ouverture ronde
 abertura redonda
 apertura retonda



ø 6 mm

NUBOER
STI-02-041
 21 cm

ovale Öffnung
 oval opening
 ouverture ovale
 abertura ovalada
 apertura ovale



ø 6 mm

NUBOER
STI-02-042
 21 cm



STI-02-046
für Kleinkinder
for babies
pour nourrissons
para neonatales
per neonati



STI-02-047
für Kinder
for children
pour enfants
para niños
per bambini



STI-02-048
für Erwachsene
for adults
pour adultes
para adultos
per adulti

cm	MAGILL
17	STI-02-043
20	STI-02-044
25	STI-02-045

Spatel
Blades
Spatules
Espátulas
Spatole
MACINTOSH

Größe	Arbeitslänge mm	Kat. Nr.
Size	Working Length mm	Order Code
Taille	Longueur de travail mm	Cat. No.
Tamaño	Largo de trabajo mm	No. Cat.
Misura	Lunghezza di lavoro mm	Cat. No.

0	55	STI-02-049.00M
1	70	STI-02-050.01M
2	78	STI-02-051.02M
2A	90	STI-02-052.02M
3	108	STI-02-053.03M
4	133	STI-02-054.04M
5	150	STI-02-055.05M

0	55	STI-02-056.00S
1	70	STI-02-057.01S
2	78	STI-02-058.02S
2A	90	STI-02-059.02S
3	108	STI-02-060.03S
4	133	STI-02-061.04S
5	150	STI-02-062.05S



Alle Spatel sind in S = Seidenmatt oder M = glänzend erhältlich.
 All blades are available in S = Satin or M = Mirror finish.
 Toutes les spatules sont disponibles en S = mat ou en M = brillant.
 Todas las espátulas disponibles en versión S = satinada o M = pulida.
 Tutte le spatole sono disponibili nella versione S = opaca o M = lucida.

Spatel
Blades
Spatules
Espátulas
Spatole SD-01-001
MILLER

Größe	Arbeitslänge mm	Kat. Nr.
Size	Working Length mm	Order Code
Taille	Longueur de travail mm	Cat. No.
Tamaño	Largo de trabajo mm	No. Cat.
Misura	Lunghezza di lavoro mm	Cat. No.

0	55	STI-02-063.00M
1	80	STI-02-064.01M
2	130	STI-02-065.02M
3	170	STI-02-066.03M
4	180	STI-02-067.04M

0	55	STI-02-068.00S
1	80	STI-02-069.01S
2	130	STI-02-070.02S
3	170	STI-02-071.03S
4	180	STI-02-072.04S





Alle Griffe sind in S = Seidenmatt oder
 M = glänzend erhältlich.
 All handles are available in S = Satin or
 M = Mirror finish.
 Toutes les poignées sont disponibles en S = mat ou en
 M = brillant.
 Todos los mangos disponibles en versión S = satinada o
 M = pulida.
 Tutti i manici sono disponibili nella versione S = opaca o
 M = lucida.

Griffe Handles Poignées Mangos Manici	MACINTOSH MILLER	
Größe Size Taille Tamaño Misura	Kat. Nr. Order Code Cat. No. No. Cat. Cat. No.	Ersatzlampe Spare Lamp Ampoule de rechange Bombilla de repuesto Lampada di ricambio
Griff mittel, (Lieferung ohne Batterien)	STI-02-073.50M	04.350.60
Griff klein, (Lieferung ohne Batterien)	STI-02-074.51M	04.350.60
Griff mittel, (Lieferung ohne Batterien)	STI-02-075.50S	04.350.60
Griff klein, (Lieferung ohne Batterien)	STI-02-076.51S	04.350.60
Medium Handle, (supplied without batteries)	STI-02-077.50M	04.350.60
Small Handle, (supplied without batteries)	STI-02-078.51M	04.350.60
Medium Handle, (supplied without batteries)	STI-02-079.50S	04.350.60
Small Handle, (supplied without batteries)	STI-02-080.51S	04.350.60
Manche moyen, (livrée sans piles)	STI-02-081.50M	04.350.60
Manche petit, (livrée sans piles)	STI-02-082.51M	04.350.60
Manche moyen, (livrée sans piles)	STI-02-083.50S	04.350.60
Manche petit, (livrée sans piles)	STI-02-084.51S	04.350.60
Mango mediano, (suministro sin baterías)	STI-02-085.50M	04.350.60
Mango pequeño, (suministro sin baterías)	STI-02-086.51M	04.350.60
Mango mediano, (suministro sin baterías)	STI-02-087.50S	04.350.60
Mango pequeño, (suministro sin baterías)	STI-02-088.51S	04.350.60
Manico medio, (consegna senza batterie)	STI-02-089.50M	04.350.60
Manico piccolo, (consegna senza batterie)	STI-02-090.51M	04.350.60
Manico medio, (consegna senza batterie)	STI-02-091.50S	04.350.60
Manico piccolo, (consegna senza batterie)	STI-02-092.51S	04.350.60



Sets
 Sets
 Sets
 Conjuntos
 Sets

Größe
 Size
 Taille
 Tamaño
 Misura

MACINTOSH MILLER

Kat. Nr.
 Order Code
 Cat. No.
 Cat. No.
 Cat. No.

	78 mm	90 mm
Griff mittel mit MACINTOSH-Spatel Größe 1, 2 (78 mm) oder 2A mm (90 mm) und 3	STI-02-093.71M	04.310.71M
Griff mittel mit MACINTOSH-Spatel Größe 2 (78 mm) oder 2A mm (90 mm), 3 und 4	STI-02-094.72M	04.310.72M
Griff mittel mit MACINTOSH-Spatel Größe 1, 2 (78 mm) oder 2A mm (90 mm), 3 und 4	STI-02-095.73M	04.310.73M
Griff klein mit MILLER-Spatel Größe 0 und 1	STI-02-096.74M	----
Griff mittel mit MILLER-Spatel Größe 2, 3 und 4	STI-02-097.75M	----
Griff mittel mit MILLER-Spatel Größe 1, 2, 3 und 4	STI-02-098.76M	----
Medium Handle with MACINTOSH Blade size 1, 2 (78 mm) or 2A mm (90 mm) & 3	STI-02-099.71M	04.310.71M
Medium Handle with MACINTOSH Blade size 2 (78 mm) or 2A mm (90 mm), 3 & 4	EV-02-100.72M	04.310.72M
Medium Handle with MACINTOSH Blade size 1, 2 (78 mm) or 2A mm (90 mm), 3 & 4	STI-02-101.73M	04.310.73M
Small Handle with MILLER Blade size 0 & 1	STI-02-102.74M	----
Medium Handle with MILLER Blade size 2, 3 & 4	STI-02-103.75M	----
Medium Handle with MILLER Blade size 1, 2, 3 & 4	STI-02-104.76M	----
Manche moyen avec spatule MACINTOSH Taille 1, 2 (78 mm) ou 2A mm (90 mm) et 3	STI-02-105.71M	04.310.71M
Manche moyen avec spatule MACINTOSH Taille 2 (78 mm) ou 2A mm (90 mm), 3 et 4	STI-02-106.72M	04.310.72M
Manche moyen avec spatule MACINTOSH Taille 1, 2 (78 mm) ou 2A mm (90 mm), 3 et 4	STI-02-107.73M	04.310.73M
Manche petit avec spatule MILLER Taille 0 et 1	STI-02-108.74M	----
Manche moyen avec spatule MILLER Taille 2, 3 et 4	STI-02-109.75M	----
Manche moyen avec spatule MILLER Taille 1, 2, 3 et 4	STI-02-110.76M	----
Mango mediano con espátula MACINTOSH tamaño 1, 2 (78 mm) o 2A mm (90 mm) y 3	STI-02-111.71M	04.310.71M
Mango mediano con espátula MACINTOSH tamaño 2 (78 mm) o 2A mm (90 mm), 3 y 4	STI-02-112.72M	04.310.72M
Mango mediano con espátula MACINTOSH tamaño 1, 2 (78 mm) o 2A mm (90 mm), 3 y 4	STI-02-113.73M	04.310.73M
Mango pequeño con espátula MILLER tamaño 0 y 1	STI-02-114.74M	----
Mango mediano con espátula MILLER tamaño 2, 3, y 4	STI-02-115.75M	----
Mango mediano con espátula MILLER tamaño 1, 2, 3 y 4	STI-02-116.76M	----
Manico medio con spatola MACINTOSH misura 1, 2 (78 mm) o 2A mm (90 mm) e 3	STI-02-117.71M	04.310.71M
Manico medio con spatola MACINTOSH misura 2 (78 mm) o 2A mm (90 mm), 3 e 4	STI-02-118.72M	04.310.72M
Manico medio con spatola MACINTOSH misura 1, 2 (78 mm) o 2A mm (90 mm), 3 e 4	STI-02-119.73M	04.310.73M
Manico piccolo con spatola MILLER misura 0 e 1	STI-02-120.74M	----
Manico medio con spatola MILLER misura 2, 3 e 4	STI-02-121.75M	----
Manico medio con spatola MILLER misura 1, 2, 3 e 4	STI-02-122.76M	----

Delta Lite Spatel können mit oder ohne Lampen geliefert werden.
Delta Lite blades can be supplied with or without lamps.
 Les spatules **Delta Lite** peuvent être livrées avec ou sans ampoules.
 Las espátulas **Delta Lite** pueden ser suministradas con o sin bombilla.
 Le spatole **Delta Lite** vengono fornite, a vostra scelta, con o senza lampade.



Spatel
Blades
Spatules
Espátulas
Spatole

MACINTOSH

Größe Size Taille Tamaño Misura	Arbeitslänge mm Working Length mm Longueur de travail mm Largo de trabajo mm Lunghezza di lavoro mm	Kat. Nr. Order Code Cat. No. No. Cat. Cat. No.	Kat. Nr. Order Code Cat. No. No. Cat. Cat. No.	Ersatzlampe Spare Lamp Ampoule de rechange Bombilla de repuesto Lampada di ricambio
0	55	STI-02-123.00M	STI-02-130.00S	STI-02-137.71
1	70	STI-02-124.01M	STI-02-131.01S	STI-02-138.72
2	78	STI-02-125.02M	STI-02-132.02S	STI-02-139.72
2A	90	STI-02-126.02M	STI-02-133.02S	STI-02-140.72
3	108	STI-02-127.03M	STI-02-134.03S	STI-02-141.72
4	133	STI-02-128.04M	STI-02-135.04S	STI-02-142.72
5	150	STI-02-129.05M	STI-02-136.05S	STI-02-143.72

Alle Spatel sind in S = Seidenmatt oder M = glänzend erhältlich.
 All blades are available in S = Satin or M = Mirror finish.
 Toutes les spatules sont disponibles en S = mat ou en M = brillant.
 Todas las espátulas disponibles en versión S = satinada o M = pulida.
 Tutte le spatole sono disponibili nella versione S = opaca o M = lucida.

Delta Lite Spatel können mit oder ohne Lampen geliefert werden.

Delta Lite blades can be supplied with or without lamps.

Les spatules **Delta Lite** peuvent être livrées avec ou sans ampoules.

Las espátulas **Delta Lite** pueden ser suministradas con o sin bombilla.

Le spatole **Delta Lite** vengono fornite, a vostra scelta, con o senza lampade.



Spatel
Blades
Spatules
Espátulas
Spatole

MILLER

Größe Size Taille Tamaño Misura	Arbeitslänge mm Working Length mm Longueur de travail mm Largo de trabajo mm Lunghezza di lavoro mm	Kat. Nr. Order Code Cat. No. No. Cat. Cat. No.	Kat. Nr. Order Code Cat. No. No. Cat. Cat. No.	Ersatzlampe Spare Lamp Ampoule de rechange Bombilla de repuesto Lampada di ricambio
0	55	STI-02-144.00M	STI-02-149.00S	STI-02-154.71
1	80	STI-02-145.01M	STI-02-150.01S	STI-02-155.71
2	130	STI-02-146.02M	STI-02-151.02S	STI-02-156.72
3	170	STI-02-147.03M	STI-02-152.03S	STI-02-157.72
4	180	STI-02-148.04M	STI-02-153.04S	

Alle Spatel sind in S = Seidenmatt oder M = glänzend erhältlich.

All blades are available in S = Satin or M = Mirror finish.

Toutes les spatules sont disponibles en S = mat ou en M = brillant.

Todas las espátulas disponibles en versión S = satinada o M = pulida.

Tutte le spatole sono disponibili nella versione S = opaca o M = lucida.



Alle Griffe sind in S = Seidenmatt oder
 M = glänzend erhältlich.
 All handles are available in S = Satin or
 M = Mirror finish.
 Toutes les poignées sont disponibles en S = mat ou en
 M = brillant.
 Todos los mangos disponibles en versión S = satinada o
 M = pulida.
 Tutti i manici sono disponibili nella versione S = opaca o
 M = lucida.

Griffe
Handles
Poignées
Mangos
Manici

**MACINTOSH
 MILLER**

Größe Size Taille Tamaño Misura	Kat. Nr. Order Code Cat. No. No. Cat. Cat. No.	Kat. Nr. Order Code Cat. No. No. Cat. Cat. No.
Griff mittel, (Lieferung ohne Batterien)	STI-02-159.50M	STI-02-179.50S
Griff klein, (Lieferung ohne Batterien)	STI-02-160.51M	STI-02-180.51S
Kurzgriff, (Lieferung ohne Batterien)	STI-02-161.52M	STI-02-181.52S
Griff groß, (Lieferung ohne Batterien)	STI-02-162.53M	STI-02-182.53S
Medium Handle, (supplied without batteries)	STI-02-163.50M	STI-02-183.50S
Small Handle, (supplied without batteries)	STI-02-164.51M	STI-02-184.51S
Stubby Handle, (supplied without batteries)	STI-02-165.52M	STI-02-185.52S
Large Handle, (supplied without batteries)	STI-02-166.53M	STI-02-186.53S
Manche moyen, (livrée sans piles)	STI-02-167.50M	STI-02-187.50S
Manche petit, (livrée sans piles)	STI-02-168.51M	STI-02-188.51S
Manche court, (livrée sans piles)	STI-02-169.52M	STI-02-189.52S
Manche grand, (livrée sans piles)	STI-02-170.53M	STI-02-190.53S
Mango mediano, (suministro sin baterías)	STI-02-171.50M	STI-02-191.50S
Mango pequeño, (suministro sin baterías)	STI-02-172.51M	STI-02-192.51S
Mango corte, (suministro sin baterías)	STI-02-173.52M	STI-02-193.52S
Mango grande, (suministro sin baterías)	STI-02-174.53M	STI-02-194.53S
Manico medio, (consegna senza batterie)	STI-02-175.50M	STI-02-195.50S
Manico piccolo, (consegna senza batterie)	STI-02-176.51M	STI-02-196.51S
Manico corte, (consegna senza batterie)	STI-02-177.52M	STI-02-197.52S
Manico grande, (consegna senza batterie)	STI-02-178.53M	STI-02-198.53S



Scalpels Knives

Skalpеллgriffe
 Scalpel Handles
 Manches de bistouris
 Mangos de bisturíes
 Manici per bisturi

Skalpеллgriffe, passend für
 auswechselbare Skalpelklingen
 Fig. 10, 11, 12, 13, 15

Scalpel Handles for scalpel
 blades fig. 10, 11, 12, 13, 15

Manches pour bistouris, allant
 avec les lames de bistouris
 interchangeables
 fig. 10, 11, 12, 13, 15

Mangos de bisturí para
 hojas intercambiables
 fig. 10, 11, 12, 13, 15

Manici per bisturi, per fissare
 le lame intercambiabili
 fig. 10, 11, 12, 13, 15

lang
 long
 long
 largo
 lungo

abgewinkelt, lang
 angled, long
 coudé, long
 angulado, largo
 angolare, lungo



STI-03-199
 Fig. 3
 12 cm

Heftprofil wie Griff Fig. 4
 handle style as fig. 4
 manche selon fig. 4
 mango como fig. 4
 manico come fig. 4



STI-03-200
 Fig. 3
 12 cm

mit Zentimeter-Graduierung
 cm-graduation
 gradué en cm
 graduado en cm
 graduato in cm



STI-03-201
 Fig. 3
 12 cm



STI-03-202
 Fig. 3 L
 21,5 cm



STI-03-203
 Fig. 3 L
 21 cm

Skalpellgriffe, passend für
 auswechselbare Skalpellschlingen
 Fig. 10, 11, 12, 13, 15

Scalpel Handles for scalpel
 blades fig. 10, 11, 12, 13, 15

Manches pour bistouris, allant
 avec les lames de bistouris
 Interchangeables
 fig. 10, 11, 12, 13, 15

Mangos de bisturi para
 hojas intercambiables
 fig. 10, 11, 12, 13, 15

Manici per bisturi, per fissare
 le lame intercambiabili
 fig. 10, 11, 12, 13, 15

rund
 round
 rond
 redondo
 rotondo

rund, abgewinkelt
 round, angled
 rond, coudé
 redondo, angulado
 rotondo, angolare

rund
 round
 rond
 redondo
 rotondo



Fig. 3
 14,5 cm
 STI-03-204



Fig. 3
 14 cm
 STI-03-205



Fig. 3
 15 cm
 STI-03-206

Skalpelligriffe
 Scalpel Handles
 Manches de bistouris
 Mangos de bisturíes
 Manici per bisturi

Skalpelligriffe, passend für
 auswechselbare Skalpellklingen
 Fig. 10, 11, 12, 13, 15

Scalpel Handles for scalpel
 blades fig. 10, 11, 12, 13, 15

Manches pour bistouris, allant
 avec les lames de bistouris
 interchangeables
 fig. 10, 11, 12, 13, 15

Mangos de bisturi para
 hojas intercambiables
 fig. 10, 11, 12, 13, 15

Manici per bisturi, per fissare
 le lame intercambiabili
 fig. 10, 11, 12, 13, 15

mit rundem Hohlheft
 with round hollow handle
 avec manche creux rond
 con mango hueco redondo
 con manico vuoto, rotondo

lang
 long
 long
 largo
 lungo

lang
 long
 long
 largo
 lungo

kurz
 short
 corto
 court
 corto

mit Kunststoffheft
 with plastic handle
 avec manche en
 matière plastique
 con mango plástico
 con manico di materia
 plastica



STI-03-207
 Fig. 3
 12,5 cm



STI-03-208
 Fig. 3
 15,5 cm



STI-03-209
 Fig. 5
 16 cm



STI-03-210
 Fig. 5
 21,5 cm



STI-03-211
 Fig. 7
 16 cm



STI-03-212
 Fig. 7 K
 12,5 cm

Skalpеллgriffe, passend für
 auswechselbare Skalpеллklingen
 Fig. 10, 11, 12, 13, 15

Scalpel Handles for scalpel
 blades fig. 10, 11, 12, 13, 15

Manches pour bistouris, allant
 avec les lames de bistouris
 interchangeables
 fig. 10, 11, 12, 13, 15

Mangos de bisturios para
 hojas intercambiables
 fig. 10, 11, 12, 13, 15

Manici per bisturi, per fissare
 le lame intercambiabili
 fig. 10, 11, 12, 13, 15



STI-03-213
 21 cm



STI-03-214
 Fig. 3 + 4
 16 cm

Skalpеллgriff, passend für
 auswechselbare Skalpеллklingen
 Fig. 10 - 36

Scalpel Handle for scalpel
 blades fig. 10 - 36

Manche pour bistouri, allant
 avec les lames de bistouris
 interchangeables
 fig. 10 - 36

Mango de bisturios para
 hojas intercambiables
 fig. 10 - 36

Manico per bisturi, per fissare
 le lame intercambiabili
 fig. 10 - 36

Doppelgriff Fig. 3 + 4
 double handle fig. 3 + 4
 manche double fig. 3 + 4
 mango doble fig. 3 + 4
 manico doppio fig. 3 + 4

Skalpellklingen, steril
Scalpel Blades, sterile
Lames des bistouris, stériles
Hojas de bisturíes estériles
Lame da bisturi, sterili



STI-03-215



STI-03-216



STI-03-217



STI-03-218



STI-03-219



STI-03-220



In Packungen à 100
In packages of 100 ea
en boîtes de 100 pièces
en cajas de 100 c/u
in scatole di 100 pezzi



STI-03-221
Skalpellklingen-Entferner
Scalpel Blade Remover
Enlève-lame
Quita hojas
Distributore lame

Skalpеллgriffe, passend für
auswechselbare Skalpеллklіngen
Fig. 18, 19, 20, 21, 22, 23, 24, 25, 36

Scalpel Handles for scalpel
blades fig. 18, 19, 20, 21, 22, 23, 24, 25, 36

Manches pour bistouris, allant
avec les lames de bistouris
interchangeables
fig. 18, 19, 20, 21, 22, 23, 24, 25, 36

Mangos de bisturi para
hojas intercambiables
fig. 18, 19, 20, 21, 22, 23, 24, 25, 36

Manici per bisturi, per fissare
le lame intercambiabili
fig. 18, 19, 20, 21, 22, 23, 24, 25, 36

lang
long
long
longo
lungo



STI-03-222
Fig. 4
13,5 cm

mit Zentimeter-Gradulierung
cm-graduation
gradué en cm
graduado en cm
graduato in cm



STI-03-223
Fig. 4
13,5 cm



STI-03-224
21,5 cm



STI-03-225
Fig. 4 L
21 cm



STI-03-226
Fig. 4 L
21 cm

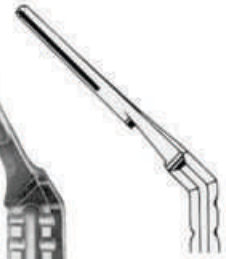

abgewinkelt, lang
angled, long
coudé, long
angulado, largo
angolaro, lungo

auswechselbare Skalpellgriffe
Fig. 18, 19, 20, 21, 22, 23, 24, 25, 36

Scalpel Handles for scalpel
blades fig. 18, 19, 20, 21, 22, 23, 24, 25, 36

Manches pour bistouris, allant
avec les lames de bistouris
interchangeables
fig. 18, 19, 20, 21, 22, 23, 24, 25, 36

Mangos de bisturi para
hojas intercambiables
fig. 18, 19, 20, 21, 22, 23, 24, 25, 36

Manici per bisturi, per fissare
le lame intercambiabili
fig. 18, 19, 20, 21, 22, 23, 24, 25, 36

mit Kunststoffheft
with plastic handle
avec manche en matière plastique
con mango plástico
con manico di materia plastica

mit Hohlfheft
with hollow handle
avec manche creux
con mango hueco
con manico vuoto

mit Hohlfheft
with hollow handle
avec manche creux
con mango hueco
con manico vuoto



STI-03-227
Fig. 4
13,5 cm



COLLIN
STI-03-228
Fig. 8
13,5 cm



COLLIN
STI-03-229
Fig. 9
14,5 cm



STI-03-230



STI-03-231



STI-03-232



STI-03-233



EV-03-234



STI-03-235



STI-03-236



STI-03-237



STI-03-238



In Packungen à 100
 in packages of 100 ea.
 en boîtes de 100 pièces
 en cajas de 100 c/u
 in scatole di 100 pezzi



STI-03-239
 Skalpelling-Entferner
 Scalpel Blade Remover
 Enlève-lame
 Quita hojas
 Distributore lame

Einmalskalpelle, steril
Disposable Scalpels, sterile
Bistouris usage unique, stériles
Bisturios uso único, estériles
Bisturi monouso, sterili



STI-03-240
Fig. 10



STI-03-241
Fig. 11



STI-03-242
Fig. 12



STI-03-243
Fig. 12 d



STI-03-244
Fig. 13



STI-03-245
Fig. 15



STI-03-246
Fig. 15 c

In Packungen à 10 Stück
in packages of 10 ea
en boîtes de 10 pieces
en cajas de 10 c/u
in scatole di 10 pezzi



STI-03-247
 Fig. 18



STI-03-248
 Fig. 19



STI-03-249
 Fig. 20



STI-03-250
 Fig. 21



STI-03-251
 Fig. 22



STI-03-252
 Fig. 23



STI-03-253
 Fig. 24

In Packungen à 10 Stück
 in packages of 10 ea
 en boîtes de 10 pieces
 en cajas de 10 c/u
 in scatole di 10 pezzi

Einmalskalpelle, steril
Disposable Scalpels, sterile
Bistouris usage unique, stériles
Bisturías uso único, estériles
Bisturi monouso, sterili

für Mikro-Skalpellklingen
for micro scalpel blades
pour micro-lame de bisturís
para micro hojas
per micro lame



STI-03-254
13,5 cm



STI-03-255
15,5 cm



CASPAR
STI-03-256
18 cm



STI-03-257
20 cm

Skalpellgriffe, Mikro-Skalpellklingen
 Scalpel Handles, Micro Scalpel Blades
 Manches pour bistouris, Micro lame de bistouris
 Manici per bisturi, Micro lame per bisturi

In Packungen à 10 Stück, steril
 in packages of 10 ea, sterile
 en boîtes de 10 pièces, stériles
 en cajas de 10 c/u, estériles
 in scatole di 10 pezzi, sterili

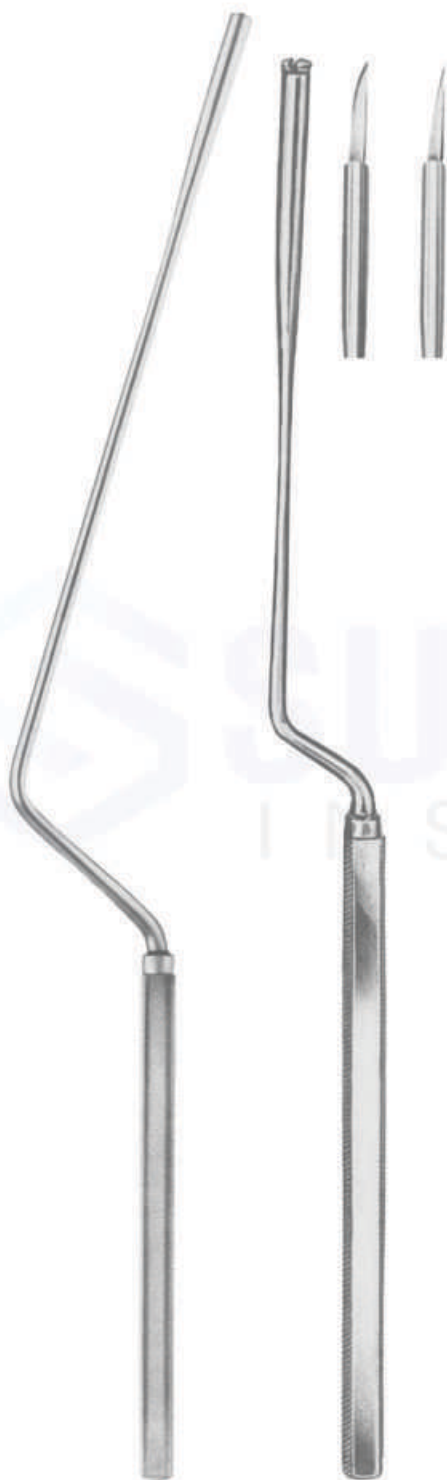

LANDOLT
 STI-03-258
 25 cm

LANDOLT
 STI-03-259
 21 cm



STI-03-260
 #61



STI-03-261
 #62



STI-03-262
 #64



STI-03-263
 #65



STI-03-264
 #67



STI-03-265
 #69



TROUTMAN-CHRIS
STI-03-266
9 cm



**Razor Blade Holder
& Breakers & Removing Forceps**
STI-03-267
11 cm



CASTROVIEJO
STI-03-268
13 cm

mit Metallheft
 with metal handle
 avec manche en métal
 con mango metálico
 con manico di metallo



STI-03-269
 Fig. 1
 15 cm



STI-03-270
 Fig. 2
 15 cm



STI-03-271
 Fig. 3
 15,5 cm



STI-03-272
 Fig. 4
 16 cm



STI-03-273
 Fig. 5
 16 cm



EV-03-280
 PARKER

Fig. 2
 14 cm



STI-03-274
 Fig. 6
 15 cm



STI-03-275
 Fig. 7
 15 cm



STI-03-276
 Fig. 8
 16 cm



STI-03-277
 Fig. 9
 16 cm



STI-03-278
 Fig. 10
 17 cm



STI-03-279
 PARKER

Fig. 1
 14 cm

mit Hohlheft
 with hollow handle
 con mango hueco
 avec manche creux
 con manico vuoto



L = cm	
13	STI-03-281
16	STI-03-282
19	STI-03-283
22	STI-03-284
28	STI-03-285



L = cm	LISTON
17	STI-03-286
20	STI-03-287



L = cm	CATLIN
16	STI-03-288
19	STI-03-289
22	STI-03-290

L = Klingenlänge/length
 of blade/longueur tranchant/
 largo de corte/lunghezza di taglio

massives Heft mit Schaber-Ende
 solid handle, dissecting end
 manche solide à rugine
 mango macizo, con peristótomo
 con manico pieno con raschino



LANGENBECK
STI-03-291
 18 cm



LANGENBECK
STI-03-292
 18 cm



LANGENBECK
STI-03-293
 18 cm

Knorpel-, Hirnmesser
 Cartilage, brain knife
 Couteaux à cartilage, à cerveau
 Cuchillo para cartilagos y p. cerebro
 Coltelli per cartilagini e per il cervello

mit Holzheft
 with wooden handle
 avec manche en bois
 con mango de madera
 con manico di legno

mit Schaber
 with raspator
 avec râpe
 con periostotomo
 con raschiatoio



VIRCHOW
STI-03-294
 25 cm



STI-03-295



STI-03-296



STI-03-297



L = cm	VIRCHOW
16	STI-03-298
20	STI-03-299
24	STI-03-300

Scissors Instruments



SuperCut

TC-Schneiden
 TC Cutting Edges
 Tranchant TC
 Filos de corte TC
 Taglio TC



cm	Standard
10,5	STI-04-301
11,5	STI-04-302
13,0	STI-04-303
14,5	STI-04-304
15,5	STI-04-305
16,5	STI-04-306
18,5	STI-04-307
20,0	STI-04-308



cm	Standard
10,5	STI-04-309
11,5	STI-04-310
13,0	STI-04-311
14,5	STI-04-312
15,5	STI-04-313
16,5	STI-04-314
18,5	STI-04-315
20,0	STI-04-316



cm	Standard
14,5	STI-04-317
16,5	STI-04-318



cm	Standard
14,5	STI-04-319
16,5	STI-04-320

SuperCut

TC-Schneiden
 TC Cutting Edges
 Tranchant TC
 Filos de corte TC
 Taglio TC



cm	Standard
11,5	STI-04-321
13,0	STI-04-322
14,5	STI-04-323
15,5	STI-04-324
16,5	STI-04-325
18,5	STI-04-326
20,0	STI-04-327



cm	Standard
11,5	STI-04-328
13,0	STI-04-329
14,5	STI-04-330
15,5	STI-04-331
16,5	STI-04-332
18,5	STI-04-333
20,0	STI-04-334



cm	Standard
14,5	STI-04-335
16,5	STI-04-336



cm	Standard
14,5	STI-04-337
16,5	STI-04-338

SuperCut

TC-Schneiden
 TC Cutting Edges
 Tranchant TC
 Filos de corte TC
 Taglio TC



cm	MAYO
14,5	STI-04-339
17,0	STI-04-340
23,0	STI-04-341



cm	MAYO
14,5	STI-04-342
17,0	STI-04-343
23,0	STI-04-344



cm	MAYO
14,5	STI-04-345
17,0	STI-04-346
23,0	STI-04-347



cm	MAYO
14,5	STI-04-348
17,0	STI-04-349
23,0	STI-04-350

SuperCut



cm	DEAVER
14,0	STI-04-351 STI-04-352

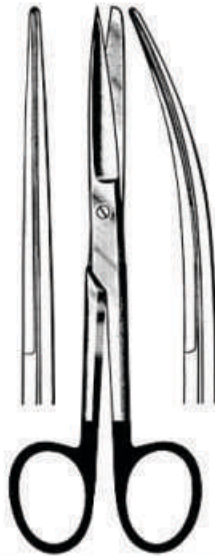

cm	DEAVER
14,0	STI-04-353 STI-04-354



cm	DEAVER
14,0	STI-04-355 STI-04-356

TC-Schneiden
 TC Cutting Edges
 Tranchant TC
 Filos de corte TC
 Taglio TC



cm	DEAVER
14,0	STI-04-357 STI-04-358



cm	DEAVER
14,0	STI-04-359 STI-04-360



cm	DEAVER
14,0	STI-04-361 STI-04-362

SuperCut

TC-Schneiden
 TC Cutting Edges
 Tranchant TC
 Filos de corte TC
 Taglio TC



cm	MAYO
14,5	STI-04-363
17,0	STI-04-364
23,0	STI-04-365



cm	MAYO
14,5	STI-04-366
17,0	STI-04-367
23,0	STI-04-368



cm	MAYO
14,5	STI-04-369
17,0	STI-04-370
23,0	STI-04-371



cm	MAYO
14,5	STI-04-372
17,0	STI-04-373
23,0	STI-04-374

SuperCut

TC-Schneiden
 TC Cutting Edges
 Tranchant TC
 Filos de corte TC
 Taglio TC



cm MAYO-STILLE
 15,0 **STI-04-375**
 17,0 **STI-04-376**

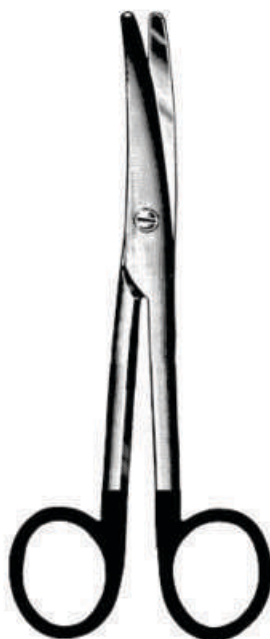

cm MAYO-STILLE
 15,0 **STI-04-377**
 17,0 **STI-04-378**



cm MAYO-STILLE
 15,0 **STI-04-379**
 17,0 **STI-04-380**



cm MAYO-STILLE
 15,0 **STI-04-381**
 17,0 **STI-04-382**

SuperCut

TC-Schneiden
TC Cutting Edges
Tranchant TC
Filos de corte TC
Taglio TC

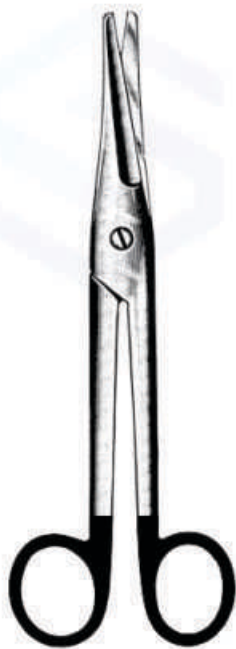

cm MAYO-NOBLE
17,0 STI-04-383



cm MAYO-NOBLE
17,0 STI-04-384



cm MAYO-NOBLE
17,0 STI-04-385



cm MAYO-NOBLE
17,0 STI-04-386

SuperCut

TC-Schneiden
 TC Cutting Edges
 Tranchant TC
 Filos de corte TC
 Taglio TC



cm LEXER
 16,0 STI-04-387
 21,0 STI-04-388

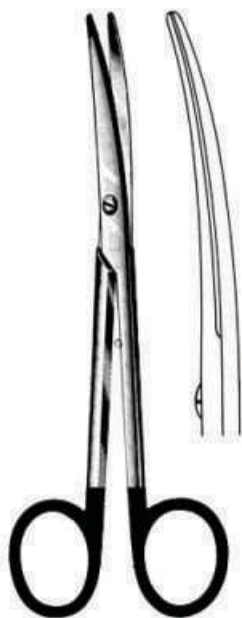

cm LEXER
 16,0 STI-04-389
 21,0 STI-04-390



cm LEXER
 16,0 STI-04-391
 21,0 STI-04-392



cm LEXER
 16,0 STI-04-393
 21,0 STI-04-394

SuperCut

TC-Schneiden
TC Cutting Edges
Tranchant TC
Filos de corte TC
Taglio TC



cm LEXER-BABY
10,0 STI-04-395



cm LEXER-BABY
10,0 STI-04-396



cm LEXER-BABY
10,0 STI-04-397



cm LEXER-BABY
10,0 STI-04-398

SuperCut

TC-Schneiden
 TC Cutting Edges
 Tranchant TC
 Filos de corte TC
 Taglio TC



cm	METZENBAUM
11,5	STI-04-399
15,0	STI-04-400
18,0	STI-04-401
20,0	STI-04-402
23,0	STI-04-403
25,0	STI-04-404
28,0	STI-04-405
30,0	STI-04-406



cm	METZENBAUM
11,5	STI-04-407
15,0	STI-04-408
18,0	STI-04-409
20,0	STI-04-410
23,0	STI-04-411
25,0	STI-04-412
28,0	STI-04-413
30,0	STI-04-414



cm	METZENBAUM
11,5	STI-04-415
15,0	STI-04-416
18,0	STI-04-417
20,0	STI-04-418
23,0	STI-04-419
25,0	STI-04-420
28,0	STI-04-421
30,0	STI-04-422



cm	METZENBAUM
11,5	STI-04-423
15,0	STI-04-424
18,0	STI-04-425
20,0	STI-04-426
23,0	STI-04-427
25,0	STI-04-428
28,0	STI-04-429
30,0	STI-04-430

SuperCut

TC-Schneiden
 TC Cutting Edges
 Tranchant TC
 Filos de corte TC
 Taglio TC



cm	METZENBAUM FINO
15,0	STI-04-431
18,0	STI-04-432
20,0	STI-04-433
23,0	STI-04-434
25,0	STI-04-435
28,0	STI-04-436

cm	METZENBAUM FINO
15,0	STI-04-437
18,0	STI-04-438
20,0	STI-04-439
23,0	STI-04-440
25,0	STI-04-441
28,0	STI-04-442

cm	METZENBAUM FINO
15,0	STI-04-443
18,0	STI-04-444
20,0	STI-04-445
23,0	STI-04-446
25,0	STI-04-447
28,0	STI-04-448

cm	METZENBAUM FINO
15,0	STI-04-449
18,0	STI-04-450
20,0	STI-04-451
23,0	STI-04-452
25,0	STI-04-453
28,0	STI-04-454

SuperCut



cm METZENBAUM "S"
18,0 STI-04-455



cm SANVENERO
14,0 STI-04-456



cm SANVENERO
14,0 STI-04-457



cm METZENBAUM "S"
18,0 STI-04-458



cm SANVENERO
14,0 STI-04-459



cm SANVENERO
14,0 STI-04-460

TC-Schneiden
 TC Cutting Edges
 Tranchant TC
 Filos de corte TC
 Taglio TC

SuperCut

Plastik - Plastic - Plastique - Plástica - Plastica



cm JOSEPH
14,0 STI-04-461



cm JOSEPH
14,0 STI-04-462



cm KILNER
12,0 STI-04-463
15,0 STI-04-464

TC-Schneiden
TC Cutting Edges
Tranchant TC
Filos de corte TC
Taglio TC



cm JOSEPH
14,0 STI-04-465



cm JOSEPH
14,0 STI-04-466



cm KILNER
12,0 STI-04-467
15,0 STI-04-468

SuperCut

rund
round
rond
redondo
retondo



cm	IRIS-Standard
9,0	STI-04-469
10,5	STI-04-470
11,5	STI-04-471



cm	IRIS-Standard
9,0	STI-04-472
10,5	STI-04-473
11,5	STI-04-474



cm	IRIS-Standard
9,0	EV-04-475
10,5	EV-04-476
11,5	EV-04-477



cm	IRIS-Standard
9,0	STI-04-478
10,5	STI-04-479
11,5	STI-04-480

TC-Schneiden
TC Cutting Edges
Tranchant TC
Filos de corte TC
Taglio TC



cm	IRIS-Standard
9,0	STI-04-481
10,5	STI-04-482
11,5	STI-04-483



cm	IRIS-Standard
9,0	STI-04-484
10,5	STI-04-485
11,5	STI-04-486

SuperCut

rund
 round
 rond
 redondo
 retondo

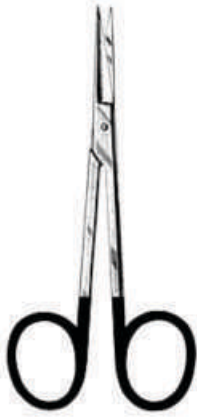

cm	IRIS-Standard
9,0	STI-04-487
10,5	STI-04-488
11,5	STI-04-489



cm	IRIS-Standard
9,0	STI-04-490
10,5	STI-04-491
11,5	STI-04-492



cm	IRIS-Standard
9,0	STI-04-493
10,5	STI-04-494
11,5	STI-04-495



cm	IRIS-Standard
9,0	STI-04-496
10,5	STI-04-497
11,5	STI-04-498

TC-Schneiden
 TC Cutting Edges
 Tranchant TC
 Filos de corte TC
 Taglio TC



cm	IRIS-Standard
9,0	STI-04-499
10,5	STI-04-500
11,5	STI-04-501



cm	IRIS-Standard
9,0	STI-04-502
10,5	STI-04-503
11,5	STI-04-504

SuperCut



cm HEYMANN
18,0 STI-04-505



cm FOMON
15,0 STI-04-506



cm COTTLE
16,0 STI-04-507

SuperCut



POTTS-SMITH

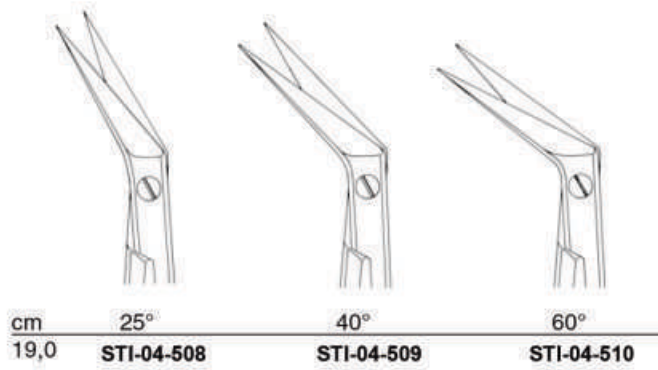

POTTS-SMITH

TC-Schneiden
 TC Cutting Edges
 Tranchant TC
 Filos de corte TC
 Taglio TC

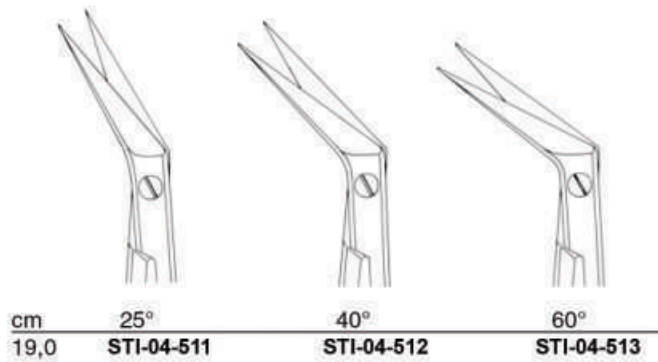

TC-Schneiden
 TC Cutting Edges
 Tranchant TC
 Filos de corte TC
 Taglio TC

Parametrium



cm
 22,0 STI-04-514



cm
 23,0 STI-04-515

TC-Schneiden
TC Cutting Edges
Tranchant TC
Filos de corte TC
Taglio TC



cm LISTER
14,0 **STI-04-516**
18,0 **STI-04-517**
20,0 **STI-04-518**



cm LISTER
14,0 **STI-04-519**
18,0 **STI-04-520**
20,0 **STI-04-521**

SuperCut

Episiotomie
Episiotomy
Episiotomie
Episiotmía
Episiotomia



cm KELLY
16,0 STI-04-522
18,0 STI-04-523



cm KELLY
16,0 STI-04-524
18,0 STI-04-525



cm BRAUN-STADLER
14,5 STI-04-526
22,0 STI-04-527



cm WAGNER
12,0 STI-04-528



cm WAGNER
20,0 STI-04-529

TC-Schneiden
TC Cutting Edges
Tranchant TC
Filos de corte TC
Taglio TC



cm	LISTER
14,0	STI-04-530
18,0	STI-04-531
20,0	STI-04-532



cm	LISTER
14,0	STI-04-533
18,0	STI-04-534
20,0	STI-04-535

TC-Schneiden
 TC Cutting Edges
 Tranchant TC
 Filos de corte TC
 Taglio TC

cm	Standard
10,5	STI-04-552
11,5	STI-04-553
13,0	STI-04-554
13,0	STI-04-555
14,5	STI-04-556
14,5	STI-04-557
15,5	STI-04-558
16,5	STI-04-559
18,5	STI-04-560
20,0	STI-04-561



cm	Standard
10,5	STI-04-562
11,5	STI-04-563
13,0	STI-04-564
13,0	STI-04-565
14,5	STI-04-566
14,5	STI-04-567
15,5	STI-04-568
16,5	STI-04-569
18,5	STI-04-570
20,0	STI-04-571



cm	Standard TC
14,5	STI-04-572
16,5	STI-04-573
18,5	STI-04-574



cm	Standard TC
14,5	STI-04-575
16,5	STI-04-576
18,5	STI-04-577

 (L) = Für Linkshänder / For left-handed
 Pour la main gauche / Para zurdo / Per mancini

TC-Schneiden
 TC Cutting Edges
 Tranchant TC
 Filos de corte TC
 Taglio TC



cm	Standard
10,5	STI-04-578
11,5	STI-04-579
13,0	STI-04-580
14,5	STI-04-581
15,5	STI-04-582
16,5	STI-04-583
18,5	STI-04-584
20,0	STI-04-585



cm	Standard
10,5	STI-04-586
11,5	STI-04-587
13,0	STI-04-588
14,5	STI-04-589
15,5	STI-04-590
16,5	STI-04-591
18,5	STI-04-592
20,0	STI-04-593



cm	Standard TC
14,5	STI-04-594
16,5	STI-04-595
18,5	STI-04-596



cm	Standard TC
14,5	STI-04-597
16,5	STI-04-598
18,5	STI-04-599

schlanke Modelle
 slender patterns
 modèles fins
 modelos fins
 modelli fini



cm
 12,0 **STI-04-600**



cm
 12,0 **STI-04-601**



cm
 12,0 **STI-04-602**
 13,0 **STI-04-603**



cm
 12,0 **STI-04-604**
 13,0 **STI-04-605**

Inzisionsscheren
 Incision scissors
 Ciseaux à incision
 Tijeras para incision
 Forbici incisione



cm
 14,0 **STI-04-606**

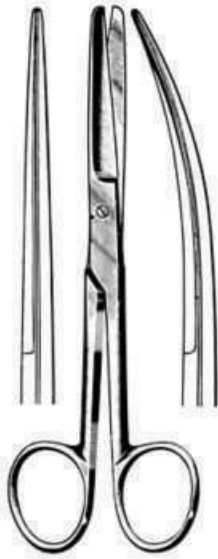

cm — DEAVER —
 14,0 STI-04-607 STI-04-608



cm — DEAVER —
 14,0 STI-04-609 STI-04-610



cm — DEAVER —
 14,0 STI-04-611 STI-04-612

TC-Schnelden
 TC Cutting Edges
 Tranchant TC
 Filos de corte TC
 Taglio TC



cm — DEAVER —
 14,0 STI-04-613 STI-04-614



cm — DEAVER —
 14,0 STI-04-615 STI-04-616



cm — DEAVER —
 14,0 STI-04-617 STI-04-618

TC-Schneiden
 TC Cutting Edges
 Tranchant TC
 Filos de corte TC
 Taglio TC

cm	MAYO
14,5	STI-04-619
14,5	STI-04-620
17,0	STI-04-621
17,0	STI-04-622
19,0	STI-04-623
23,0	STI-04-624
28,0	STI-04-625



cm	MAYO
14,5	STI-04-626
14,5	STI-04-627
17,0	STI-04-628
17,0	STI-04-629
19,0	STI-04-630
23,0	STI-04-631
28,0	STI-04-632



cm	MAYO
14,5	STI-04-633
17,0	STI-04-634
23,0	STI-04-635



cm	MAYO
14,5	STI-04-636
17,0	STI-04-637
23,0	STI-04-638

L = Für Linkshänder / For left-handed
 Pour la main gauche / Para zurdo / Per mancini

schlanke Modelle
slender patterns
modèles fins
modelos finos
modelli fini



<u>cm</u>	<u>MAYO-STILLE</u>
16,0	STI-04-639
19,0	STI-04-640
21,5	STI-04-641

<u>cm</u>	<u>MAYO-STILLE</u>
16,0	STI-04-642
19,0	STI-04-643
21,5	STI-04-644

mit abgeschrägten Schneiden
with chamfered blades
avec tranchant biais
filos en declive
con lame inclinate



<u>cm</u>	<u>MAYO-STILLE</u>
14,0	STI-04-645
17,0	STI-04-646

<u>cm</u>	<u>MAYO-STILLE</u>
14,0	STI-04-647
17,0	STI-04-648

TC-Schneiden
 TC Cutting Edges
 Tranchant TC
 Filos de corte TC
 Taglio TC



cm	<u>MAYO-STILLE</u>
15,0	STI-04-649
17,0	STI-04-650



cm	<u>MAYO-STILLE</u>
15,0	STI-04-651
17,0	STI-04-652



cm	<u>MAYO-STILLE</u>
15,0	STI-04-653
17,0	STI-04-654



cm	<u>MAYO-STILLE</u>
15,0	STI-04-655
17,0	STI-04-656

TC-Schneiden
TC Cutting Edges
Tranchant TC
Filos de corte TC
Taglio TC

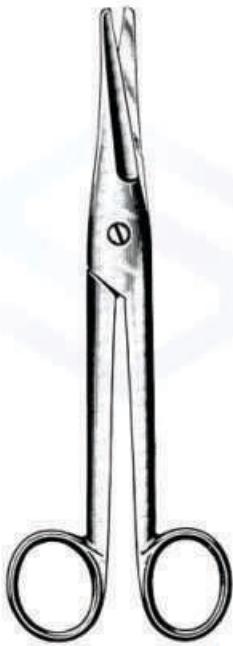

cm MAYO-NOBLE
17,0 STI-04-657

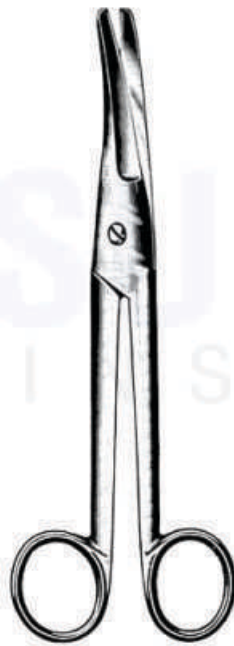

cm MAYO-NOBLE
17,0 STI-04-658



cm MAYO-NOBLE
17,0 STI-04-659

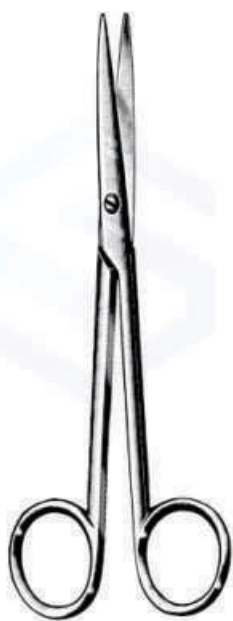

cm MAYO-NOBLE
17,0 STI-04-660

TC-Schneiden
 TC Cutting Edges
 Tranchant TC
 Filos de corte TC
 Taglio TC

cm	LEXER
16,0	STI-04-661
21,0	STI-04-662



cm	LEXER
16,0	STI-04-663
21,0	STI-04-664



cm	LEXER
16,0	STI-04-665
21,0	STI-04-666



cm	LEXER
16,0	STI-04-667
21,0	STI-04-668



cm **LEXER-FINO**
16,0 **STI-04-669**

SURGITECH
INSTRUMENTS

TC-Schneiden
TC Cutting Edges
Tranchant TC
Filos de corte TC
Taglio TC



cm **LEXER-BABY**
10,0 **STI-04-670**



cm **LEXER-BABY**
10,0 **STI-04-671**



cm **LEXER-BABY**
10,0 **STI-04-672**



cm **LEXER-BABY**
10,0 **STI-04-673**

Präparierschere mit Fadenbohrung in der Spitze
 Dissecting scissors, tips with eye for suture
 Ciseaux à dissection avec chas
 Tijera de disección, con ojal en las puntas
 Forbici per dissezione con foro per il filo alla punta



cm LITTLER
 12,0 **STI-04-674**
 14,0 **STI-04-675**



cm METZENBAUM
 11,5 **STI-04-676**
 15,5 **STI-04-677**



cm METZENBAUM
 11,5 **STI-04-678**
 15,5 **STI-04-679**



cm GORNEY
 12,0 **STI-04-680**
 19,0 **STI-04-681**



cm GORNEY
 19,0 **STI-04-682**

TC-Schneiden
 TC Cutting Edges
 Tranchant TC
 Filos de corte TC
 Taglio TC



cm	METZENBAUM
15,0	STI-04-683
15,0	STI-04-684
18,0	STI-04-685
18,0	STI-04-686
20,0	STI-04-687
23,0	STI-04-688
23,0	STI-04-689
25,0	STI-04-690
28,0	STI-04-691
30,0	STI-04-692

cm	METZENBAUM
15,0	STI-04-693
15,0	STI-04-694
18,0	STI-04-695
18,0	STI-04-696
20,0	STI-04-697
23,0	STI-04-698
23,0	STI-04-699
25,0	STI-04-700
28,0	STI-04-701
30,0	STI-04-702

cm	METZENBAUM
15,0	STI-04-703
18,0	STI-04-704
20,0	STI-04-705
23,0	STI-04-706
25,0	STI-04-707
28,0	STI-04-708
30,0	STI-04-709

cm	METZENBAUM
15,0	STI-04-710
18,0	STI-04-711
20,0	STI-04-712
23,0	STI-04-713
25,0	STI-04-714
28,0	STI-04-715
30,0	STI-04-716

L = Für Linkshänder / For left-handed
 Pour la main gauche / Para zurdo / Per mancini

TC-Schneiden
 TC Cutting Edges
 Tranchant TC
 Filos de corte TC
 Taglio TC

cm	METZENBAUM FINO
15,0	STI-04-717
18,0	STI-04-718
20,0	STI-04-719
23,0	STI-04-720
25,0	STI-04-721
28,0	STI-04-722

cm	METZENBAUM FINO
15,0	STI-04-723
18,0	STI-04-724
20,0	STI-04-725
23,0	STI-04-726
25,0	STI-04-727
28,0	STI-04-728

cm	METZENBAUM FINO
15,0	EV-04-729
18,0	EV-04-730
20,0	EV-04-731
23,0	EV-04-732
25,0	EV-04-733
28,0	EV-04-734

cm	METZENBAUM FINO
15,0	EV-04-735
18,0	EV-04-736
20,0	EV-04-737
23,0	EV-04-738
25,0	EV-04-739
28,0	EV-04-740



cm METZENBAUM "S"
18,0 STI-04-741



cm METZENBAUM "S"
18,0 STI-04-742

TC-Schneiden
TC Cutting Edges
Tranchant TC
Filos de corte TC
Taglio TC



cm SANVENERO
14,0 STI-04-743



cm SANVENERO
14,0 STI-04-744



cm JOSEPH
14,0 STI-04-745



cm JOSEPH
14,0 STI-04-746

Plastik
Plastic
Plastique
Plástica
Plastica

Plastik
 Plastic
 Plastique
 Plástica
 Plastica



gerade
 straight
 crochets
 rectas
 rette

cm KILNER
 12,0 **STI-04-747**



cm KILNER
 12,0 **STI-04-748**
 15,0 **STI-04-749**



TC-Schneiden
 TC Cutting Edges
 Tranchant TC
 Filos de corte TC
 Taglio TC

cm KILNER
 12,0 **STI-04-750**
 15,0 **STI-04-751**



eine Schneide gezahnt
 one toothed cutting edge
 une lame dentelée
 una hoja dentada
 una lama dentata



cm LOCKLIN
 16,0 STI-04-752

cm LOCKLIN
 16,0 STI-04-753

Plastik
 Plastic
 Plástica
 Plastica

TC-Schneiden
 TC Cutting Edges
 Tranchant TC
 Filos de corte TC
 Taglio TC



cm REYNOLDS
 15,0 STI-04-754



cm REYNOLDS
 15,0 STI-04-755
 18,0 STI-04-756



cm REYNOLDS
 15,0 STI-04-757



cm REYNOLDS
 15,0 STI-04-758

 cm IRIS
 9,5 STI-04-759

 cm IRIS
 9,5 STI-04-760

 cm IRIS
 10,5 STI-04-761

 cm IRIS
 9,5 STI-04-762

Präparierscheren
 Dissecting Scissors
 Ciseaux à dissection
 Tijera de disección
 Forbici per dissezione

Unterminierscheren
 Undermining Scissors
 Ciseaux à tunnellation
 Tijera para tunelización
 Forbici per tunnelizzare

 cm
 10,0 STI-04-763

 cm
 10,0 STI-04-764

 cm
 9,5 STI-04-765

 cm
 9,5 STI-04-766



cm KNAPP
10,5 **STI-04-767**



cm KNAPP
10,5 **STI-04-768**



cm KNAPP
10,5 **STI-04-769**



cm KNAPP
10,5 **STI-04-770**



cm KNAPP
10,5 STI-04-771



cm KNAPP
10,5 STI-04-772



cm KNAPP
10,5 STI-04-773



cm KNAPP
10,5 STI-04-774

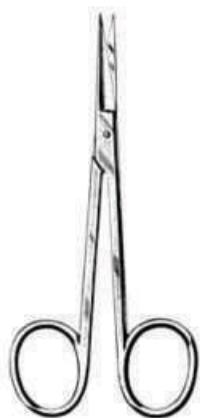

cm	IRIS-Standard
9,0	STI-04-775
10,5	STI-04-776
10,5	STI-04-777
11,5	STI-04-778
12,5	STI-04-779



cm	IRIS-Standard
9,0	STI-04-780
10,5	STI-04-781
10,5	STI-04-782
11,5	STI-04-783
12,5	STI-04-784



cm	IRIS-Standard
10,5	STI-04-785
11,5	STI-04-786

rund
 round
 rond
 redondo
 retondo



cm	IRIS-Standard
10,5	STI-04-787
11,5	STI-04-788

L = Für Linkshänder / For left-handed / Pour la main gauche / Para zurdo / Per mancini

TC-Schneiden
 TC Cutting Edges
 Tranchant TC
 Filos de corte TC
 Taglio TC



cm	IRIS-Standard
11,5	STI-04-789



cm	IRIS-Standard
11,5	STI-04-790

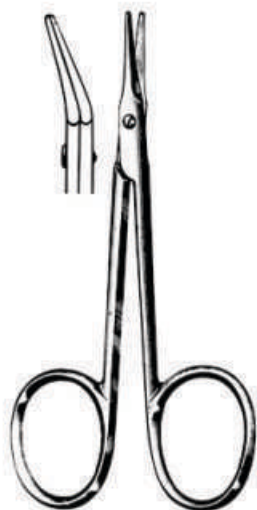

cm AEBLI
 9,0 STI-04-791



cm AEBLI
 9,0 STI-04-792



cm IRIS
 11,5 STI-04-793



cm IRIS
 11,5 STI-04-794



cm STEVENS
10,5 STI-04-795



cm STEVENS
10,5 STI-04-796



cm STEVENS
10,5 STI-04-797



cm STEVENS
10,5 STI-04-798



cm STEVENS
10,5 STI-04-799



cm STEVENS
10,5 STI-04-800



cm STEVENS
10,5 STI-04-801



cm STEVENS
10,5 STI-04-802

 cm
 10,0 STI-04-803

 cm
 12,5 STI-04-804

 Strabimusscheren
 Strabismus scissors
 Ciseaux à strabisme
 Tijeras para estrabismo
 Forbici per strabismo

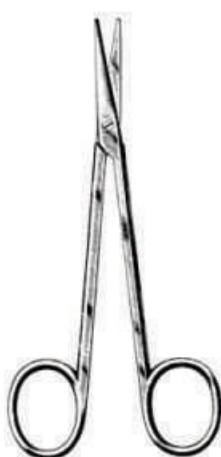
 TC-Schneiden
 TC Cutting Edges
 Tranchant TC
 Filos de corte TC
 Taglio TC

 cm
 11,0 STI-04-805

 cm
 11,0 STI-04-806

 cm
 11,0 STI-04-807

 cm
 11,0 STI-04-808

E nukleationsscheren
 Enucleation scissors
 Ciseaux à énucléation
 Tijeras para enucleación
 Forbici per enucleazione



cm LANDOLT
 11,0 **STI-04-809**
 13,0 **STI-04-810**



cm LANDOLT
 13,0 **STI-04-811**



cm HEYMANN
 18,0 **STI-04-812**



cm FOMON
 14,0 **STI-04-813**



cm FOMON
 15,0 **STI-04-814**



cm COTTLE
 16,0 **STI-04-815**



cm COTTLE
 16,0 **STI-04-816**

TC-Schnelden
 TC Cutting Edges
 Tranchant TC
 Filos de corte TC
 Taglio TC



cm	BEUSE
14,0	STI-04-817
18,0	STI-04-818



cm	BEUSE
14,0	STI-04-819
18,0	STI-04-820



aufgewinkelt
 angled upwards
 coudée en haut
 angulada
 angolari sul piatto

cm	DEAN
17,0	STI-04-821



gezahnt, aufgewinkelt
 toothed, angled upwards
 dentelés, coudée en haut
 dentada, angulada
 dentate, angolari sul piatto

cm	DEAN
17,0	STI-04-822

Tonsillen-, Gefäß-Scheren
Tonsil, Vascular Scissors
Ciseaux amygdal., vasculaires
Tijeras, amígdal., vasculares
Forbici, tonsill., vascolari



cm BOETTCHE
18,0 **STI-04-823**



cm GOOD
19,0 **STI-04-824**



cm PRINCE
17,0 **STI-04-825**



cm
15,0 **STI-04-826**



cm
11,0 **STI-04-827**



cm POTTS-DE MARTEL
21,0 **STI-04-828**
24,0 **STI-04-829**



cm MILLS
22,0 **STI-04-830**



POTTS-SMITH

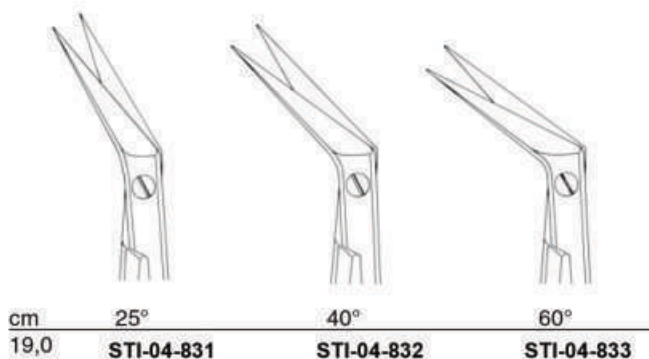

POTTS-SMITH

TC-Schneiden
TC Cutting Edges
Tranchant TC
Filos de corte TC
Taglio TC

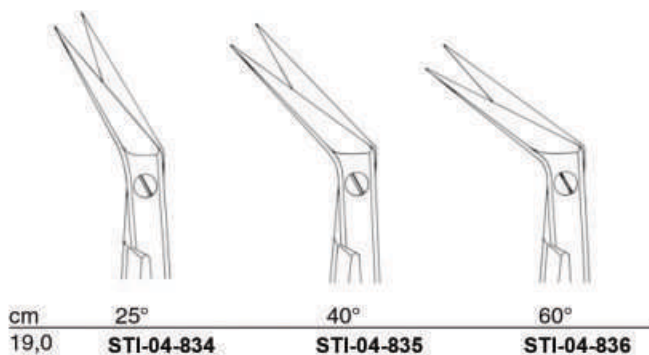



cm DIETHRICH
18,0 **STI-04-837**



cm DIETHRICH
18,0 **STI-04-838**



cm DIETHRICH
18,0 **STI-04-839**



cm DIETHRICH
18,0 **STI-04-840**



cm DIETHRICH
18,0 **STI-04-841**



cm DIETHRICH
18,0 **STI-04-842**

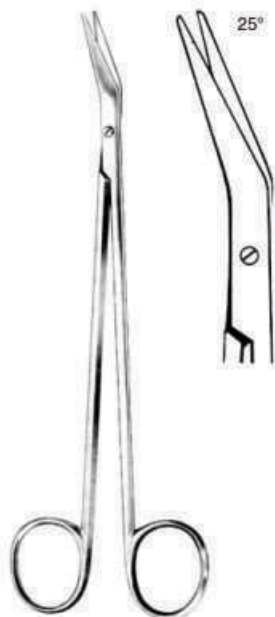

cm DE BAKEY
16,0 STI-04-843
23,0 STI-04-844
28,0 STI-04-845

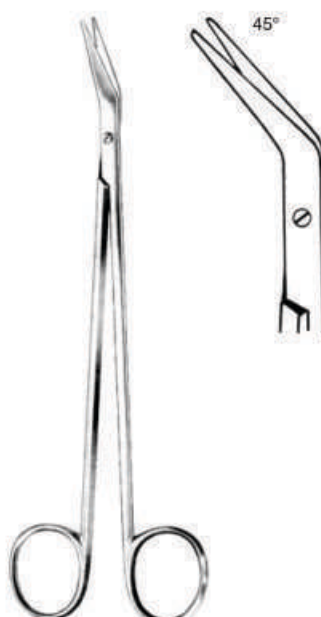

cm DE BAKEY
16,0 STI-04-846
23,0 STI-04-847
28,0 STI-04-848

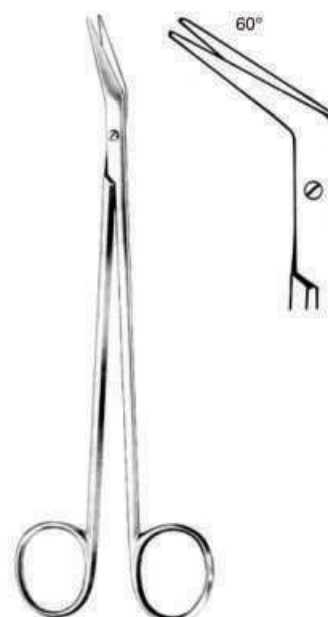

cm DE BAKEY
16,0 STI-04-849
23,0 STI-04-850
28,0 STI-04-851

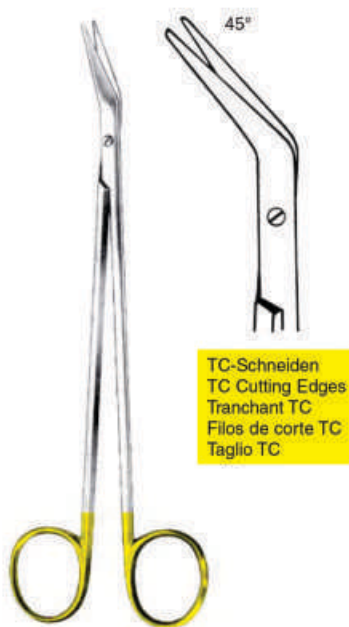

cm DE BAKEY
23,0 STI-04-852



cm DE BAKEY
15,5 STI-04-853

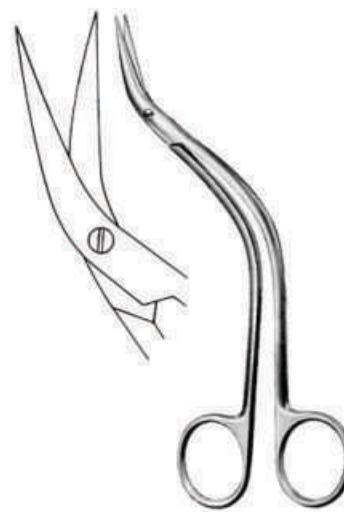

cm DE BAKEY
15,5 STI-04-854

Parametrium



cm
22,5 **STI-04-855**



cm
23,0 **STI-04-856**

TC-Schneiden
TC Cutting Edges
Tranchant TC
Filos de corte TC
Taglio TC



cm
22,5 **STI-04-857**



cm
23,0 **STI-04-858**



cm SIMS
20,0 **STI-04-859**
23,0 **STI-04-860**



cm SIMS
20,0 **STI-04-861**
23,0 **STI-04-862**



cm SIMS
23,0 **STI-04-863**



cm SIMS
23,0 **STI-04-864**

TC-Schneiden
TC Cutting Edges
Tranchant TC
Filos de corte TC
Taglio TC



cm SIEBOLD
24,0 **STI-04-865**



cm WERTHEIM
22,5 **STI-04-866**



cm WERTHEIM
22,5 **STI-04-867**

TC-Schneiden
TC Cutting Edges
Tranchant TC
Filos de corte TC
Taglio TC



cm DOYEN
17,5 STI-04-868
18,5 STI-04-869

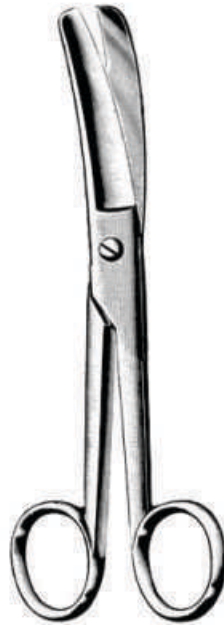

cm DOYEN
17,5 STI-04-870

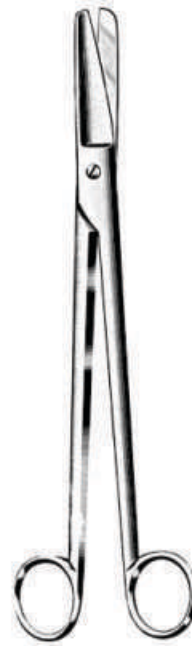

cm DUBOIS
27,0 STI-04-871

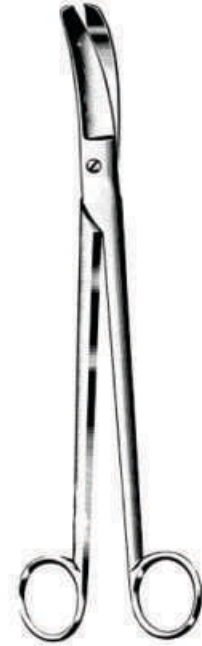

cm DUBOIS
27,0 STI-04-872



cm KELLY
16,0 STI-04-873
18,0 STI-04-874



cm KELLY
16,0 STI-04-875
18,0 STI-04-876

Nabelschnur-Scheren
 Umbilical Scissors
 Ciseaux ombilicaux
 Tijeras umbilicales
 Forbici ombelicali



cm U.S.A Mod.
 10,5 STI-04-877



cm BUSCH
 16,0 STI-04-878



cm SCHUMACHER
 14,0 STI-04-879



cm WALDMANN
 18,0 STI-04-880

Episiotomie
 Episiotomy
 Episiotmie
 Episiotomia
 Episiotomia



cm BRAUN-STADLER
 14,5 STI-04-881
 20,0 STI-04-882
 22,0 STI-04-883

Nerv-Präparierscheren
 Nerve dissecting Scissors
 Ciseaux pour nerfs
 Tijeras para nervios
 Forbici per nervi



cm
 11,0 STI-04-884



cm
 11,0 STI-04-885

Neurochirurgie
Neurosurgery
Neurochirurgie
Neurocirugia
Neurochirurgia



cm
15,0 **STI-04-886**



cm
15,0 **STI-04-887**



cm **STRULLY**
22,0 **STI-04-888**



cm **TOENNIS-ADSON**
18,0 **STI-04-889**



cm **TOENNIS-ADSON**
18,0 **STI-04-890**



cm **MC INDOE**
19,0 **STI-04-891**



cm DANDY
 17,0 **STI-04-892**



cm SCHMIEDEN-TAYLOR
 17,0 **STI-04-893**



cm CRAFOORD
 30,0 **STI-04-894**



cm THOREK
 19,0 **STI-04-895**
 25,0 **STI-04-896**



cm SATINSKY
21,0 STI-04-897

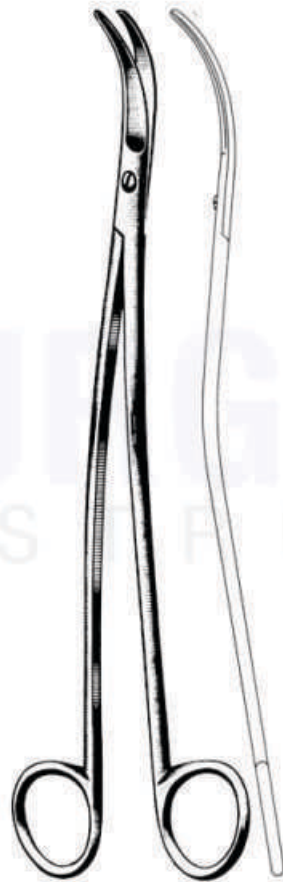

cm SATINSKY
24,5 STI-04-898



cm KLINKENBERG-LOTH
23,0 STI-04-899

Lungenlappen- und Rektumschere
 Lobectomy and rectal scissors
 Ciseaux à lobectomie et pour le rectum
 Tijera para lobectomía y recto
 Forbici per lobo polmonare e per il retto



cm FINOCHIETTO
 27,0 STI-04-900



cm STELZNER
 30,0 STI-04-901



cm STELZNER
 30,0 STI-04-902

Darmscheren
Enterotomy Scissors
Ciseaux à entérotomie
Enterótomos
Forbici per enterotomia

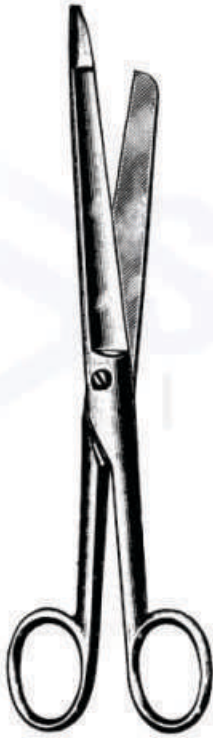

cm
21,0 STI-04-903



cm
21,0 STI-04-904



cm
21,0 STI-04-905

Ligaturscheren
Stitch Scissors
Ciseaux à ligatures
Tijeras para puntas
Forbici per legature



cm	<u>SPENCER</u>
9,0	STI-04-906
11,0	STI-04-907
12,0	STI-04-908
15,0	STI-04-909



cm	<u>SHORTBENT</u>
9,0	STI-04-910



cm	<u>NORTHBENT</u>
13,0	STI-04-911



cm	<u>LITTAUER</u>
14,0	STI-04-912



cm	<u>BUCK</u>
14,5	STI-04-913
18,0	STI-04-914



cm	<u>HEATH</u>
15,0	STI-04-915

Zahnfleischscheren
 Gum Scissors
 Ciseaux à gencives
 Tijeras para encías
 Forbici gengivali



cm
 11,5 **STI-04-916**



cm **LAGRANGE**
 11,5 **STI-04-917**



gezahnt
 serrated
 dentelé
 dentada
 dentellate

cm **LAGRANGE**
 11,5 **STI-04-918**



cm **GOLDMANN-FOX**
 13,0 **STI-04-919**

gezahnt
 serrated
 dentelé
 dentada
 dentellate



cm **GOLDMANN-FOX**
 13,0 **STI-04-920**

TC-Schneiden
 TC Cutting Edges
 Tranchant TC
 Filos de corte TC
 Taglio TC

gezahnt
 serrated
 dentelé
 dentada
 dentellate



cm **GOLDMANN-FOX**
 13,0 **STI-04-921**



cm **GOLDMANN-FOX**
 13,0 **STI-04-922**

Zahnfleissscheren
 Gum Scissors
 Ciseaux à gencives
 Tijeras para encías
 Forbici gengivali

 cm WAGNER
 12,0 **STI-04-923**

 cm WAGNER
 12,0 **STI-04-924**

 cm QUINBY
 12,0 **STI-04-925**

 Draht-, Blechscheren
 Wire and plate shears
 Ciseaux à fils et plaques métalliques
 Tijeras para alambre y chapas
 Forbice per filo metallo lamiera

 cm UNIVERSAL
 12,0 **STI-04-926**

 cm UNIVERSAL
 12,0 **STI-04-927**

 TC-Schneiden
 TC Cutting Edges
 Tranchant TC
 Filos de corte TC
 Taglio TC

Draht-, Blechscheren
 Wire and plate shears
 Ciseaux à fils et plaques métalliques
 Tijeras para alambre y chapas
 Forbice per filo metallo lamiera

gerade
 straight
 droites
 rectas
 rette



cm BEEBE
 10,5 STI-04-928

spitz
 pointed
 pointus
 agudas
 acute



cm BEEBE
 10,5 STI-04-929

gebogen
 curved
 courbes
 curvas
 curve



cm BEEBE
 10,5 STI-04-930

stumpf
 blunt
 mousses
 romas
 smusse



cm BEEBE
 10,5 STI-04-931

gebogen
 curved
 courbes
 curvas
 curve

gerade
 straight
 droites
 rectas
 rette



cm BEEBE
 12,0 STI-04-932

gezahnt
 serrated
 dentelé
 dentada
 dentellate



cm BEEBE
 12,0 STI-04-933

gebogen
 curved
 courbes
 curvas
 curve





cm	LANGE
18,0	EV-04-934

Gaze
 Gauze
 Gaze
 Gaza
 Garza



cm	SMITH US ARMY
15,0	EV-04-935
16,0	EV-04-936
18,0	EV-04-937
20,0	EV-04-938

TC-Schneiden
 TC Cutting Edges
 Tranchant TC
 Filos de corte TC
 Taglio TC



cm	LISTER
9,5	STI-04-939
11,0	STI-04-940
14,0	STI-04-941
14,0	STI-04-942
16,0	STI-04-943
16,0	STI-04-944
18,0	STI-04-945
18,0	STI-04-946
20,0	STI-04-947

cm	LISTER
14,0	STI-04-948

cm	LISTER
18,0	STI-04-949
20,0	STI-04-950

cm	LISTER
14,0	STI-04-951
18,0	STI-04-952
20,0	STI-04-953

L = Für Linkshänder / For left-handed / Pour la main gauche / Para zurdo / Per mancini



cm **BERGMANN**
23,0 **STI-04-954**



cm **ESMARCH**
20,0 **STI-04-955**
22,0 **STI-04-956**



cm **DIMEDA Excenter**
16,0 **STI-04-957**
19,0 **STI-04-958**



cm ROTES KREUZ
17,0 **STI-04-959**



cm KNOWLES
14,0 **STI-04-960**



cm KNOWLES
14,0 **STI-04-961**



cm LORENZ
23,0 **STI-04-962**

eine Schneide gezahnt
one serrated cutting edge
une lame dentelé
una hoja cortante dentada
una lama dentada

TC-Schneiden
TC Cutting Edges
Tranchant TC
Filos de corte TC
Taglio TC



cm BRUNS
23,0 STI-04-963



cm BRUNS
23,0 STI-04-964



cm BRUNS
23,0 STI-04-965

Gipsschere
Plaster Shear
Ciseaux pour plâtre
Tijera para yeso
Forbice per gesso



cm
20,0 STI-04-966



cm FERGUSSON
18,0 STI-04-967

 cm
 14,5 **STI-04-968**

cm UNIVERSAL

	Black	Blue	Green	Red	Yellow	White
15,0	STI-04-969	STI-04-969B	STI-04-969G	STI-04-969R	STI-04-969Y	STI-04-969W
18,0	STI-04-970	STI-04-970B	STI-04-970G	STI-04-970R	STI-04-970Y	STI-04-970W

Ophthalmic Instruments



Sehnen-Scheren
 Tendon Scissors
 Ciseaux tendons
 Tijeras tendones
 Forbici tendini

Iridektomiescheren
 Iridectomy Scissors
 Ciseaux à iridectomie
 Tijeras para iridectomia
 Forbici per iridectomia



spitz
 sharp
 pointu
 agudo
 appuntato



stumpf
 blunt
 mousse
 romo
 smusso



gerade
 straight
 droits
 rectas
 rette



gebogen
 curved
 courbes
 curvas
 curve

cm WESTCOTT
 11,0 STI-05-971

cm WESTCOTT
 11,0 STI-05-972

cm WESTCOTT
 11,0 STI-05-973

cm WESTCOTT
 11,0 STI-05-974

Sehnen-, Iris-Scheren
Tendon, Iris Scissors
Ciseaux à iris et tendons
Tijeras iris y para tendones
Forbici per iride e tendini



cm	NOYES
13,0	STI-05-975
16,0	STI-05-976



spitz/spitz
sharp/sharp
pointu/pointu
agudo/agudo
appuntato/appuntato

Fig. 1



spitz/stumpf
sharp/blunt
pointu/mousse
agudo/romo
appuntato/smusso

Fig. 2



stumpf/stumpf
blunt/blunt
mousse/mousse
romo/romo
smusso/smusso

Fig. 3

cm	NOYES
12,0	STI-05-977

cm	NOYES
12,0	STI-05-978

cm	NOYES
12,0	STI-05-979

Sehnen-, Iris-Scheren
 Tendon, Iris Scissors
 Ciseaux à iris et tendons
 Tijeras iris y para tendones
 Forbici per iride e tendini

spitz/spitz
 sharp/sharp
 pointu/pointu
 agudo/agudo
 appuntato/appuntato

spitz/stumpf
 sharp/blunt
 pointu/mousse
 agudo/romo
 appuntato/smusso

stumpf/stumpf
 blunt/ blunt
 mousse/ mousse
 romo/ romo
 smusso/ smusso



cm WECKER
 11,0 STI-05-980

cm WECKER
 11,0 STI-05-981

cm WECKER
 11,0 STI-05-982

cm WECKER
 11,0 EV-05-980-82



spitz
 sharp
 pointu
 agudo
 appuntato



stumpf
 blunt
 mousse
 romo
 smusso

Blattlänge 10 mm
 length of blades 10 mm
 longueur des lames 10 mm
 largo de hojas 10 mm
 lunghezza della lama 10 mm

cm McPherson-Westcott
 10,0 STI-05-983

cm McPherson-Westcott
 10,0 STI-05-984



cm BARRAQUER
 5,5 STI-05-985

Iridektomie, Hornhaut
Iridectomy, corneal
Iridectomie, cornéens
Iridectomia, corneal
Iridectomia, corneale



cm McGUIRE
10,0 **STI-05-986**



spitz
sharp
pointu
agudo
appuntato

cm CASTROVIEJO
10,0 **STI-05-987**



stumpf
blunt
mousse
romo
smusso

cm CASTROVIEJO
10,0 **STI-05-988**



gerade
straight
droits
rectas
rette

cm VANNAS
8,0 **STI-05-989**



gebogen
curved
courbes
curvas
curve

cm VANNAS
8,0 **STI-05-990**



kniegebogen
angular
coudés
acodadas
angolate

cm VANNAS
8,0 **STI-05-991**

Iridektomie, Hornhaut
 Iridectomy, corneal
 Iridectomie, cornéens
 Iridectomia, corneal
 Iridectomia, corneale



links
 left
 gauche
 izquierda
 sinistra

cm CASTROVIEJO
 10,0 **STI-05-992**



rechts
 right
 droite
 derecha
 destra

cm CASTROVIEJO
 10,0 **STI-05-993**



stumpf
 blunt
 mousse
 romo
 smusso

cm CASTROVIEJO
 11,0 **STI-05-994**



stumpf
 blunt
 mousse
 romo
 smusso

cm CASTROVIEJO
 11,0 **STI-05-995**



stumpf
 blunt
 mousse
 romo
 smusso

cm CASTROVIEJO
 11,0 **STI-05-996**

Mikrochirurgie
 Micro Surgery
 Microchirurgie
 Microcirurgia
 Microchirurgia



cm CASTROVIEJO
 10,0 **STI-05-997**



rechts
right
droite
derecha
destra

cm TROUTMAN-CASTROVIEJO
11,0 **STI-05-998**



links
left
gauche
izquierda
sinistra

cm TROUTMAN-CASTROVIEJO
11,0 **STI-05-999**



gerade
straight
droits
rectas
rette

cm
14,0 **STI-05-1001**
18,0 **STI-05-1002**



gebogen
curved
courbes
curvas
curve

cm
14,0 **STI-05-1003**
18,0 **STI-05-1004**



gerade
straight
droits
rectas
rette

cm
18,0 **STI-05-1005**



stumpf
blunt
mousse
romo
smusso

cm
18,0 **STI-05-1006**



spitz
sharp
pointu
agudo
appuntato



spitz
sharp
pointu
agudo
appuntato



stumpf
blunt
mousse
romo
smusso

cm
14,5 STI-05-1007
18,0 STI-05-1008
23,0 STI-05-1009

cm
14,5 STI-05-1010
18,0 STI-05-1011
23,0 STI-05-1012

cm
14,5 STI-05-1013
18,0 STI-05-1014

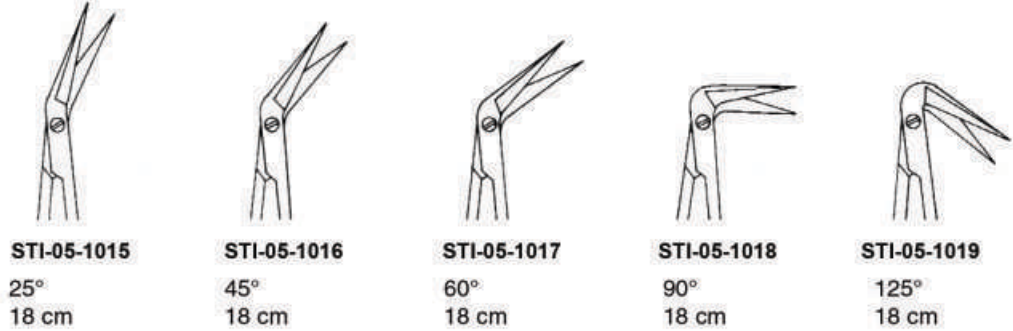

STI-05-1015
25°
18 cm

STI-05-1016
45°
18 cm

STI-05-1017
60°
18 cm

STI-05-1018
90°
18 cm

STI-05-1019
125°
18 cm

spitz
sharp
pointu
agudo
appuntato

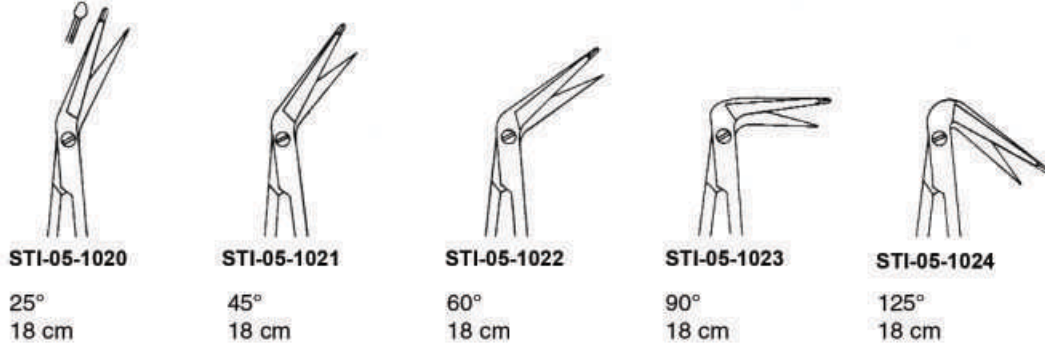

STI-05-1020
25°
18 cm

STI-05-1021
45°
18 cm

STI-05-1022
60°
18 cm

STI-05-1023
90°
18 cm

STI-05-1024
125°
18 cm

1 Blatt geknüpft
1 probe-pointed blade
1 lame boutonnée
1 hoja botonada
1 lama bottonnta

gerade
 straight
 droits
 rectas
 rette



cm YASARGIL
 16,5 STI-05-1025
 20,0 STI-05-1026
 22,5 STI-05-1027

aufgebogen
 upwards curved
 courbe vers le haut
 curvada hacia arriba
 curvato verso l'alto



cm YASARGIL
 16,5 STI-05-1028
 20,0 STI-051029
 22,5 STI-05-1030
 24,5 STI-05-1031

abwärts gebogen
 upwards curved
 courbe en bas
 curvada hacia abajo
 curvato verso il basso



cm YASARGIL
 20,0 STI-05-1032
 22,5 STI-05-1033

stumpf
 blunt
 mousse
 roma
 smusso



cm YASARGIL
 20,0 STI-05-1034
 22,5 STI-05-1035

stumpf
blunt
mousse
romo
smusso



cm YASARGIL
20,0 STI-05-1036
22,5 STI-05-1037

gebogen
curved
courbes
curvas
curve



cm JACOBSON
19,0 STI-05-1038

gerade
straight
droits
rectas
rette



cm YASARGIL
12,0 STI-05-1039
16,0 STI-05-1040
18,0 STI-05-1041

gebogen
curved
courbes
curvas
curve



cm YASARGIL
12,0 STI-05-1042
16,0 STI-05-1043
18,0 STI-05-1044

gerade
straight
droits
rectas
rette

gebogen
curved
courbes
curvas
curve



cm VANNAS
12,0 STI-05-1045
16,0 STI-05-1046

cm VANNAS
12,0 STI-05-1047
16,0 STI-05-1048

gerade
straight
droits
rectas
rette



cm
18,5 STI-05-1049

gebogen
curved
courbes
curvas
curve



cm
18,5 STI-05-1050

gerade
straight
droits
rectas
rette



cm VANNAS
18,5 STI-05-1051

gebogen
curved
courbes
curvas
curve



cm VANNAS
18,5 STI-05-1052

Sperrelevatoren
 Eye Specula
 Blépharostats
 Biefarostatos
 Biefarostati

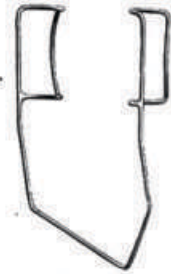

cm **BARRAQUER (Colibri)**
 3 **STI-05-1053**
 4 **STI-05-1054**



BOWMAN
STI-05-1055
 7 cm

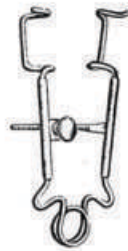

CRITCHETT
STI-05-1056
 7 cm



SMITH
STI-05-1057
 5 cm



CLARK
STI-05-1058
 8 cm



cm **GRAEFE**
 7 **STI-05-1059**
 9 **STI-05-1060**



WEEK
STI-05-1061
 8 cm



ARRUGA
STI-05-1062
 7 cm · rechts ·
 right · à droite ·
 a la derecha ·
 destro

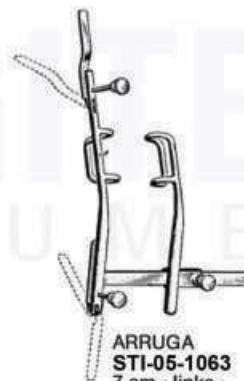

ARRUGA
STI-05-1063
 7 cm · links ·
 left · à gauche ·
 a la izquierda ·
 sinistro

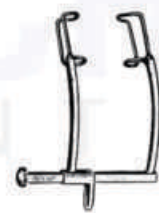

MURDOCK
STI-05-1064
 5 cm



MELLINGER-AXENFELD
STI-05-1065
 7 cm



MELLINGER-AXENFELD
STI-05-1066
 7 cm

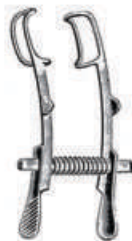

cm **MELLINGER**
 5 **STI-05-1067**
 7 **STI-05-1068**



LISTER-BURCH
STI-05-1069
 8 cm



WILLIAMS
STI-05-1070
 8 cm

Sperrelevatoren
Eye Specula
Blépharostats
Blefarostatos
Blefarostati



LANCASTER
STI-05-1071
7 cm



ZIEGLER
STI-05-1072
7 cm



CASTROVIEJO
STI-05-1073
8 cm



PARK
STI-05-1074
8 cm



MUELLER
STI-05-1075
7 cm



GOLDSTEIN
EV-05-1076
3 cm



STEVENSON
EV-05-1077
7 cm



Lidplatte
Lid Plate
Plaque à paupières
Placa para párpados
Placca per palpebre

JAEGER
EV-05-1078
11 cm

Starmesser
Cataract Knives
Couteaux à cataracte
Cuchillos para catarata
Coltelli per cataratta



GRAEFE
STI-05-1079



STI-05-1080
Fig. 0



STI-05-1081
Fig. 1



STI-05-1082
Fig. 2



STI-05-1083
Fig. 3



DEUSCHMANN
STI-05-1084
13 cm



STI-05-1085



JAEGER
 STI-05-1086 Fig. 1
 STI-05-1087 Fig. 2
 STI-05-1088 Fig. 3



JAEGER 45°
 STI-05-1089 Fig. 1
 STI-05-1090 Fig. 2
 STI-05-1091 Fig. 3



BERENS
 STI-05-1092
 13 cm

CASTROVIEJO
 STI-05-1093
 4 x 13 mm
 13 cm

GRAEFE
 STI-05-1094
 13 cm

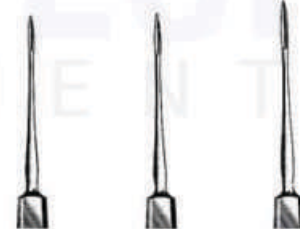

KNAPP
 STI-05-1095 Fig. 1

STI-05-1096 Fig. 2

STI-05-1097 Fig. 3



ZIEGLER

STI-05-1098 Fig. 1
 5 mm

STI-05-1099 Fig. 2
 6 mm

STI-05-1100 Fig. 3
 7 mm



DEAN
 STI-05-1101
 12,5 cm



BOWMAN

STI-05-1102
 0,4 mm
 13 cm

STI-05-1103
 0,8 mm
 13 cm



WHEELER
 STI-05-1104
 12 cm





LA FORCE
 STI-05-1131



DIX
 STI-05-1132



ELLIS
 STI-05-1133



WALTON
 STI-05-1134



WALTON
 STI-05-1135



ALVIS
 STI-05-1136



GREEN
 STI-05-1137



ROLLET
 STI-05-1138



GRAEFE
 STI-05-1139 Fig. 1



STI-05-1140 Fig. 2



STI-05-1141 Fig. 3



JAMESON
 STI-05-1142



GREEN
 STI-05-1143



STEVENS
 STI-05-1144



ARRUGA
 STI-05-1145 Fig. 1



STI-05-1146 Fig. 2



O'CONNOR
 STI-05-1147



WIENER
 STI-05-1148



WIENER
 STI-05-1149



ROLLET
 STI-05-1150



KNAPP
 STI-05-1151



STI-05-1152



GRAEFE
 STI-05-1153



STI-05-1154



BECKER
 STI-05-1155



MEYHOEFER

STI-05-1156	STI-05-1157	STI-05-1158	STI-05-1159	STI-05-1160	STI-05-1161	STI-05-1162	STI-05-1163	STI-05-1164
Ø mm 0,5	1,0	1,5	1,8	2,0	2,5	3,5	4,0	4,5



HEBRA

STI-05-1165	STI-05-1166	STI-05-1167	STI-05-1168	STI-05-1169
Ø mm 1,0	2,0	2,5	3,0	3,5



AXENFELD
STI-05-1170



GRAEFE

STI-05-1171 **STI-05-1172**

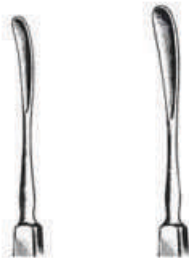

DAVIEL

STI-05-1173 **STI-05-1174**



KNAPP
STI-05-1175



BUNGE

STI-05-1176 **STI-05-1177** **STI-05-1178**



LANG
 STI-05-1179

Iris Spatel
 Iris spatula
 Spatule p. l'iris
 Espatula para Iris
 Spatola p. iride



WECKER
 EV-05-1184 EV-05-1185



CULLER
 EV-05-1186



WELLS
 EV-05-1187



ARRUGA
 EV-05-1188



WADSWORTH-TODD
 EV-05-1189

Schützer
 Protector
 Protecteur
 Protector
 Protettore

Kauter
 Cauter
 Cautère
 Cauterio
 Cauterío



WEBER
 STI-05-1180
 Fig. 1

SNELLEN
 STI-05-1181
 Fig. 2

WILDER
 STI-05-1182
 Fig. 1

ARLT
 STI-05-1183
 Fig. 2

Zyklodialyse · Cyclodialysis · Cyclodialyse · Ciclodíalisis · Ciclodialisi

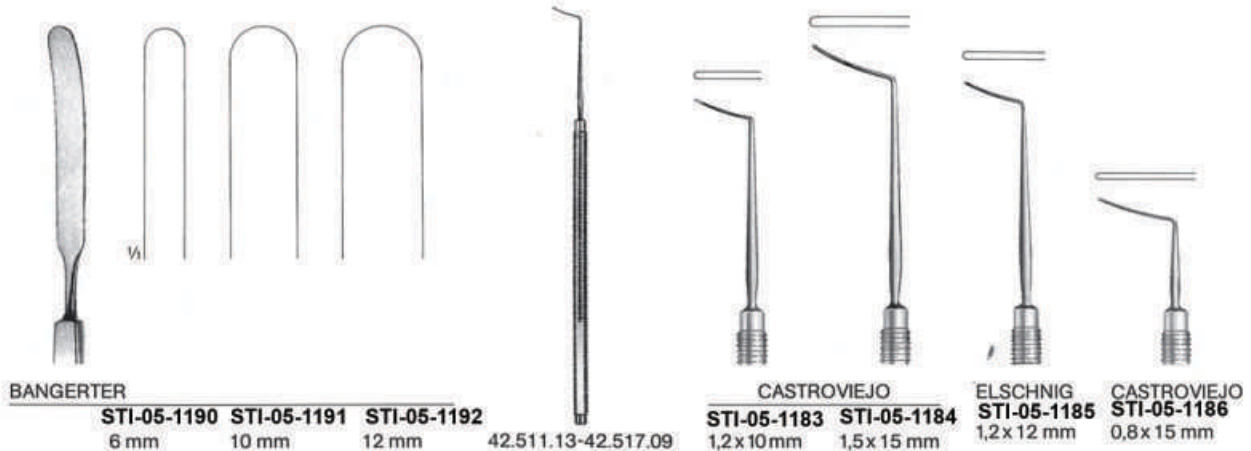

BANGERTER
 STI-05-1190 STI-05-1191 STI-05-1192
 6 mm 10 mm 12 mm

42.511.13-42.517.09

CASTROVIEJO
 STI-05-1183 STI-05-1184
 1,2x10mm 1,5x15 mm

ELSCHNIG
 STI-05-1185
 1,2x12 mm

CASTROVIEJO
 STI-05-1186
 0,8x15 mm



GRAEFE
 STI-05-1187
 10 cm



GRAEFE
 STI-05-1188
 10 cm



GRAEFE
 STI-05-1189
 10 cm



GRAEFE
 STI-05-1190
 10 cm



GRAEFE
 STI-05-1191
 10 cm



GRAEFE
 STI-05-1192
 10 cm



STEVENS
 STI-05-1194
 10,5 cm



STEVENS
 STI-05-1195
 10,5 cm



STEVENS
 STI-05-1196
 10,5 cm



STEVENS
 STI-05-1197
 10,5 cm



STEVENS
 STI-05-1198
 10,5 cm



STEVENS
 STI-05-1193
 10,5 cm

SURGITECH
 INSTRUMENTS

Tränenang-Dilatatoren
 Lachrymal Dilators
 Dilatateurs pour canal lacrymal
 Dilatadores para canal lacrimal
 Dilatatori per canale lacrimale

Tränenkanal-Sonden
 Lachrymal Probes
 Stylets pour le canal lacrymal
 Estiletes para canal lacrimal
 Specilli per canale lacrimale



WILDER
 STI-05-1194 STI-05-1195 STI-05-1196



ZIEGLER
 Fig. 1/2 STI-05-1197
 3/4 STI-05-1198
 5/6 STI-05-1199



CASTROVIEJO
 42.608.12



BOWMAN
 STI-05-1200
 STI-05-1201
 STI-05-1202
 STI-05-1203
 STI-05-1204
 STI-05-1205
 STI-05-1206
 STI-05-1207
 STI-05-1208



BOWMAN
 Fig. 00/0 STI-05-1209
 0/1 STI-05-1210
 1/2 STI-05-1211
 2/3 STI-05-1212
 3/4 STI-05-1213
 4/5 STI-05-1214
 5/6 STI-05-1215
 6/7 STI-05-1216
 7/8 STI-05-1217

Iris-Pinzetten · Iris Forceps ·
 Pincas à iris · Pinzas para iris · Pinze per iride



GRAEFE
 STI-05-1218
 7 cm/1 mm



GRAEFE
 STI-05-1219
 7 cm/1 mm



GRAEFE
 STI-05-1220
 7 cm/1 mm



GRAEFE
 STI-05-1221
 7 cm/1 mm

Fig. 00 0 1 2 3 4 5 6 7 8
 Ø mm 0,7 0,8 0,9 1,1 1,3 1,4 1,5 1,6 1,8 1,9



GRAEFE
STI-05-1222
10 cm



GRAEFE
STI-05-1223
10 cm



GRAEFE
STI-05-1224
10 cm



GRAEFE
STI-05-1225
10 cm



GRAEFE
STI-05-1226
10 cm



GRAEFE
STI-05-1227
10 cm



STEVENS
STI-05-1229
10,5 cm



STEVENS
STI-05-1230
10,5 cm



STEVENS
STI-05-1231
10,5 cm



STEVENS
STI-05-1232
10,5 cm



STEVENS
STI-05-1233
10,5 cm



STEVENS
STI-05-1228
10,5 cm

SURGITECH
INSTRUMENTS



FOERSTER
 STI-05-1234
 8,5 cm



FOERSTER
 STI-05-1235
 8,5 cm



FOERSTER
 STI-05-1236
 8,5 cm



FOERSTER
 STI-05-1237
 8,5 cm



HESS
 STI-05-1238
 7 cm/0,3 mm



HESS
 STI-05-1239
 7 cm/0,3 mm



GILL
 STI-05-1240
 7,5 cm/0,3 mm



GILL-HESS
 STI-05-1241
 7,5 cm/0,3 cm

Zähne unten
 teeth below
 dents en bas
 dientes abajo
 denti in basso



GILL-HESS
 STI-05-1242
 7,5 cm/0,3 cm

Zähne seitwärts
 lateral teeth
 dientes laterales
 dientes laterales
 denti laterali





FISCHER
STI-05-1243
7 cm



BARRAQUER-KATZIN
STI-05-1244
7 cm/0,4 mm



TROUTMAN (Colibri)
STI-05-1245
7 cm/0,12 mm



BARRAQUER (Colibri)
STI-05-1246
7 cm/0,12 mm

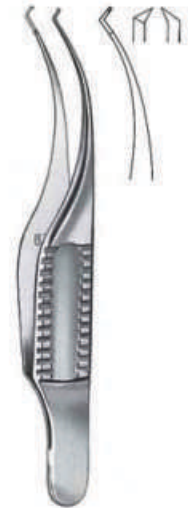

BARRAQUER (Colibri)
STI-05-1247
7 cm / 0,12 mm



KIRBY-ARTHUR
STI-05-1248
9 cm/0,2 mm



KIRBY-ARTHUR
STI-05-1249
9 cm/0,2 mm



McCULLOUGH
STI-05-1250
9,5 cm



McCULLOUGH
STI-05-1251
9,5 cm



JAMESON
STI-05-1252
L, 10 cm

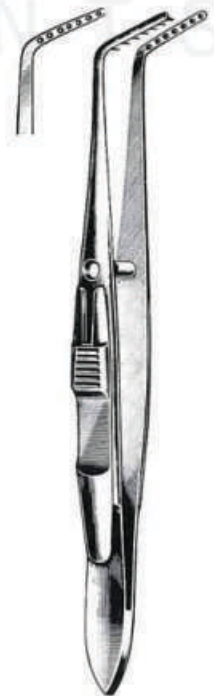

JAMESON
STI-05-1253
R, 10 cm



BONACCOLTO
 STI-05-1254
 10 cm



BONACCOLTO
 STI-05-1255
 10 cm



BONACCOLTO
 STI-05-1256
 11 cm



DASTOOR
 STI-05-1257
 11 cm



DASTOOR
 STI-05-1258
 11 cm



BISHOP-HARMAN
 STI-05-1259
 8,5 cm/0,5 mm



BISHOP-HARMAN
 STI-05-1260
 8,5 cm/0,8 mm



BISHOP-HARMAN
 STI-05-1261
 8,5 cm/0,5 mm



BISHOP-HARMAN
 STI-05-1262
 8,5 cm/0,8 mm

Iris-Pinzetten · Iris Forceps · Pincès à iris ·
 Pinzas para iris · Pinze per iride



Mod. Bonn
 STI-05-1263
 7 cm/0,12 mm



Mod. Bonn
 STI-05-1264
 7 cm/0,12 mm



Iris-, Muskel-Pinzetten · Iris,
 Muscle Forceps · Pincès à iris, mus-
 culaires · Pinzas para iris, muscu-
 lares · Pinze per iride, muscolari

 Mod. Bonn
 STI-05-1265
 10 cm/0,12 mm

 Mod. Tübingen
 STI-05-1266
 STI-05-1267
 10 cm

 Mod. Bonn
 STI-05-1268
 STI-05-1269
 10 cm/0,12 mm

 Mod. Tübingen
 STI-05-1270
 STI-05-1271
 10 cm

 Titan
 Titanium
 Titane
 Titanio
 Titanio



PRINCE
 STI-05-1272
 10 cm

PRINCE
 STI-05-1273
 10 cm

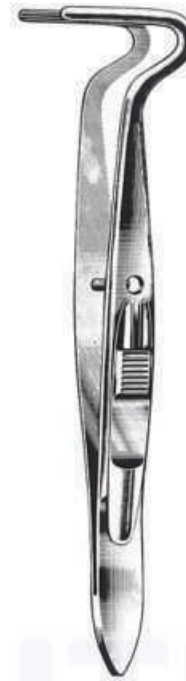

BERKE
 STI-05-1274



STI-10-1323



STI-05-1275

Rectus



TROUTMAN
 STI-05-1276
 8,5 cm/0,8 mm

Vorderkammer-Pinzette
 Anterior Chamber Forceps
 Pince à chambre antérieure
 Pinza para cámara anterior
 Pinza per camera anteriore



BARRAQUER
 STI-05-1277
 5,5 cm/7 mm



ELSCHNIG
STI-05-1278
11 cm



GRAEFE
STI-05-1279



STI-05-1280



EV-05-1281
mit Schloß
with catch
à crémaillère
con cierre
c. cremagliera



LESTER
STI-05-1282
9 cm



CASTROVIEJO
STI-05-1283



CASTROVIEJO
STI-05-1284



CASTROVIEJO
STI-05-1285



CASTROVIEJO
STI-05-1286



BARRAQUER
STI-05-1287
10 cm



GREEN
STI-05-1288
10 cm



STI-05-1289 STI-05-1290
5 mm 10 mm
ohne/without/sans
sin/senza



STI-05-1291 STI-05-1292
5 mm 10 mm
mit/with/avec/con

Schloß / catch /
crémaillère /
cierre/cremagliera



GILL-ARRUGA
STI-05-1293
7,5 cm



TERSON
 STI-05-1294
 9 cm



KALT
 STI-05-1295
 10 cm



ELSCHNIG
 STI-05-1296
 10 cm



ARRUGA
 STI-05-1297
 10 cm



ARRUGA
 STI-05-1298
 10 cm



CASTROVIEJO
 STI-05-1299
 10 cm



SCHWEIGGER
 STI-05-1300
 10 cm



SCHWEIGGER
 STI-05-1301
 10 cm



ELSCHNIG
 STI-05-1302
 10 cm



HESS
 STI-05-1303
 6 cm



HESS
 STI-05-1304
 6,5 cm



FUCHS
 STI-05-1305
 7 cm



Zahn
tooth
dent
diente

CASTROVIEJO

0,12 mm	STI-05-1306	
0,3 mm	STI-05-1307	
0,5 mm	STI-05-1308	STI-05-1309
1,0 mm	STI-05-1310	STI-05-1312
1,5 mm	STI-05-1311	STI-05-1313



MOORFIELD
STI-05-1314
10 cm



St. MARTIN
STI-05-1315
7 cm



Mod. Tübingen
STI-05-1316
STI-05-1317
10 cm



PAUFIQUE
STI-05-1318
STI-05-1319
8,5 cm



PAUFIQUE
STI-05-1320
STI-05-1321
8,5 cm

Titan
Titanium
Titane
Titanio
Titanio



McPHERSON
STI-05-1322
STI-05-1323
10 cm



McPHERSON
STI-05-1324
STI-05-1325
10 cm



AYER
 STI-05-1326
 9 cm



AYER
 STI-05-1327
 9 cm



LAMBERT
 STI-05-1328
 9 cm



DESMARRES
 STI-05-1329
 9 cm



STI-05-1330
 Fig. 1



STI-05-1331
 Fig. 2



STI-05-1332
 Fig. 3



SNELLEN
 STI-05-1333
 10 cm

SNELLEN
 STI-05-1334
 10 cm



KNAPP-LUER
 STI-05-1335
 11 cm



SCHEIE
 STI-05-1336
 1,0 x 28 mm



SCHEIE
 STI-05-1337
 1,5 x 33 mm



Mod. Tübingen
 STI-05-1338



Mod. Hamburga
 STI-05-1339



SIMCOE
 STI-05-1340



Mod. Bonn
 STI-05-1341



Mod. Bonn
 STI-05-1342

Hornhaut-Trephinen · Corneal Trephines
 Trépan cornéens · Trépanos corneales
 Trefine corneali



CASTROVIEJO
 STI-05-1343

Ø mm	CASTROVIEJO
5,0	STI-05-1344
5,5	STI-05-1345
6,0	STI-05-1346
6,5	STI-05-1347
7,0	STI-05-1348
8,0	STI-05-1349
9,0	STI-05-1350
10,0	STI-05-1351
11,0	STI-05-1352



FRANCESCETTI
 STI-05-1353

Ø mm	FRANCESCETTI
5,0	STI-05-1354
5,1	STI-05-1355
6,0	STI-05-1356
6,1	STI-05-1357
7,0	STI-05-1358
7,1	STI-05-1359
8,0	STI-05-1360
8,1	STI-05-1361
9,0	STI-05-1362
9,1	STI-05-1363
10,0	STI-05-1364



ELLIOT
 STI-05-1365
 compl. = 4

Tonometer
 Tonometers
 Tonómetros
 Tonómetros
 Tonometri



SCHIOETZ
 STI-05-1366 STI-05-1367

Skala	gerade	schräg
scale	straight	oblique
échelle	droite	oblique
escala	recta	oblicua
scala	retta	obliqua



STI-05-1368

Augen-Magnet
 Eye Magnet
 Aimant à corps étrangers
 Imán para cuerpos extraños
 Calamita per corpi estranei

Cilien-Pinzetten · Cilia Forceps
 Pinces à épiler les cils · Pinzas
 depilatorias · Pinze depilatorie

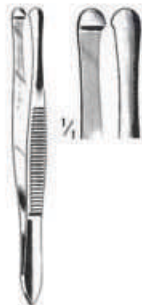

BEER
 STI-05-1369
 9 cm



DOUGLAS
 STI-05-1370
 9 cm



LITTAUER
 STI-05-1371
 8,5 cm



BARRAQUER
 STI-05-1372
 10,5 cm



STI-05-1373
 9 cm



GRADLE
 STI-05-1374
 9,5 cm

Bonn Corneal Forcep
 Very Delicate 1 x 2 Teeth



Catalog #	Size, Tip Size
STI-05-1375	8.5 cm (3 1/4"), 0.12 mm



Bonn Corneal Forcep
 Very Delicate 1 x 2 Teeth With Tying Platform



Catalog #	Size, Tip Size
STI-05-1376	10 cm (4"), 0.12 mm



Bonn Corneal Forcep
 Very Delicate 1 x 2 Teeth With Tying Platform, Titanium



Catalog #	Size, Tip Size
STI-05-1377 T	10 cm (4"), 0.12 mm



McPherson Suture Tying Forcep
 Straight, 1 x 2 Teeth With Tying Platform



Catalog #	Size, Tip Size
STI-05-1378	10.5 cm (4"), 0.4 mm



McPherson Suture Tying Forcep
 Angled, 1 x 2 Teeth With Tying Platform



Catalog #	Size, Tip Size
STI-05-1379	10 cm (4"), 0.4 mm



Kelman-McPherson Tissue Forcep
 1 x 2 Teeth



Catalog #	Size, Jaw Length, Tip Size
STI-05-1380	10 cm (4"), 8 mm, 0.3 mm



Hoffer-McPherson Tissue Forcep
 Very Delicate 1 x 2 Teeth



Catalog #	Size, Jaw Length, Tip Size
STI-05-1381	10 cm (4"), 11 mm, 0.12 mm



Castroviejo Suture Tying Forcep
 1 x 2 Teeth With Tying Platform



Catalog #	Size, Tip Size
STI-05-1382	11 cm (4 1/4"), 0.12 mm
STI-05-1383	11 cm (4 1/4"), 0.3 mm
STI-05-1384	11 cm (4 1/4"), 0.5 mm
STI-05-1385	11 cm (4 1/4"), 0.9 mm



Castroviejo Suture Tying Forcep
 1 x 2 Teeth With Tying Platform, Titanium



Catalog #	Size, Tip Size
STI-05-1386	11 cm (4 1/4"), 0.12 mm



Castroviejo Suture Tying Forcep
 Angled, 1 x 2 Teeth With Tying Platform



Catalog #	Size, Tip Size
STI-05-1387	11 cm (4 1/4"), 0.12 mm
STI-05-1388	11 cm (4 1/4"), 0.3 mm
STI-05-1389	11 cm (4 1/4"), 0.5 mm
STI-05-1390	11 cm (4 1/4"), 0.9 mm



Castroviejo Suture Tying Forcep
 Angled, 1 x 2 Teeth With Tying Platform, Titanium

Catalog #	Size, Tip Size
STI-05-1391	11 cm (4 1/4"), 0.12 mm



Girard Corneoscleral Forcep
 1 x 2 Teeth With Tying Platform, For Right Hand

Catalog #	Size, Tip Size
STI-05-1392	10.5 cm (4"), 0.12 mm



Girard Corneoscleral Forcep
 1 x 2 Teeth With Tying Platform, For Left Hand

Catalog #	Size, Tip Size
STI-05-1393	10.5 cm (4"), 0.12 mm



Bishop-Harmon Iris Forcep
 Delicate 1 x 2 Teeth

Catalog #	Size
STI-05-1394	8.5 cm (3 1/4")



Bishop-Harmon Iris Forcep
 Standard 1 x 2 Teeth

Catalog #	Size
STI-05-1395	8.5 cm (3 1/4")



Bishop-Harmon Dressing Forcep

Cross Serrated Jaws



Catalog #	Size
STI-05-1396	8.5 cm (3 1/4")

Sauer Fixation Forcep

1 x 2 Teeth



Catalog #	Size, Tip Size
STI-05-1397	9 cm (3 1/2"), 0.3 mm

Manhattan Eye & Ear Fixation Forcep

1 x 2 Teeth With Tying Platform



Catalog #	Size, Tip Size
STI-05-1398	9 cm (3 1/2"), 0.3 mm

Elschnig Fixation Forcep

1 x 2 Teeth



Catalog #	Size
STI-05-1399	11 cm (4 1/4")

Graefe Fixation Forcep

Catalog #	Size
STI-05-1400	11 cm (4 1/4")

Troutman Superior Rectus Forcep

Angled, 1 x 2 Teeth



Catalog #	Size
STI-05-1401	11 cm (4 1/4")

McPherson Suture Tying Forcep

Straight, With Tying Platform



Catalog #	Size, Jaw Length
STI-05-1402	10 cm (4"), 5 mm

McPherson Suture Tying Forcep

Straight, With Tying Platform, Titanium



Catalog #	Size, Jaw Length
STI-05-1403	10 cm (4"), 5 mm

McPherson Suture Tying Forcep

Angled, With Tying Platform



Catalog #	Size, Jaw Length
STI-05-1404	10 cm (4"), 5 mm

McPherson Suture Tying Forcep

Angled, With Tying Platform, Titanium



Catalog #	Size, Jaw Length
STI-05-1405	10 cm (4"), 5 mm

Kelman-McPherson Suture Tying Forcep
 Angled, With Tying Platform

Catalog #	Size, Jaw Length
STI-05-1406	10 cm (4"), 7.5 mm

Kelman-McPherson Suture Tying Forcep
 Angled, With Tying Platform, Titanium

Catalog #	Size, Jaw Length
STI-05-1407	10 cm (4"), 7.5 mm

Kurstin Flap Stretching Forcep
 Disc Shaped, Serrated Jaws

Catalog #	Size
STI-05-1408	10.5 cm (4")

Buratto LASIK Flap Forcep
 Curved, Disc Shaped, Serrated Jaws

Catalog #	Size
STI-05-1409	10.5 cm (4")

Mendez Multipurpose LASIK Forcep
 Angled, Spatulated Jaws & Tips

Catalog #	Size
STI-05-1410	10 cm (4")



Kraff Capsule Tag Forcep
Angled



Catalog #	Size, Shank Length, Jaw Length
STI-05-1411	10.5 cm (4"), 11 mm, 1.5 mm

Utrata Capsulorhexis Forcep
Very Delicate Triangular Grasping Tips, Extremely Thin



Catalog #	Size, Shank Length
STI-05-1412	10.5 cm (4"), 11 mm

Utrata Capsulorhexis Forcep
Very Delicate Triangular Grasping Tips, Extremely Thin, Titanium



Catalog #	Size, Shank Length
STI-05-1413	10.5 cm (4"), 11 mm

Jaffe Capsulorhexis Forcep
Very Delicate Round Grasping Tips, Extremely Thin



Catalog #	Size, Shank Length
STI-05-1414	10.5 cm (4"), 11 mm

Jaffe Suture Tying Forcep
Straight, Very Delicate Smooth Jaws



Catalog #	Size, Jaw Length
STI-05-1415	10.5 cm (4"), 6 mm

Jaffe Suture Tying Forcep

Curved, Very Delicate Smooth Jaws

Catalog #	Size, Jaw Length
STI-05-1416	10.5 cm (4"), 6 mm

Tennant Suture Tying Forcep

Straight, Round Handle With Guide Pin, Extra Delicate Smooth Jaws

Catalog #	Size, Jaw Length
STI-05-1417	10.5 cm (4"), 6 mm

Tennant Suture Tying Forcep

Straight, Round Handle With Guide Pin, Extra Delicate Smooth Jaws, Titanium

Catalog #	Size, Jaw Length
STI-05-1418	10.5 cm (4"), 6 mm

Tennant Suture Tying Forcep

Curved, Round Handle With Guide Pin, Extra Delicate Smooth Jaws

Catalog #	Size, Jaw Length
STI-05-1419	10.5 cm (4"), 6 mm

Tennant Suture Tying Forcep

Curved, Round Handle With Guide Pin, Extra Delicate Smooth Jaws, Titanium

Catalog #	Size, Jaw Length
STI-05-1420	10.5 cm (4"), 6 mm



Gerl Suture Tying Forcep

Smooth Jaws, Curved Shank, Titanium



Catalog #	Size, Jaw Length
STI-05-1421	8.5 cm (3 1/4"), 6 mm

Gradle Cilia Forcep

Smooth Jaws



Catalog #	Size
STI-05-1422	10 cm (4")

Bonaccolto Conjunctival Forcep

Longitudinal Serrated Jaws With Cross Serrated Tips



Catalog #	Size, Tip Size
STI-05-1423	10.5 cm (4"), 1.2 mm
STI-05-1424	10.5 cm (4"), 1.7 mm

Moorfield Conjunctival Forcep



Catalog #	Size
STI-05-1425	10 cm (4")

Nugent Utility Forcep

Smooth Jaws



Catalog #	Size
STI-05-1426	10.5 cm (4")

Nugent Utility Forcep
 Serrated Jaws

Catalog #	Size
STI-05-1427	10.5 cm (4")

Gold Punctal Plug Forcep
 With Longitudinal Groove, Pointed Tips

Catalog #	Size
STI-05-1428	11 cm (4 1/4")

Osher Iris Forcep
 Very Fine Textured Jaws

Catalog #	Size
STI-05-1429	11 cm (4 1/4")

Foreign Body Forcep
 Straight

Catalog #	Size
STI-05-1430	8.5 cm (3 1/4")

Jaffe Utility Forcep
 Curved, Very Delicate Smooth Jaws

Catalog #	Size
STI-05-1431	11 cm (4 1/4")

Arruga Capsule Forcep



Catalog #	Size
STI-05-1432	11 cm (4 1/4")

Akahoshi Phaco PreChopper

Delicate Jaws With Sharp Tips



Catalog #	Size, Jaw Length
STI-05-1433	11 cm (4 1/4"), 4.5 mm

Ernest Nucleus Cracker

Extra Delicate Cross Action Serrated Paddle Tips



Catalog #	Size
STI-05-1434	11 cm (4 1/4")

Dodick Nucleus Cracker

Cross Action, Longitudinally Serrated Paddle Shaped Jaws



Catalog #	Size
STI-05-1435	11 cm (4 1/4")

Alfonso Nucleus Grasping Forcep

With Two Short Rows of Delicate Interlocking Teeth



Catalog #	Size
STI-05-1436	10.5 cm (4")

Rosenwasser Donor Lamella Inserting Forcep
 With Vaulted Shanks

Catalog #	Size
STI-05-1437	11 cm (4 1/4")

Dodick IOL Folding Forcep
 For Short IOLs

Catalog #	Size
STI-05-1438	11 cm (4 1/4")

Livernois IOL Folding Forcep
 Concave Jaw Surfaces, For Soft IOLs

Catalog #	Size
STI-05-1439	10.5 cm (4")

Steinert IOL Inserting Forcep
 Conically Shaped Jaws

Catalog #	Size
STI-05-1440	10 cm (4")

Livernois IOL Holding Forcep
 Straight, Highly Polished Round Jaws For Holding Soft IOLs

Catalog #	Size
STI-05-1441	10.5 cm (4")



Livernois IOL Holding Forcep

Curved, Highly Polished Round Jaws For Holding Soft IOLs



Catalog #	Size
STI-05-1442	10.5 cm (4")



Livernois-McDonald IOL Inserting Forcep

Concave Jaws



Catalog #	Size, Jaw Length
STI-05-1443	10.5 cm (4"), 5.0 mm



Faulkner Lens Holding Forcep

Round, Smooth Jaws



Catalog #	Size
STI-05-1444	10 cm (4")

Buratto IOL Inserting Forcep

Extra Delicate Highly Polished Convex Jaws, For Soft IOLs



Catalog #	Size
STI-05-1445	10 cm (4")



Bechert Lens Holding Forcep

Very Delicate Flat Jaws



Catalog #	Size
STI-05-1446	12.5 cm (5")

Forceps Instruments

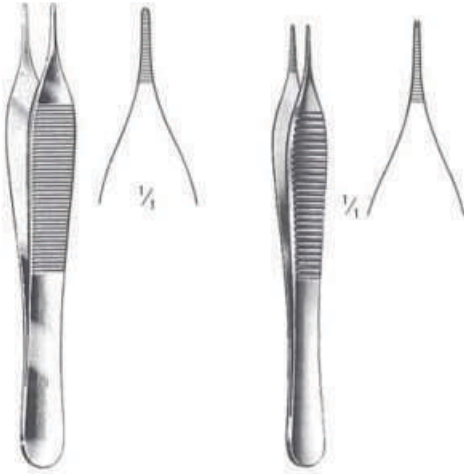

cm	ADSON	ADSON micro
12,0	STI-06-1522	STI-06-1524
12,0		
15,0	STI-06-1523	STI-06-1525
15,0		



CUSHING
STI-06-1526
17 cm

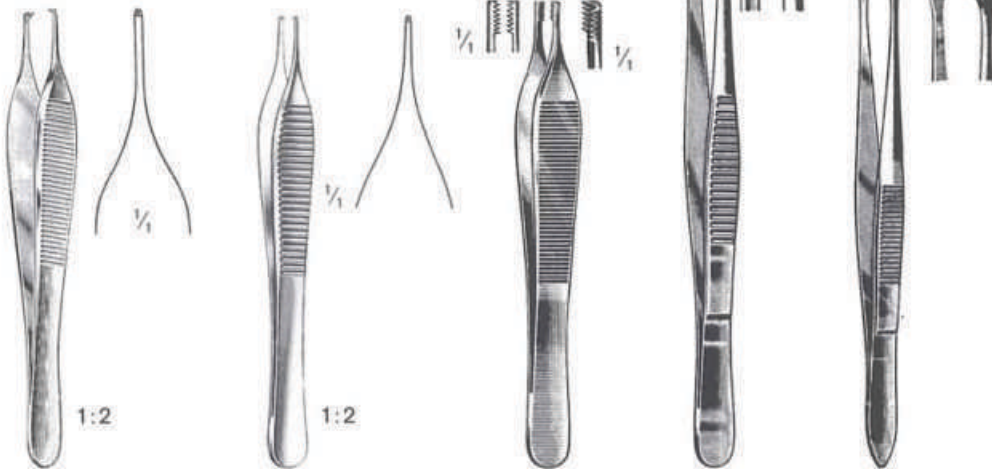

cm	ADSON	ADSON micro	ADSON-BROWN	BROWN	GRAEFE
10,5					STI-06-1536
12,0	STI-06-1527	STI-06-1529	STI-06-1531		
15,0	STI-06-1528	STI-06-1530	STI-06-1532		
16,0				STI-06-1533	
20,0				STI-06-1534	
25,0				STI-06-1535	



CUSHING
STI-06-1537
17 cm

Pinzetten
 Thumb and Tissue Forceps
 Pincés à dissection
 Pinzas de disección
 Pinze per dissezione

	5:6	4:5	1:2	2:3	1:2	2:3
cm	LERCHE	ADLERKREUTZ	LANE	LANE	FERRIS-SMITH	FERRIS-SMITH
14,5						
15,0	STI-06-1538	STI-06-1539	STI-06-1541	STI-06-1543		
18,0			STI-06-1542	STI-06-1544	STI-06-1545	STI-06-1546
20,0		STI-06-1540	STI-06-1543			

cm	DUVAL	COLLIN-DUVAL	Russ. Mod.	McINDOE
14,5	STI-06-1547			
15,0	STI-06-1548	STI-06-1551	STI-06-1552	STI-06-1553
20,0	STI-06-1549			
25,0	STI-06-1550			

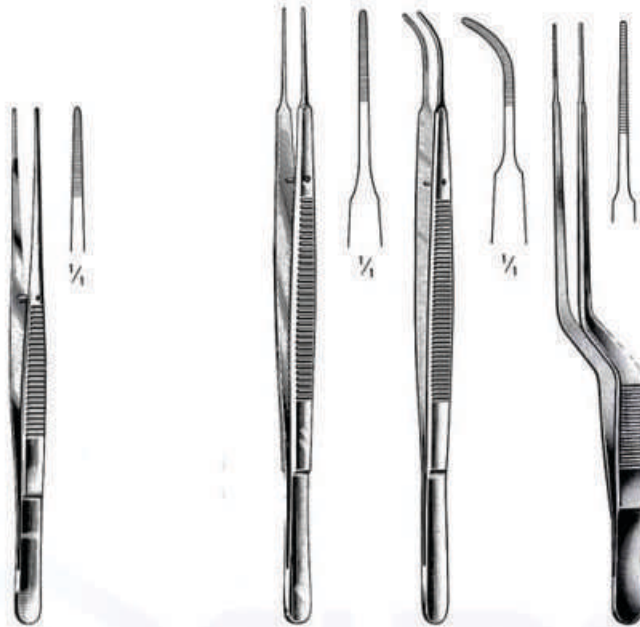

cm	SEMKEN	GERALD	GERALD	GERALD
12,5	STI-06-1554			
15,5	STI-06-1555	STI-06-1556	STI-06-1557	STI-06-1558
18,0				

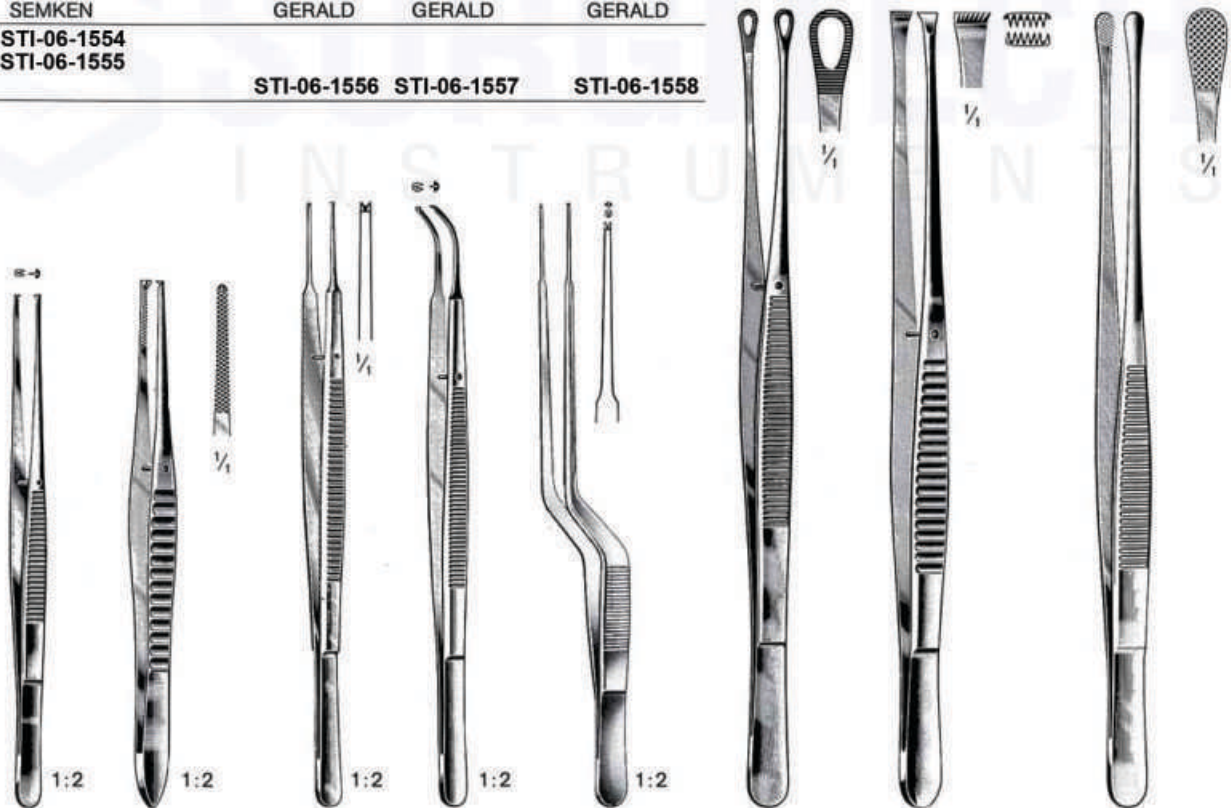

cm	SEMKEN	GILLIES	GERALD	GERALD	GERALD	SINGLEY	NELSON	WANGENSTEEN
12,5	STI-06-1559						STI-06-1568	
15,5	STI-06-1560	STI-06-1561	STI-06-1562	STI-06-1564	STI-06-1565	STI-06-1566	STI-06-1569	
18,0			STI-06-1563			STI-06-1567	STI-06-1570	
23,0								STI-06-1571

Splitterpinzetten, -zangen
 Splinter Forceps
 Pincés à échardes
 Pinzas para espinas
 Pinze per schegge

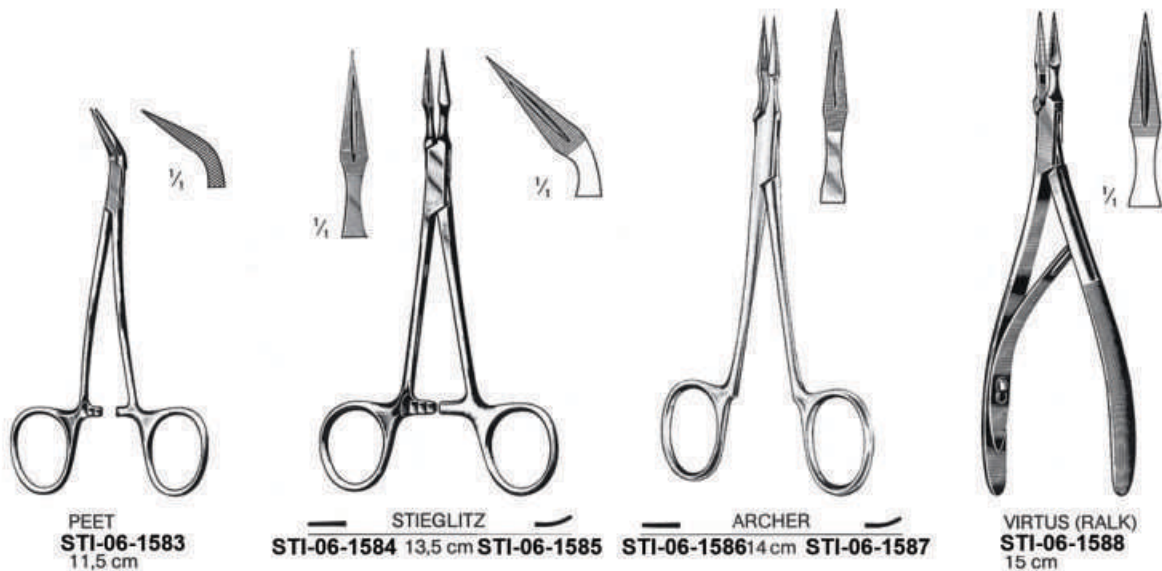



STI-06-1589

12 cm



STI-06-1590

15 cm



STI-06-1591

18 cm
23 cm

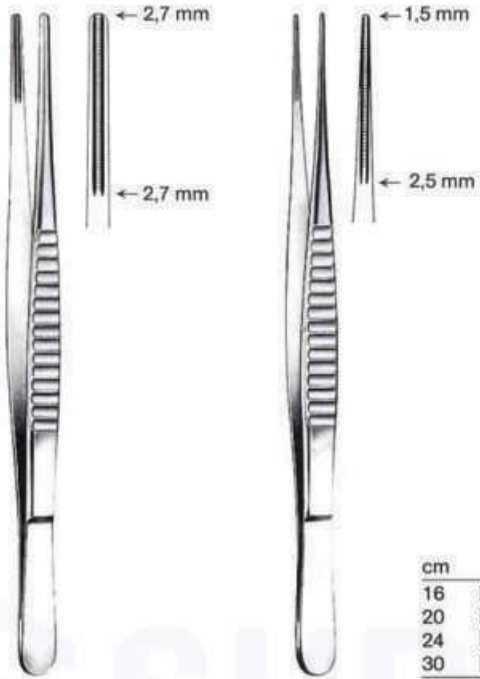

cm	DE BAKEY	DE BAKEY
16	EV-06-1592	EV-06-1596
20	EV-06-1593	EV-06-1597
24	EV-06-1594	EV-06-1598
30	EV-06-1595	



cm	DE BAKEY	DE BAKEY	DE BAKEY	COOLEY
16	STI-06-1599	STI-06-1604	STI-06-1608	STI-06-1612
20	STI-06-1601	STI-06-1605	STI-06-1609	STI-06-1613
24	STI-06-1602	STI-06-1606	STI-06-1610	STI-06-1614
30	STI-06-1603	STI-06-1607	STI-06-1611	

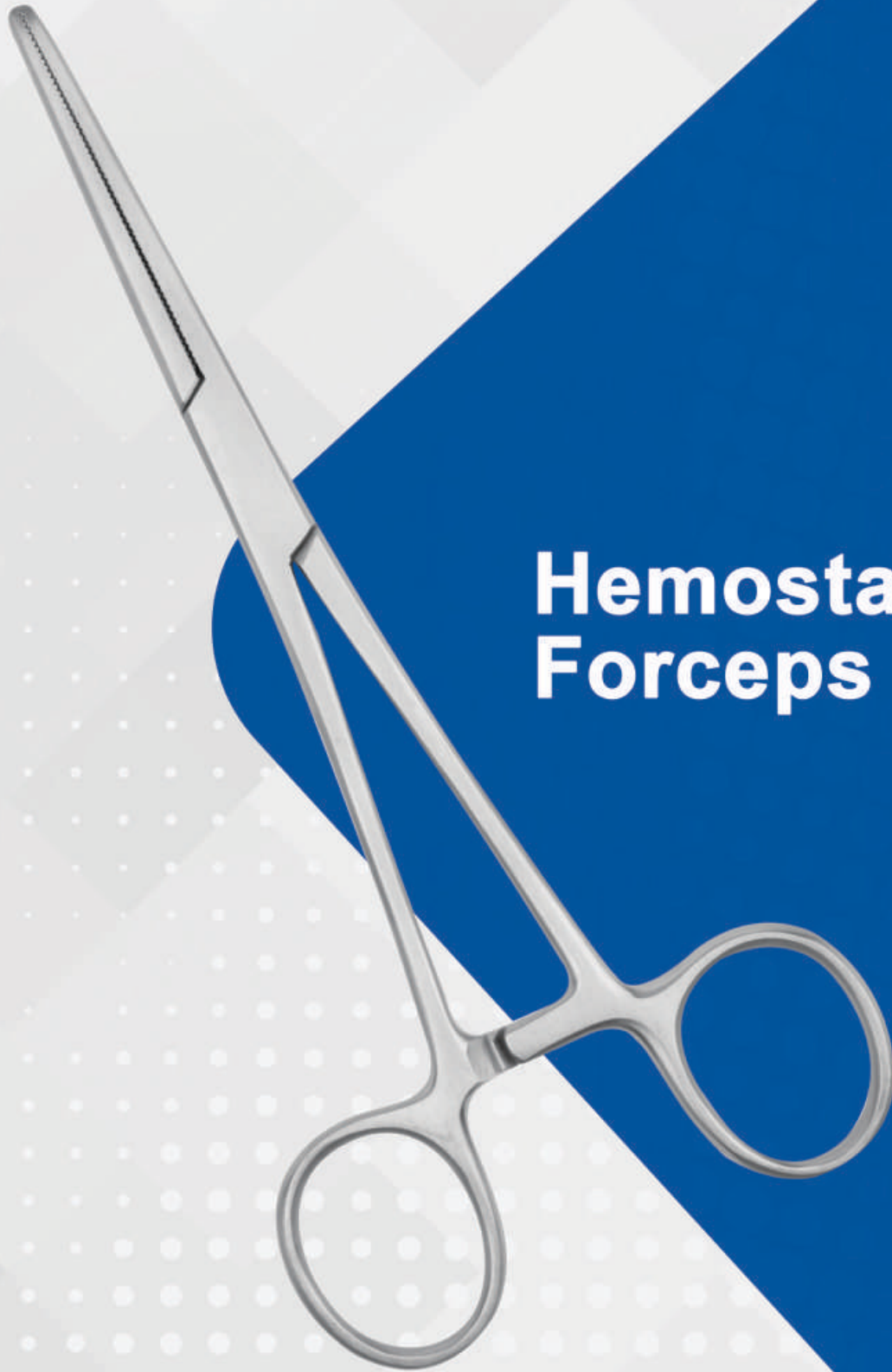

Hemostatic Forceps



DE BAKEY
STI-07-1615-1622

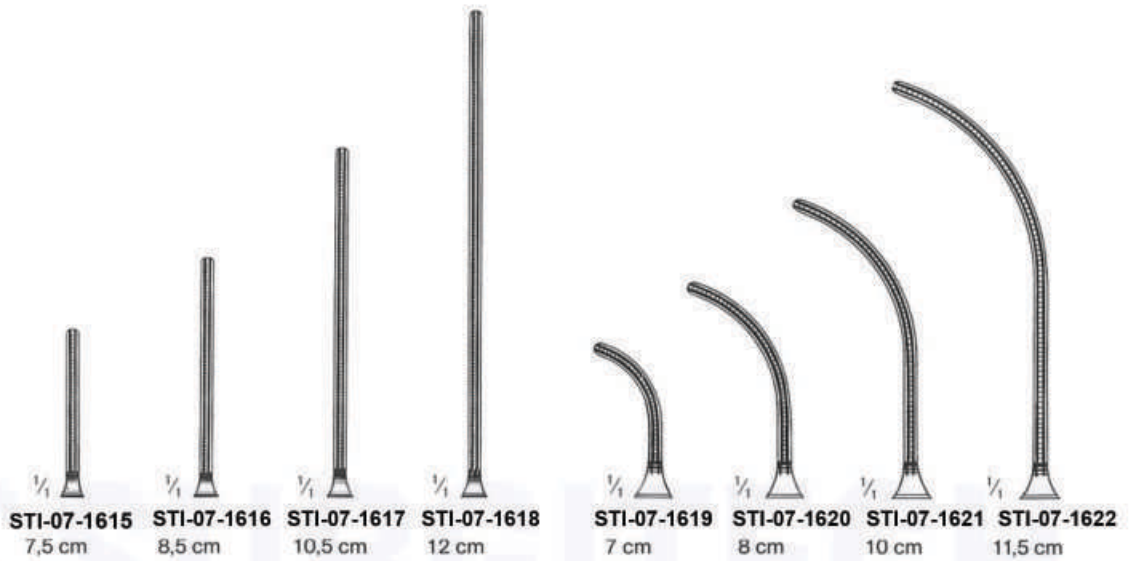

GLOVER
STI-07-1623-1630

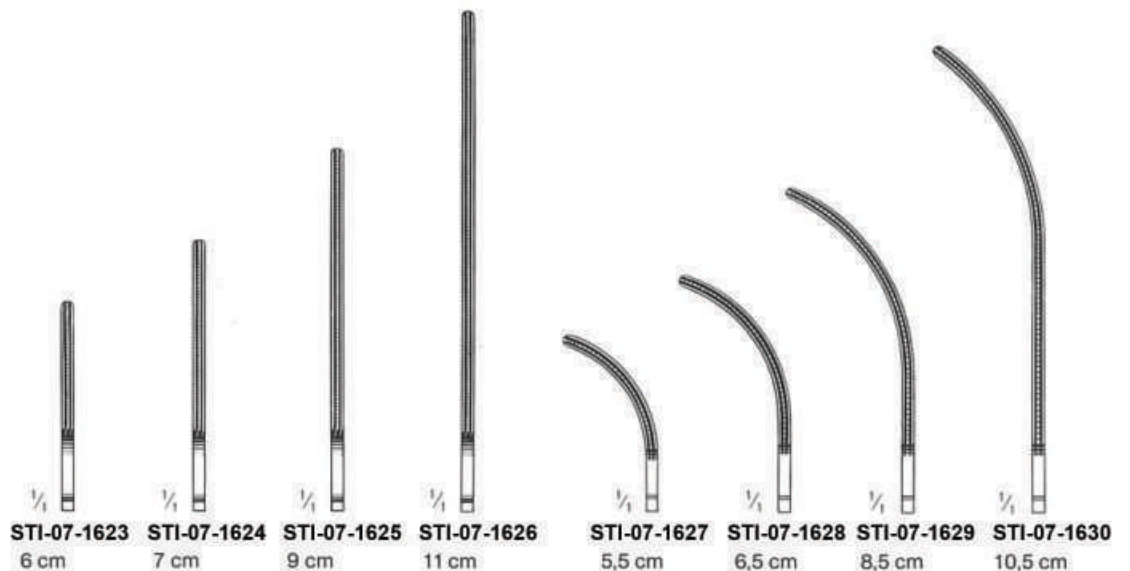

Gefäßklemmen
Serrefines
Serre-fines
Serra-finas
Serrefine



cm	DIEFFENBACH		JOHNS-HOPKINS	
3,5	STI-07-1631	STI-07-1633	STI-07-1635	STI-07-1641
5,0	STI-07-1632	STI-07-1634	STI-07-1636	STI-07-1642
5,5				
6,5			STI-07-1637	STI-07-1643
7,0			STI-07-1638	STI-07-1644
7,5			STI-07-1639	STI-07-1645
9,0			STI-07-1640	STI-07-1646

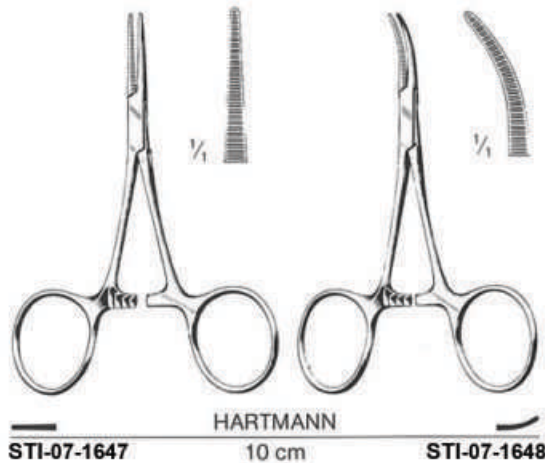

Titan
 Titanium
 Titane
 Titanio
 Titanio

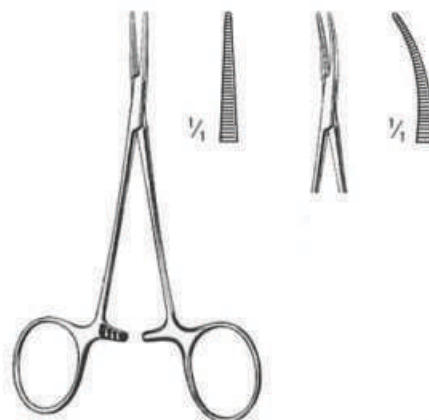

cm	— HALSTED-MOSQUITO —			— HALSTED-MOSQUITO micro —		
12,5	STI-07-1651	STI-07-1652	STI-07-1656	STI-07-1660	STI-07-1661	STI-07-1662
14,0		STI-07-1653	STI-07-1657			
18,0		STI-07-1654	STI-07-1658			
21,0		STI-07-1655	STI-07-1659			

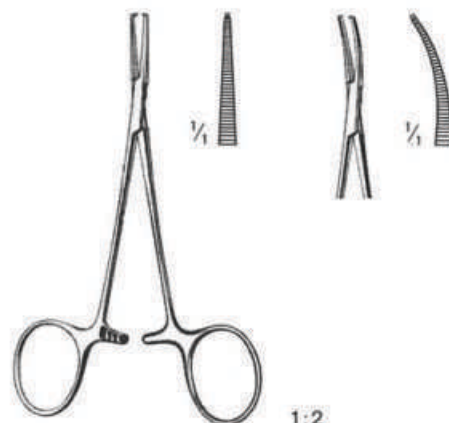

cm	— HALSTED-MOSQUITO —			— HALSTED-MOSQUITO micro —		
12,5	STI-07-1663	STI-07-1664	STI-07-1668	STI-07-1672	STI-07-1673	STI-07-1674
14,0		STI-07-1665	STI-07-1669			
18,0		STI-07-1666	STI-07-1670			
21,0		STI-07-1667	STI-07-1671			

Titan
 Titanium
 Titane
 Titanio
 Titanio

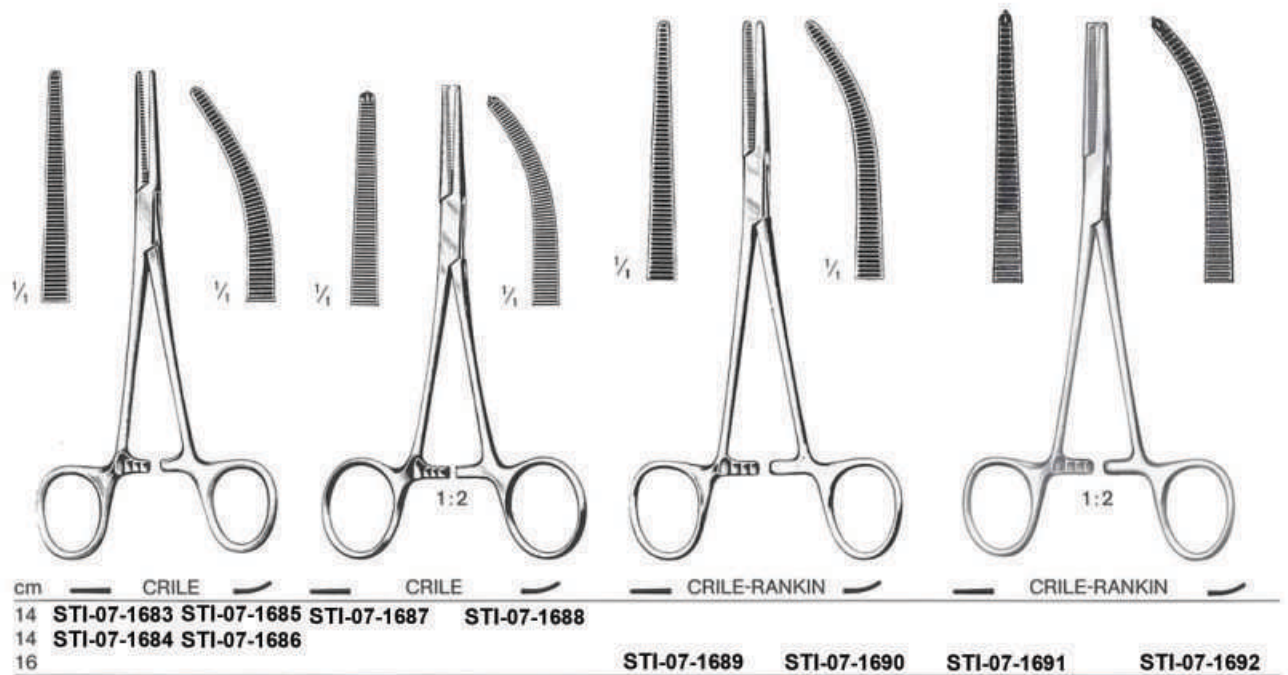
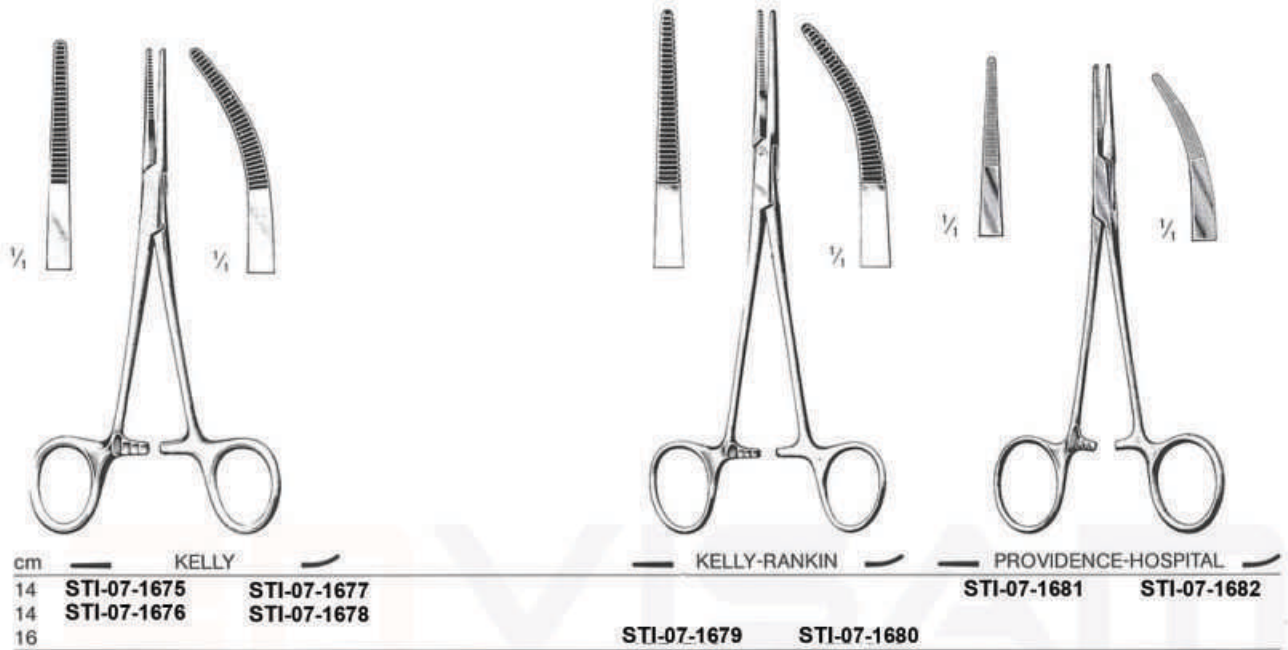

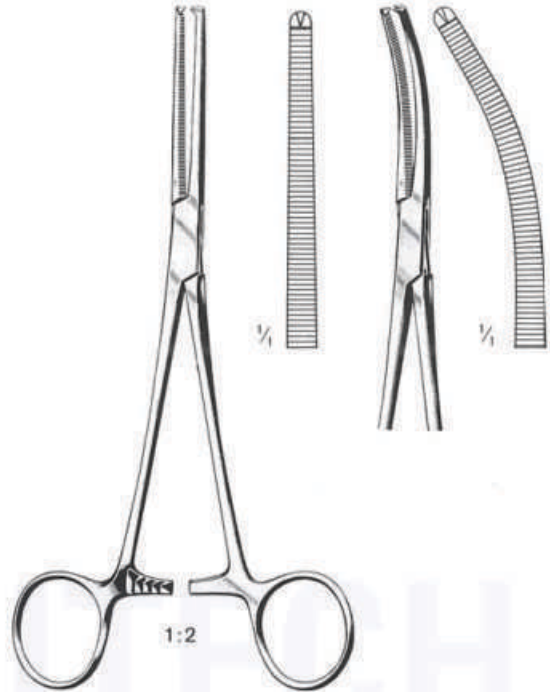
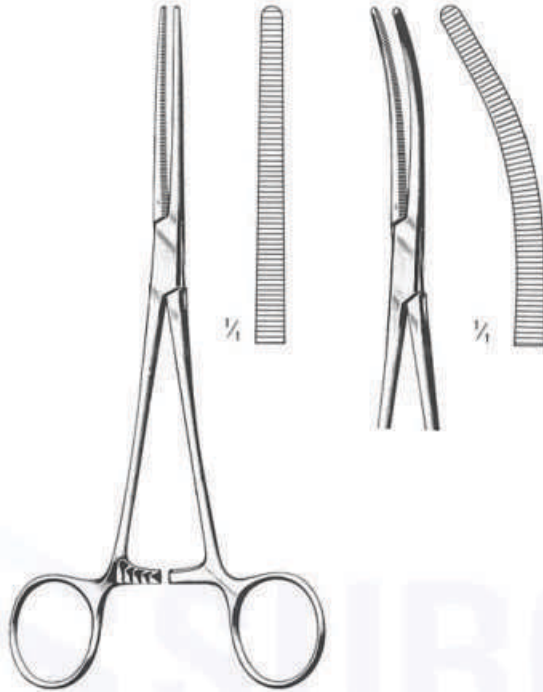

cm	ROCHESTER-PEAN	
13	STI-07-1693	STI-07-1703
14	STI-07-1694	STI-07-1704
16	STI-07-1695	STI-07-1705
18	STI-07-1696	STI-07-1706
20	STI-07-1697	STI-07-1707
22	STI-07-1698	STI-07-1708
24	STI-07-1699	STI-07-1709
26	STI-07-1701	STI-07-1710
30	STI-07-1702	STI-07-1711

ROCHESTER-OCHSNER	
STI-07-1712	STI-07-1721
STI-07-1713	STI-07-1722
STI-07-1714	STI-07-1723
STI-07-1715	STI-07-1724
STI-07-1716	STI-07-1725
STI-07-1717	STI-07-1726
STI-07-1718	STI-07-1727
STI-07-1719	STI-07-1728
STI-07-1720	STI-07-1729

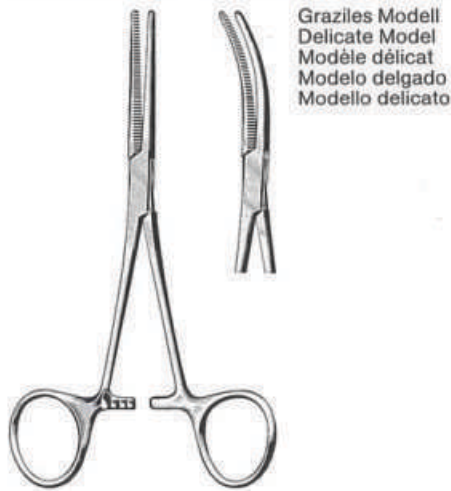

Graziles Modell
 Delicate Model
 Modèle délicat
 Modelo delgado
 Modello delicato

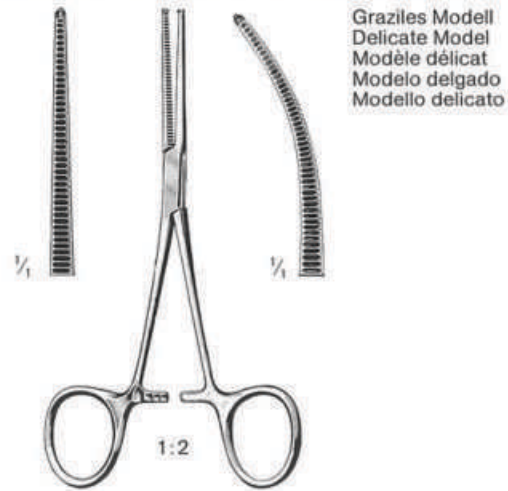

Graziles Modell
 Delicate Model
 Modèle délicat
 Modelo delgado
 Modello delicato

PEAN		
STI-07-1730	14 cm	STI-07-1732
STI-07-1731	16 cm	STI-07-1733

KOCHER		
STI-07-1734	14 cm	STI-07-1736
STI-07-1735	16 cm	STI-07-1737

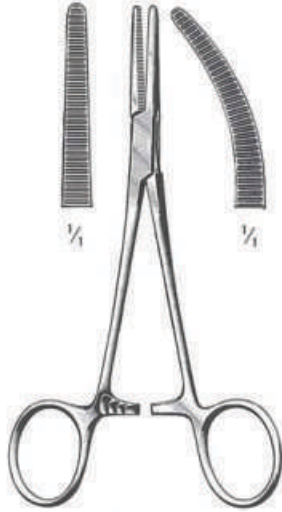

SPENCER-WELLS

STI-07-1758	13 cm	STI-07-1762
STI-07-1759	15 cm	STI-07-1763
STI-07-1760	18 cm	STI-07-1764
STI-07-1761	20 cm	STI-07-1765

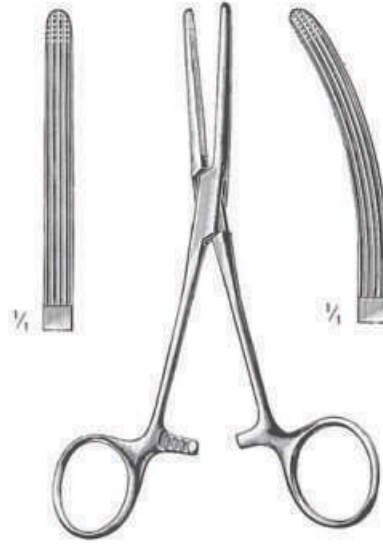

ROCHESTER-CARMALT

STI-07-1766	16 cm	STI-07-1768
STI-07-1767	20 cm	STI-07-1769

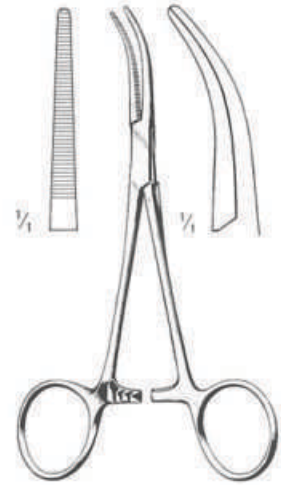

DANDY
STI-07-1770
14 cm

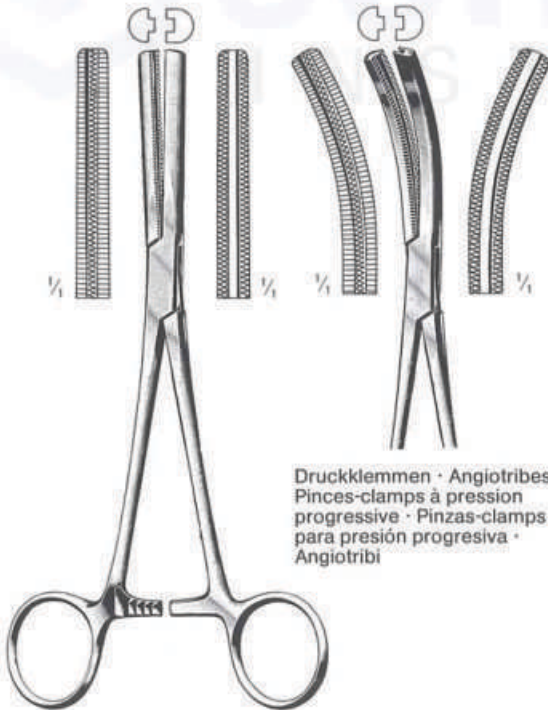

FERGUSSON

STI-07-1771	16 cm	STI-07-1773
STI-07-1772	20 cm	STI-07-1774

Druckklemmen · Angiotribes
Pincés-clamps à pression
progressive · Pinzas-clamps
para presión progresiva ·
Angiotribi

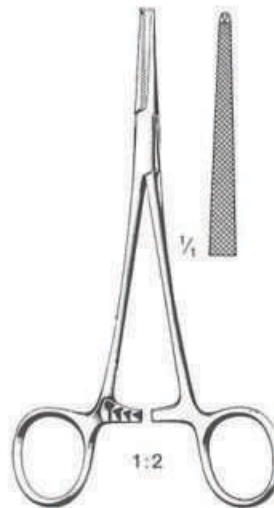

LOVELL
STI-07-1775
15,5 cm



cm	PENNINGTON
15,5	STI-07-1776
20,0	STI-07-1777





LERICHE LERICHE BENGOLEA BENGOLEA
STI-07-1787 15cm STI-07-1788 STI-07-1789 15cm STI-07-1790 STI-07-1791 20 cm STI-07-1793 STI-07-1795 20 cm STI-07-1797
STI-07-1792 26 cm STI-07-1794 STI-07-1796 26 cm STI-07-1798

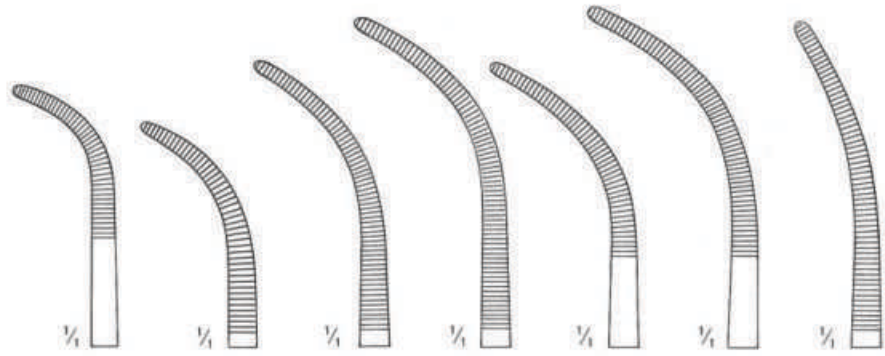

Fig. 1 2 3
STI-07-1799 STI-07-1801 STI-07-1802
HEISS 20 cm
ADSON ADSON ADSON Baby
STI-07-1803 18,5cm STI-07-1804 STI-07-1805 8,5 cm STI-07-1806 STI-07-1807



OVERHOLT-GEISSENDOERFER
 12.421.01 - 12.427.07

Präparier- und Ligaturklemmen
 Dissecting and Ligature Forceps
 Pincas à dissection et à ligatures
 Pinzas para disección y ligaduras
 Pinze per dissezione e per legature (Passafili)



cm	Fig. 1	Fig. 2	Fig. 3	Fig. 4	Fig. 5	Fig. 6	Fig. 7
21	STI-07-1808	STI-07-1810	STI-07-1812	STI-07-1814	STI-07-1816	STI-07-1818	STI-07-1820
27	STI-07-1809	STI-07-1811	STI-07-1813	STI-07-1815	STI-07-1817	STI-07-1819	STI-07-1821



GEMINI
 GEMINI mini

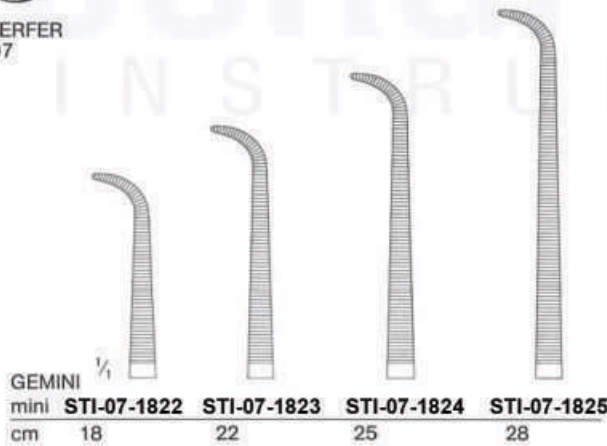

GEMINI mini	STI-07-1822	STI-07-1823	STI-07-1824	STI-07-1825
cm	18	22	25	28

GEMINI	STI-07-1826	STI-07-1827	STI-07-1828	STI-07-1829	STI-07-1830	STI-07-1831	STI-07-1832
cm	13	16	18	20	23	25	28



STI-07-1833



STI-07-1834

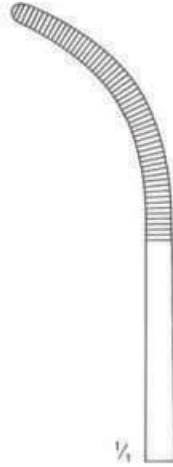

STI-07-1835



STI-07-1836



RUMEL
STI-07-1833-1836
23 cm



EV-07-1837 21 cm
EV-07-1838 26 cm



EV-07-1841 21 cm
EV-07-1842 26 cm



STI-07-1839 21 cm
STI-07-1840 26 cm



STI-07-1843 21 cm
STI-07-1844 26 cm



TOENNIS
STI-07-1837-1844
21 cm 26 cm

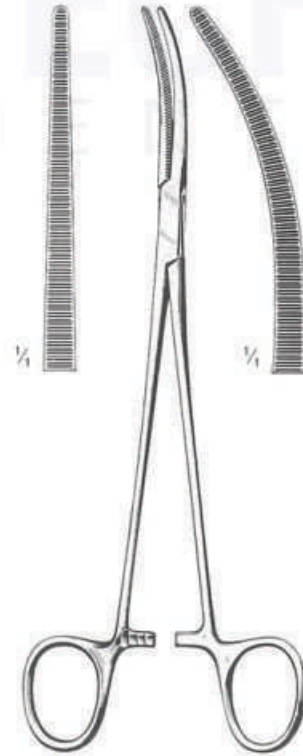

ROBERTS
STI-07-1845 22 cm STI-07-1846

Arterienklemmen
 Hemostatic Forceps
 Pincès hémostatiques
 Pinzas hemostáticas
 Pinze emostatiche

Bronchusklemmen
 Bronchus Forceps
 Pincès-Clamps à Bronches
 Pinzas clamps bronquiales
 Pinze per bronchi

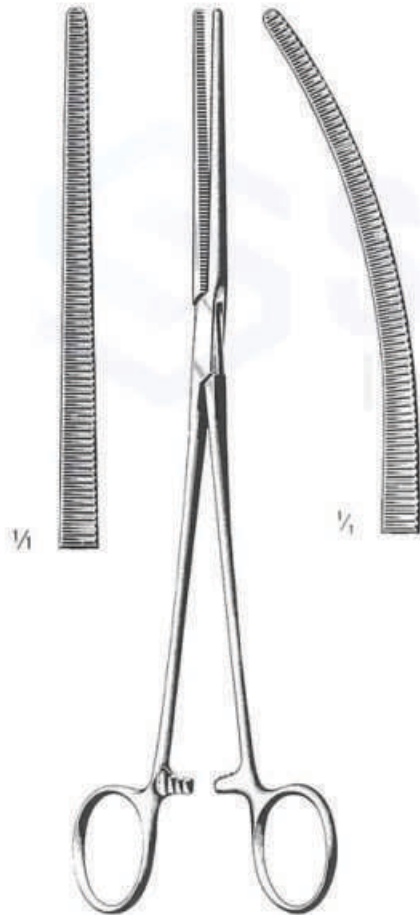

SAROT
 STI-07-1847 24 cm STI-07-1848



CRAFOORD
 STI-07-1849
 24 cm

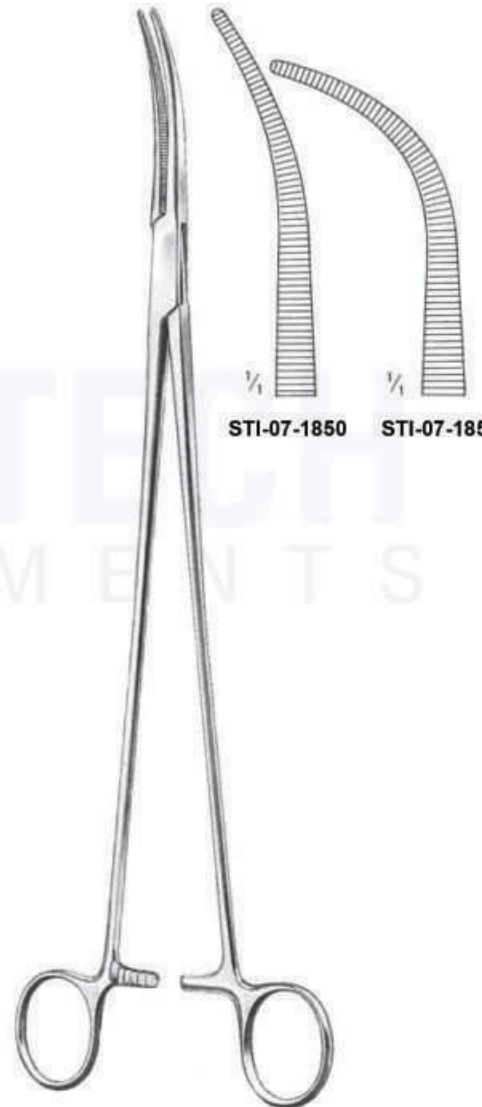

ZENKER
 STI-07-1850-1851
 29,5 cm



LAWRENCE
STI-07-1852
28 cm

MEEKER
STI-07-1853
28 cm

cm	MIXTER
14	STI-07-1854
16	STI-07-1855
18	STI-07-1856
23	STI-07-1857

MIXTER
STI-07-1858
22 cm

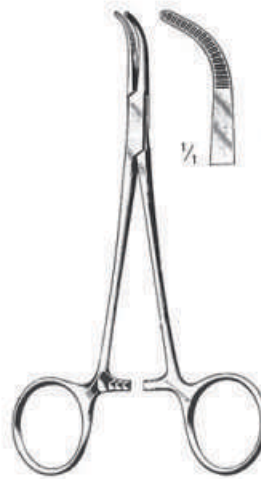

MIXTER Baby
STI-07-1859
14 cm



MIXTER Baby
STI-07-1860
18 cm

Arterien, Gallenkanal, Nierenstiel
 Hemostatic, Gall Duct, and Kidney Pedicle
 Hémostatiques, pédicule rénal et voies biliaires
 Hemostáticas, pedículo renal y vías biliares
 Emostatiche, pedunculo renale e vie biliari

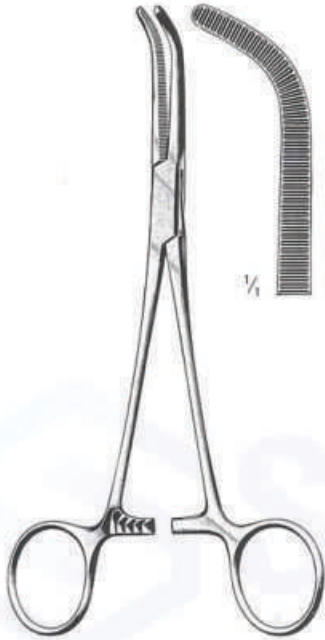

cm	MIXTER-O'SHAUGNESSY
15,5	STI-07-1861
19,0	STI-07-1862



STI-07-1863	STI-07-1864	STI-07-1865
22 cm	25 cm	28 cm

MIXTER
 STI-07-1863-1865

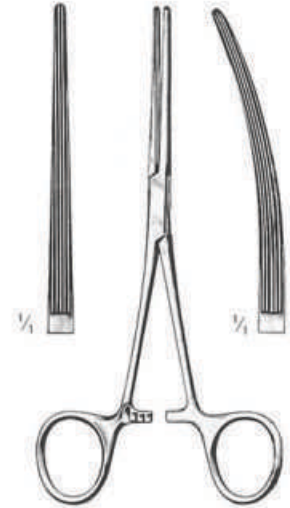

BAINBRIDGE			
STI-07-1866	15,0 cm	STI-07-1868	
STI-07-1867	18,5 cm	STI-07-1869	

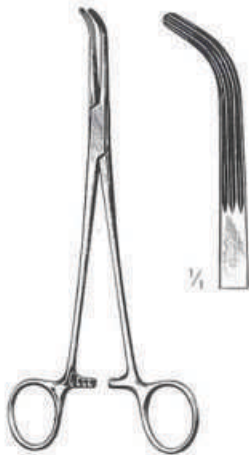

LAHEY
 STI-07-1870
 19 cm

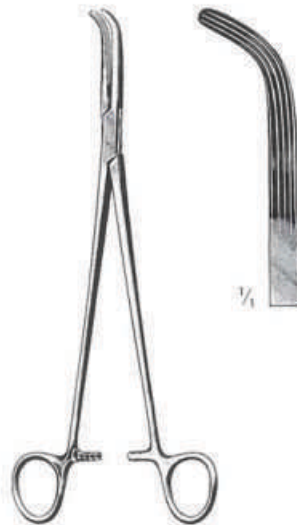

LAHEY
 STI-07-1871
 23 cm



LOWER
 STI-07-1872
 18 cm

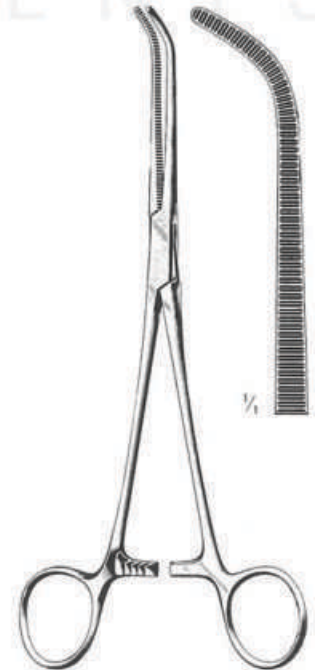

JOHNS-HOPKINS
 STI-07-1873
 20 cm



STILLE
STI-07-1882
 23 cm

Nierenstiel, Gallenkanal
 Kidney Pedicle, Gall Duct
 Pédicule rénal, conduit biliaire
 Pediculo renal, vías biliares
 Pedunculo renale, vie biliari

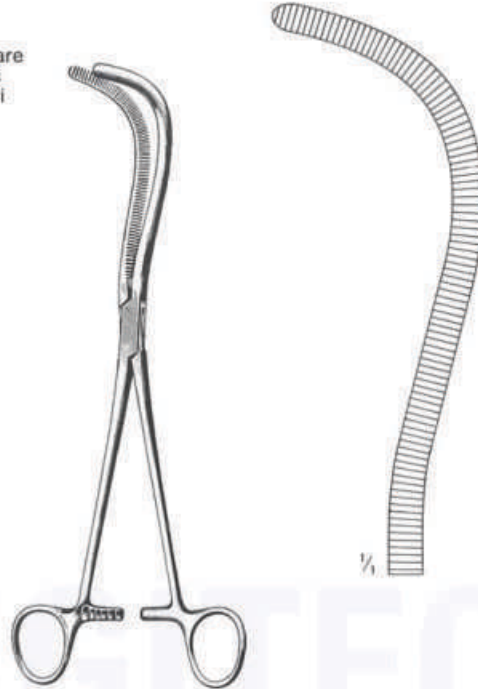

MAYO-GUYON
STI-07-1883
 23 cm

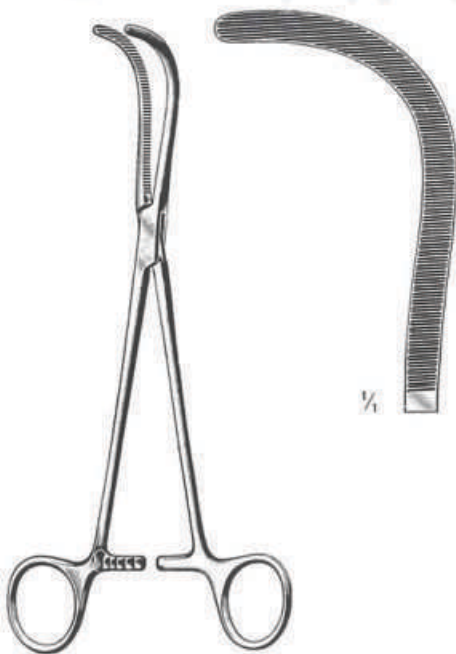

GUYON
STI-07-1884
 23 cm



GUYON

STI-07-1885
 20 cm

STI-07-1886
 22 cm

STI-07-1887
 24 cm

Nierenstiel
 Kidney Pedicle
 Pédicule rénal
 Pediculo renal
 Pedunculo renale

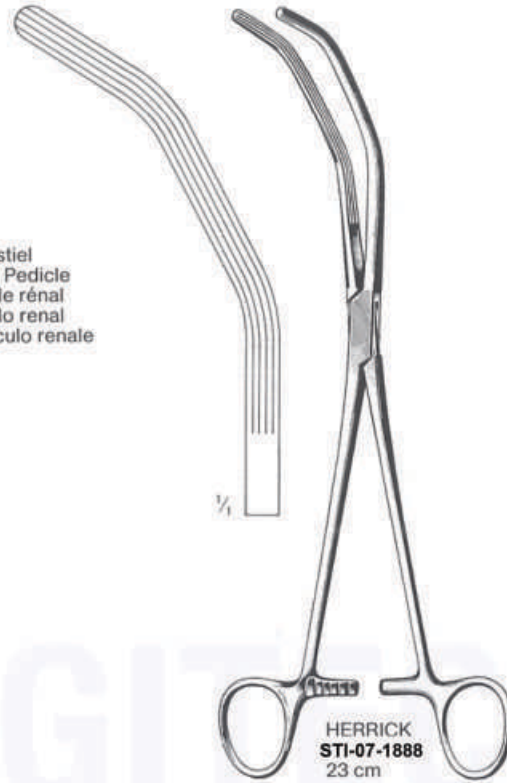

Peritoneum-Klemmen
 Peritoneum Forceps
 Pincas à péritoine
 Pinzas para peritoneo
 Pinze peritoneali



MIKULICZ
 STI-07-1889
 20 cm

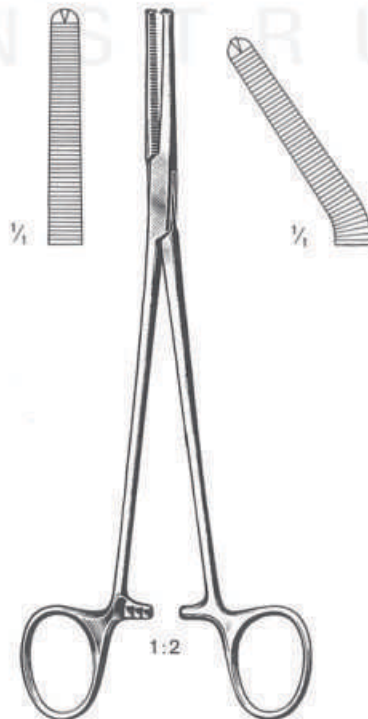

PHANEUF
 STI-07-1890 21 cm STI-07-1891

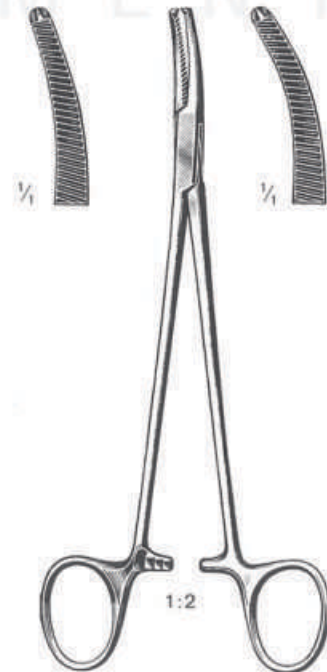

FAURE
 STI-07-1892 20 cm STI-07-1893



WERTHEIM
STI-07-1894
25 cm



WERTHEIM
STI-07-1895 22 cm STI-07-1896 23 cm



WERTHEIM-CULLEN
STI-07-1897
21,5 cm



HEANEY
21,5 cm STI-07-1898 STI-07-1899

Nierenstiel
 Kidney Pedicle
 Pédicule rénal
 Pediculo renal
 Pedunculo renale

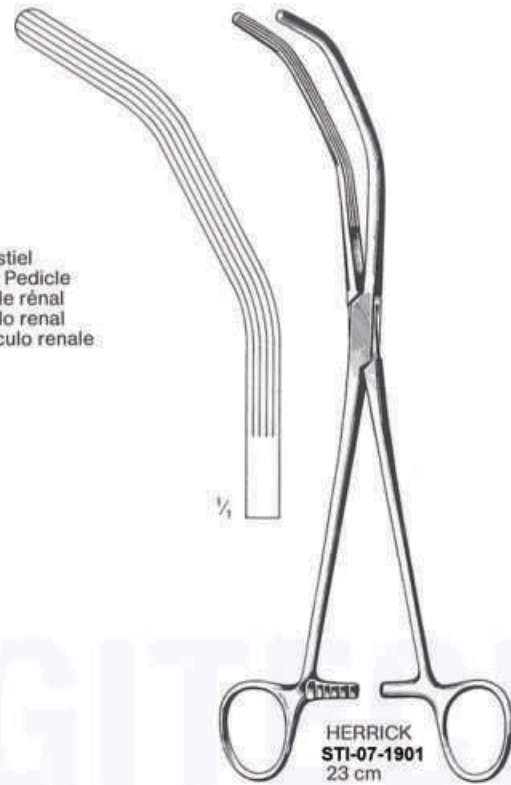

Peritoneum-Klemmen
 Peritoneum Forceps
 Pinces à péritoine
 Pinzas para peritoneo
 Pinze peritoneali



MIKULICZ
STI-07-1902
 20 cm

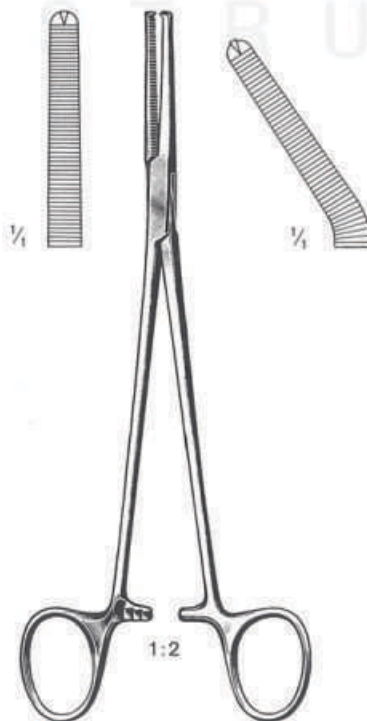

PHANEUF
STI-07-1903 21 cm **STI-07-1904**

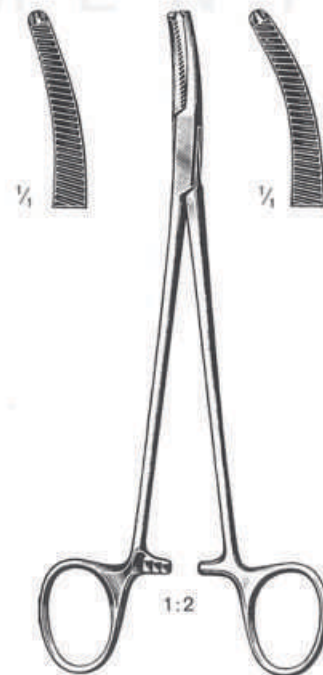

FAURE
STI-07-1905 20 cm **STI-07-1906**

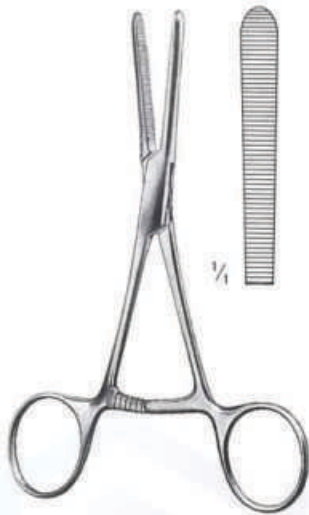

WEISS
STI-07-1907
14,5 cm

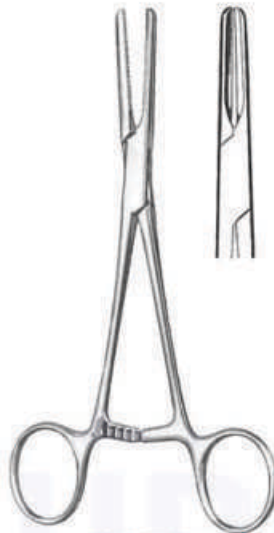

MURPHY
STI-07-1908-1910



STI-07-1908
15 cm



STI-07-1909
18 cm



STI-07-1910
20 cm

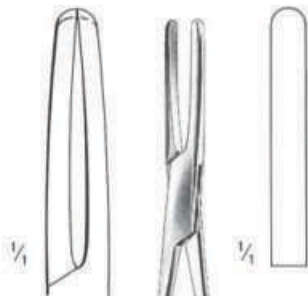

PRESBYTERIAN HOSPITAL
STI-07-1911 16 cm
STI-07-1912 18 cm

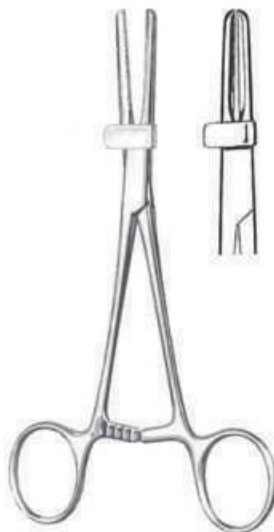

STI-07-1913-1915



STI-07-1913
15 cm



STI-07-1914
18 cm



STI-07-1915
20 cm

Atraumatic Forceps





cm — HALSTEAD-MOSQUITO —
 12,0 STI-08-1916 STI-08-1918
 15,0 STI-08-1917 STI-08-1919



cm — PEAN —
 14,0 STI-08-1920 STI-08-1924
 16,0 STI-08-1921 STI-08-1925
 18,0 STI-08-1922 STI-08-1926
 20,0 STI-08-1923 STI-08-1927



cm — RANKIN —
 16,0 STI-08-1928 STI-08-1929



cm — DE BAKEY —
 12,0 STI-08-1930 STI-08-1931



DE BAKEY
 STI-08-1932
 12,0 cm



DE BAKEY
 STI-08-1933
 12,0 cm



DE BAKEY
 STI-08-1934
 12,0 cm



cm	LEES
23,0	STI-08-1935
25,0	STI-08-1936

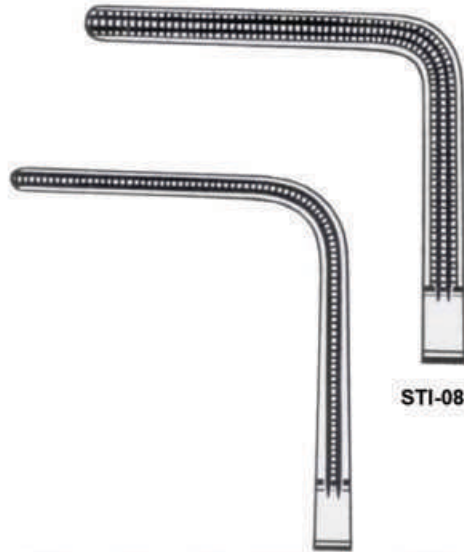

STI-08-1938

STI-08-1937

Bronchusklemmen
Bronchus Forceps
Pinces-Clamps à Bronches
Pinzas clamps bronquiales
Pinze per bronchi



LEES
STI-08-1939
25,0 cm

Coarctationsklemmen
 Coarction Clamps
 Pincés à coarctacion
 Pinzas para coarctación
 Pinze per coartazione



cm	POTTS
20,0	STI-08-1940
22,5	STI-08-1941
26,0	STI-08-1942

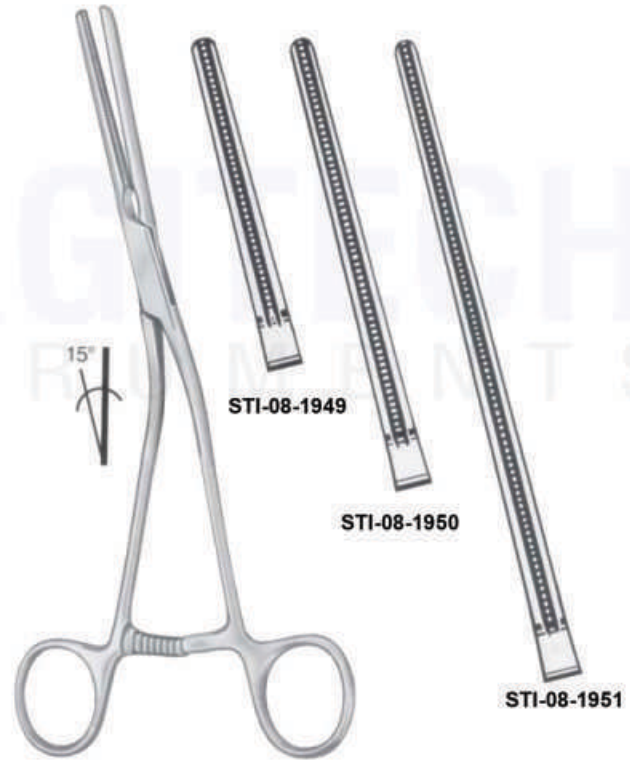

cm	GLOVER
20,0	STI-08-1946
22,5	STI-08-1947
26,0	STI-08-1948

Anastomosenklemmen
Anastomosis Clamps
Pincès à anastomose
Pinzas para anastomosis
Pinze per anastomosi



cm POTT'S / GLOVER
21,0 STI-08-1952
24,0 STI-08-1953



STI-08-1954

STI-08-1955



cm GLOVER
18,0 STI-08-1956
22,0 STI-08-1957



STI-08-1958

STI-08-1959

Vascularklemme löffelförmig
 Vascular Clamps Spoon Shaped
 Pince vasculaire forme cuiller
 Pinza vascular forma cuchara
 Pinza vascolare forma cucchiaio



cm GLOVER
 21,0 STI-08-1960
 26,0 STI-08-1961

Peripher-Vascularklemmen
 Peripheral Vascular Forceps
 Pincés vasculaires périph.
 Pinzas vasculares perif.
 Pinze vascolari perif.

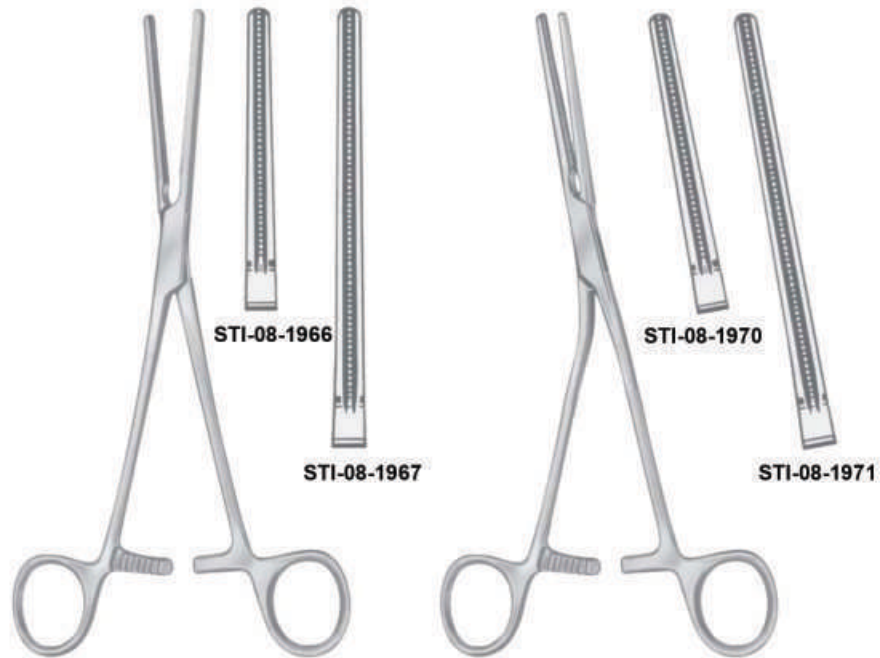

cm DE BAKEY
 18,0 STI-08-1964
 22,0 STI-08-1965

cm DE BAKEY
 18,0 STI-08-1968
 22,0 STI-08-1969

Atraumatische Mehrzweckklemmen
Atraumatic Multi-Purpose Clamps
Pincès-clamps polyvalentes
Pinzas clamps para usos varios
Pinze atraumatiche per diversi usi



DARDIK

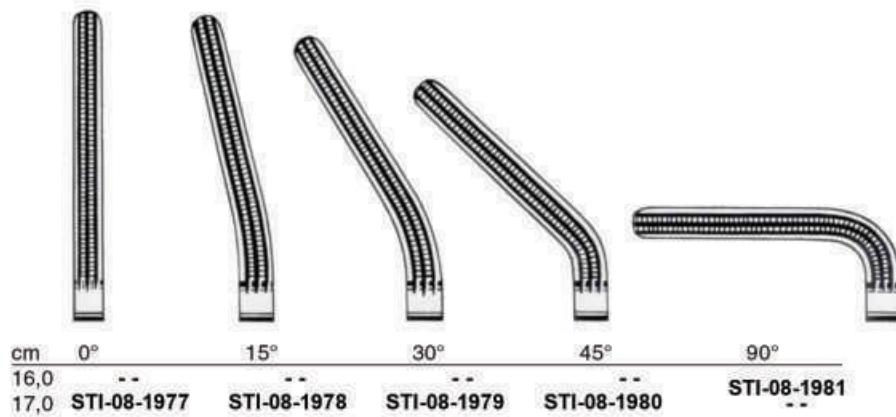
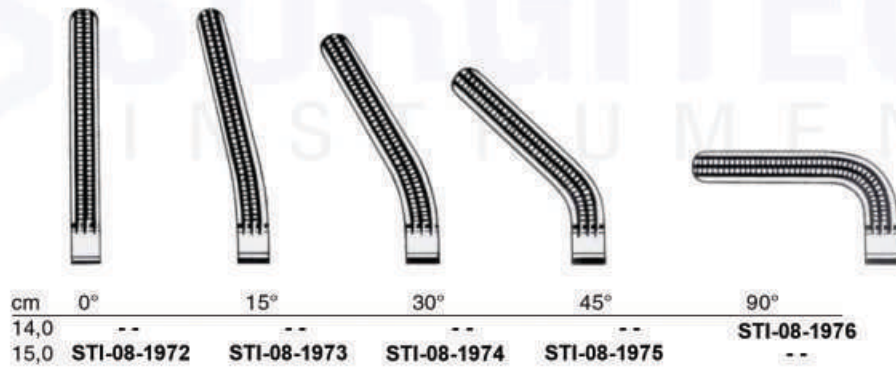

Aortaklemmen
Aortic Clamp
Pince-clamp à aorte
Pinza clamp para aorta
Pinza per aorta



LIDDLE
STI-08-1982
27,0 cm



Aorta-Anastomosenklemmen
Aorta-Anastomosis Clamps
Pinces-clamps pour anastomoses d'aorte
Pinzas clamps para anastomosis de aorta
Pinze aortiche



LAMBERT KAY
STI-08-1983
20,0 cm



BAINBRIDGE



STI-08-1984
15,0 cm



STI-08-1985
18,0 cm



STI-08-1986
15,0 cm



STI-08-1987
18,0 cm



LELAND JONES
STI-08-1988
19,0 cm



Peripher-Vascularklemmen
 Peripheral Vascular Forceps
 Pinces vasculaires périph.
 Pinzas vasculares perif.
 Pinze vascolari perif.



LELAND JONES



STI-08-1989
19,0 cm



STI-08-1990
19,0 cm

Aortaklemmen
Aortic Clamp
Pince-clamp à aorte
Pinza clamp para aorta
Pinza per aorta



LIDDLE
STI-08-1991
27,0 cm



Aorta-Anastomosenklemmen
Aorta-Anastomosis Clamps
Pinces-clamps pour anastomoses d'aorte
Pinzas clamps para anastomosis de aorta
Pinze aortiche



LAMBERT KAY
STI-08-1992
20,0 cm

Iliaca-Klemme
 Iliac Clamp
 Pince-clamp à iliaque
 Pinza clamp para iliaca
 Pinza per iliaca

LAMBERT KAY
STI-08-1993
 20,0 cm

DE BAKEY
STI-08-1994
 20,0 cm



WEBER
STI-08-1995
26,0 cm



WEBER
STI-08-1996
26,0 cm

Aorta-Aneurysma-Klemmen
Aorta-Aneurysm Clamps
Pincés-clamps pour aneurysme d'aorte
Pinzas clamps para aneurisma de aorta
Pinze per aneurisma di aorta



DE BAKEY



STI-08-1997

24,0 cm

STI-08-1998

27,0 cm

STI-08-1999

31,0 cm

STI-08-2001

35,0 cm

Aorta-Aneurysma-Klemmen
 Aorta-Aneurysm Clamps
 Pincès-clamps pour aneurysme d'aorte
 Pinzas clamps para aneurisma de aorta
 Pinze per aneurisma di aorta



DE BAKKEY BAHNSON



STI-08-2002
24,0 cm

STI-08-2002
25,0 cm

STI-08-2003
26,0 cm

Aorta-Aneurysma-Klemmen
Aorta-Aneurysm Clamps
Pinces-clamps pour aneurysme d'aorte
Pinzas clamps para aneurisma de aorta
Pinze per aneurisma di aorta



DE BAKEY
STI-08-2004
28,0 cm

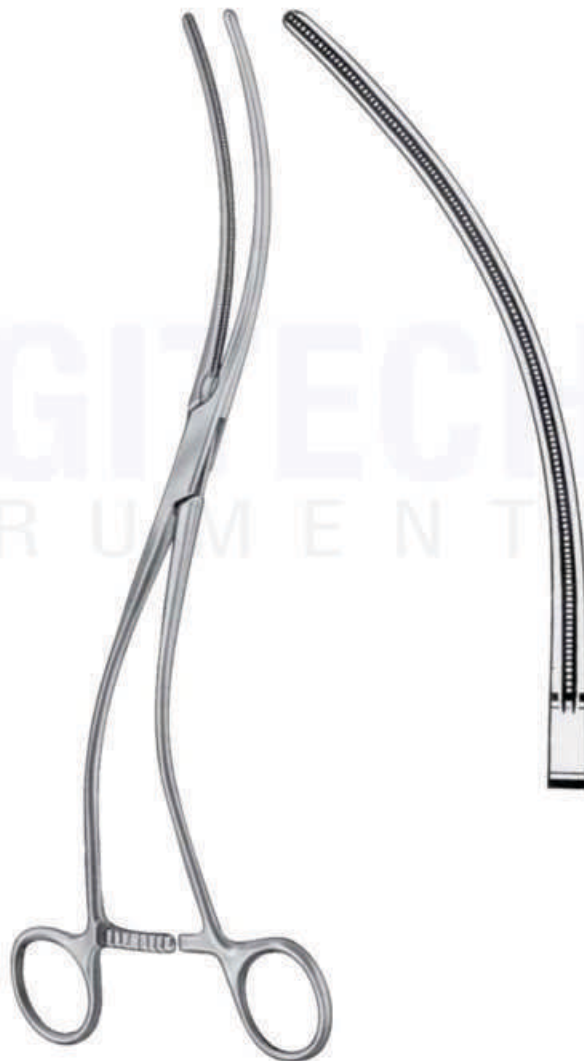

DE BAKEY
STI-08-2005
28,0 cm

Atraumatiche Mehrzweckklemmen
 Atraumatic Multi-Purpose Clamps
 Pinces-clamps polyvalentes
 Pinzas clamps para usos varios
 Pinze atraumatiche per diversi usi

DE BAKHEY MORRIS

STI-08-2006
 18,0 cm

STI-08-2007
 20,0 cm

STI-08-2008
 23,0 cm

STI-08-2009
 25,0 cm

Atraumatische Gefäßklemmen
Atraumatic Hemostatic Forceps
Pincas hémostatiques atraumatiques
Pinzas hemostáticas atraumáticas
Pinze emostatiche atraumatiche

Atraumatische Mehrzweckklemmen
Atraumatic Multi-Purpose Clamps
Pincas-clamps polyvalentes
Pinzas clamps para usos varios
Pinze atraumatiche per diversi usi



DE BAKEY



STI-08-2010
18,0 cm



STI-08-2011
21,0 cm

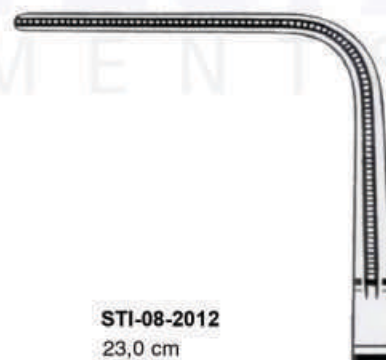

STI-08-2012
23,0 cm



STI-08-2013
27,0 cm

Aorta-Aneurysma-Klemmen
Aorta-Aneurysm Clamps
Pincés-clamps pour aneurysme d'aorte
Pinzas clamps para aneurisma de aorta
Pinze per aneurisma di aorta

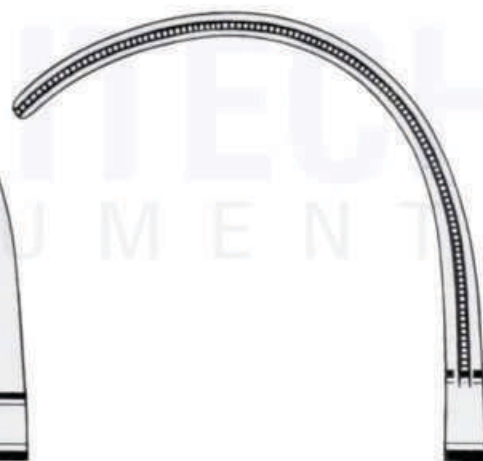

DE BAKEY

STI-08-2014
25,0 cmSTI-08-2015
26,0 cm

Bronchus-Klemmen
Bronchus Clamps
Pincés pour les bronches
Pinzas bronquiales
Pinze per bronchi

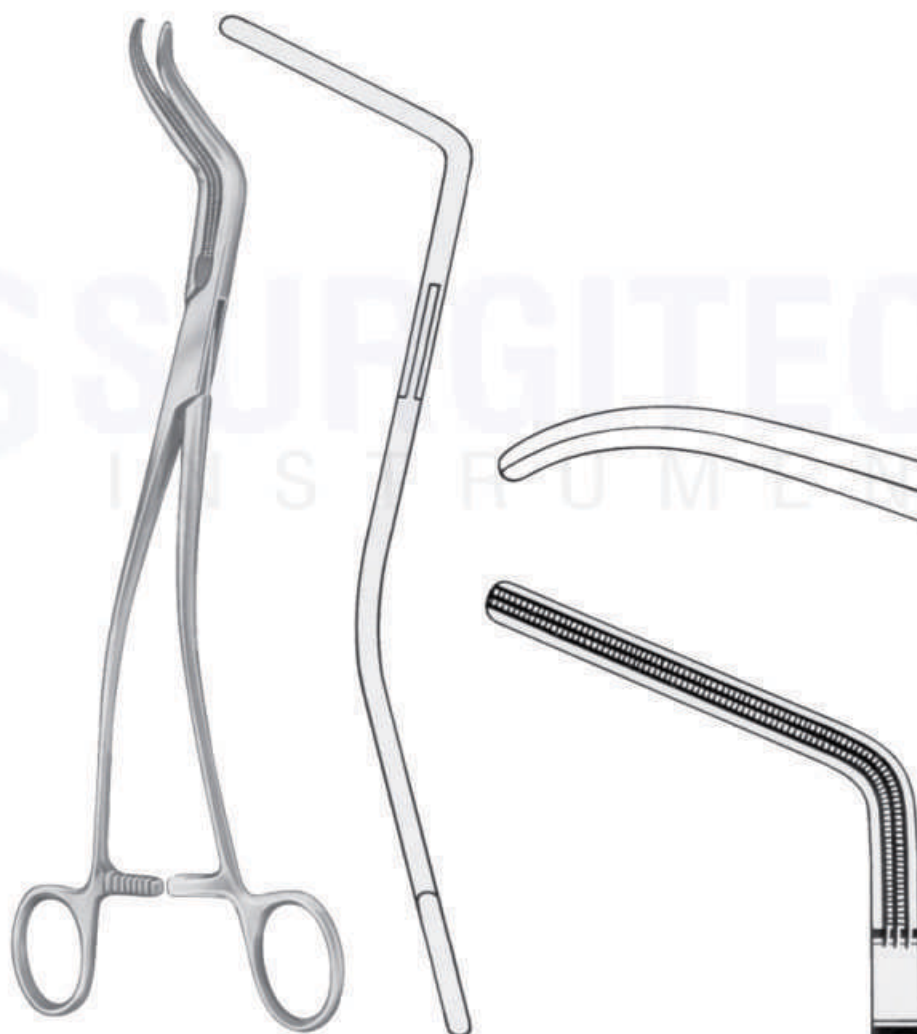

DE BAKEY
STI-08-2016
27,0 cm



DE BAKEY

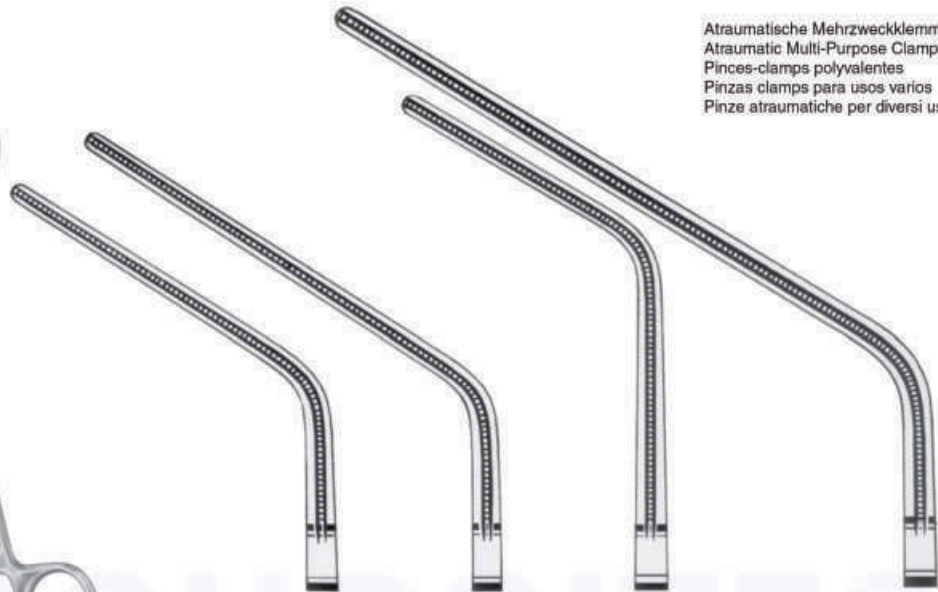

STI-08-2017
20,0 cm

STI-08-2018
24,0 cm

STI-08-2019
25,0 cm

STI-08-2020
30,0 cm

Atraumatische Mehrzweckklemmen
Atraumatic Multi-Purpose Clamps
Pincés-clamps polyvalentes
Pinzas clamps para usos varios
Pinze atraumatiche per diversi usi



SATINSKY



STI-08-2021
20,0 cm

STI-08-2022
24,0 cm

STI-08-2023
25,0 cm

STI-08-2024
26,0 cm

STI-08-2025
27,0 cm

Anlegezange für Clips
 Applying for Clips
 Appicateur pour clips
 Pinza para aplicar clips
 Applicatore per clips



EDWARDS
 STI-08-2026

Clips
 Clips
 Clips
 Clips
 Clips



mm	EDWARDS
6	STI-08-2027
12	STI-08-2028



WYLIE



STI-08-2029
 Fig. 1
 21,0 cm



STI-08-2030
 Fig. 2
 22,0 cm



DE BAKEY SATINSKY

**STI-08-2031**
Fig. 1
23,0 cm**STI-08-2032**
Fig. 2
24,0 cm**STI-08-2033**
Fig. 3
25,0 cm

Aurikelklemmen
Auricle Clamps
Pinces auriculaires
Pinzas para aurícula
Pinze ventricolari



HARKEN



STI-08-2034
Fig. 1
25,0 cm



STI-08-2035
Fig. 2
24,0 cm



STI-08-2036
Fig. 3
24,0 cm

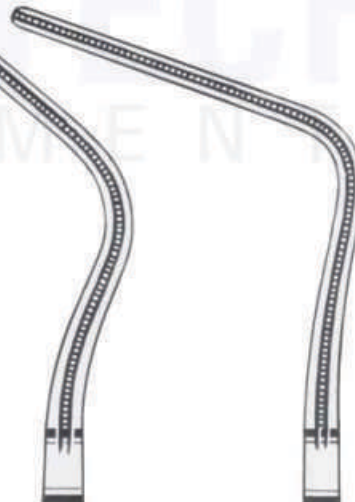

STI-08-2037
Fig. 4
24,0 cm

Peripheal-Gefäßklemmen
Peripheal Vascular Clamps
Pincés-clamps, vasculaires périphériques
Pinzas para vasos periféricos
Pinze vascolari periferali



DALE
STI-08-2038
18,0 cm



DALE

STI-08-2039
17,0 cm



STI-08-2040
18,0 cm



STI-08-2041
19,0 cm





DE BAKEY
STI-08-2042
 17,0 cm



BECK
STI-08-2043
 17,0 cm

Präparier- und Ligaturklemmen
 Dissecting and Ligature Clamps
 Pincas à dissection et passe-fil
 Pinzas de disección y para ligaduras
 Pinze per dissezione e per legature



DE BAKEY
STI-08-2044
 24,0 cm



DE BAKEY
STI-08-2045
 24,0 cm

Atraumatische Mehrzweckklemmen
 Atraumatic Multi-Purpose Clamps
 Pincès-clamps polyvalentes
 Pinzas clamps para usos varios
 Pinze atraumatiche per diversi usi



POTTS

STI-08-2046
 21,0 cm

STI-08-2047
 23,0 cm

STI-08-2048
 27,0 cm

STI-08-2049
 31,0 cm

Atraumatische Mehrzweckklemmen
Atraumatic Multi-Purpose Clamps
Pincés-clamps polyvalentes
Pinzas clamps para usos varios
Pinze atraumatiche per diversi usi



POTTS



STI-08-2050
21,0 cm



STI-08-2051
23,0 cm



STI-08-2052
27,0 cm



STI-08-2053
31,0 cm

Anastomosenklemmen, Kindergrößen
 Anastomosis Clamps, Pediatric
 Pincès à anastomose, pédiatriques
 Pinzas para anastomosis, pediátricas
 Pinze per anastomosi, pediatriche

DERRA

STI-08-2054
 16,0 cm

STI-08-2055
 17,0 cm

STI-08-2056
 18,0 cm

 Atraumatische Mehrzweckklemmen
 Atraumatic Multi-Purpose Clamps
 Pincès-clamps polyvalentes
 Pinzas clamps para usos varios
 Pinze atraumatiche per diversi usi

DE BAKEY
STI-08-2057
 16,0 cm

DE BAKEY
STI-08-2058
 17,0 cm



DE BAKY
STI-08-2059
15,0 cm



DE BAKY
STI-08-2060
17,0 cm



STI-08-2061
17,0 cm



STI-08-2062
16,0 cm

DE BAKY

Atraumatische Mehrzweckklemmen
Atraumatic Multi-Purpose Clamps
Pincès-clamps polyvalentes
Pinzas clamps para usos varios
Pinze atraumatiche per diversi usi



DE BAKEY



STI-08-2063
14,0 cm



STI-08-2064
15,0 cm



STI-08-2065
16,0 cm



GLOVER
STI-08-2066
17,0 cm

Anastomosenklemmen
Anastomosis Clamps
Pincès à anastomose
Pinzas para anastomosis
Pinze per anastomosi



DE BAKEY REYNOLDS



STI-08-2067
Fig. 1
17,5 cm



STI-08-2068
Fig. 2
17,5 cm



STI-08-2069
Fig. 3
16,5 cm



STI-08-2070
Fig. 3
16,5 cm



SUBRAMANIAN
STI-08-2071
15,0 cm



SUBRAMANIAN
STI-08-2072
16,0 cm



SUBRAMANIAN
STI-08-2073
16,0 cm



OCHSNER
STI-08-2074
23,0 cm

Aortaklemmen
Aortic Clamp
Pince-clamp à aorte
Pinza clamp para aorta
Pinza per aorta



DIETRICH
STI-08-2075
21,0 cm

Präparier- und Ligaturklemmen
Dissecting and Ligature Clamps
Pinces à dissection et passe-fil
Pinzas de disección y para ligaduras
Pinze per dissezione e per legature



DE BAKEY
STI-08-2076
20,0 cm



DE BAKEY

STI-08-2077
19,0 cm

STI-08-2078
23,0 cm

Carotis-Shuntklemmen
Carotid Shunt Clamps
Pinces pour carotide
Pinzas para shunt carótido
Pinze carotis



JAVID
STI-08-2079
18,0 cm



JAVID
STI-08-2080
19,0 cm



SUBRAMANIAN
STI-08-2081
15,0 cm



SUBRAMANIAN
STI-08-2082
16,0 cm



SUBRAMANIAN
STI-08-2083
16,0 cm



OCHSNER
STI-08-2084
23,0 cm

Aortaklemmen
Aortic Clamp
Pince-clamp à aorte
Pinza clamp para aorta
Pinza per aorta



DIETRICH
STI-08-2085
21,0 cm

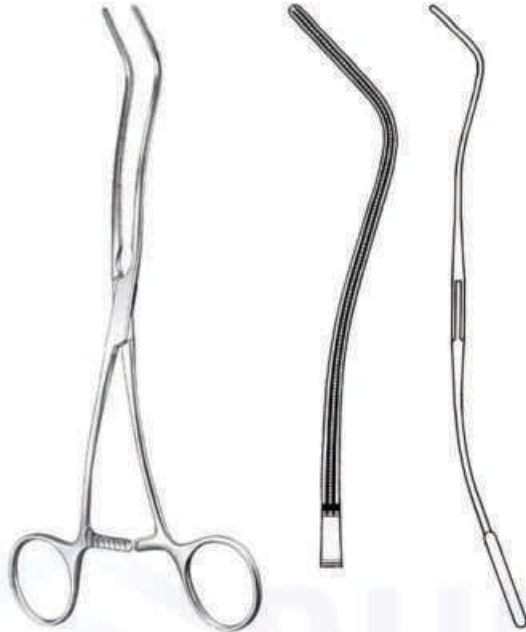

DE BAKEY
STI-08-2086
20,0 cm



DE BAKEY

STI-08-2087
19,0 cm

STI-08-2088
23,0 cm



JAVID
STI-08-2089
18,0 cm

Carotis-Shuntklemmen
Carotid Shunt Clamps
Pincas pour carotide
Pinzas para shunt carótido
Pinze carotis



JAVID
STI-08-2090
19,0 cm

Profunda-Klemmen
 Profunda Clamps
 Pincés-clamps pour profunda
 Pinzas clamps para profunda
 Pinze per profunda



GREGORY

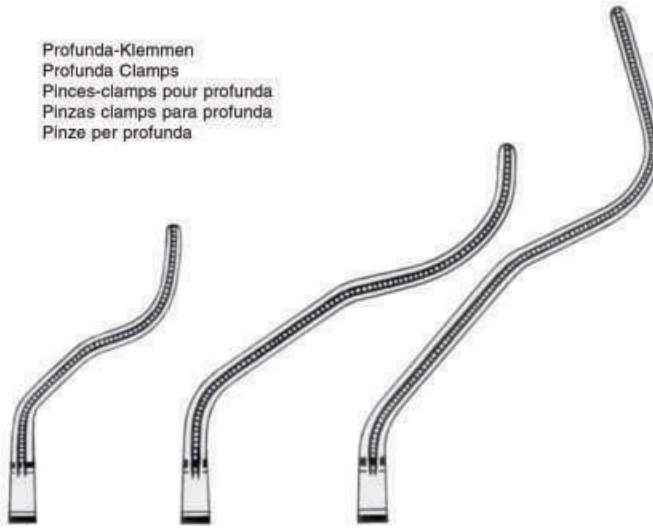

STI-08-2091
 14,0 cm

STI-08-2092
 16,0 cm

STI-08-2093
 18,0 cm



cm — COOLEY
 13,0 **STI-08-2094** **STI-08-2095**



COOLEY
STI-08-2096
 13,5 cm



COOLEY
STI-08-2097
 13,0 cm



COOLEY
 STI-08-2098
 12,5 cm



COOLEY
 STI-08-2099
 10,5 cm



COOLEY
 STI-08-2101
 12,0 cm



COOLEY
 STI-08-2102
 13,5 cm



Fr./Charrière	COOLEY
24	STI-08-2103
26	STI-08-2104
28	STI-08-2105
30	STI-08-2106
32	STI-08-2107
36	STI-08-2108



cm	COOLEY
14,0	STI-08-2109 STI-08-2111
16,0	STI-08-2110 STI-08-2112



COOLEY
 STI-08-2113
 14,0 cm



COOLEY
 STI-08-2114
 14,0 cm



COOLEY
 STI-08-2115
 14,0 cm



COOLEY
STI-08-2116
27,0 cm

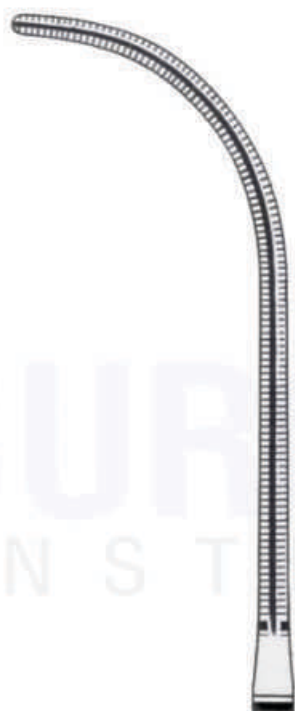

COOLEY
STI-08-2117
17,0 cm

Atraumatische Mehrzweckklemmen
 Atraumatic Multi-Purpose Clamps
 Pincés-clamps polyvalentes
 Pinzas clamps para usos varios
 Pinze atraumatiche per diversi usi



COOLEY



STI-08-2118
17,0 cm



STI-08-2119
17,0 cm



STI-08-2120
17,0 cm

Iliaca-Klemmen
 Iliac Clamps
 Pincés-clamps à iliaque
 Pinzas clamps para ilíaca
 Pinze per ilíaca



COOLEY
 STI-08-2121
21,5 cm



Anastomosenklemmen
 Anastomosis Clamps
 Pincés à anastomose
 Pinzas para anastomosis
 Pinze per anastomosi



COOLEY
 STI-08-2122
17,0 cm





cm — COOLEY —
14,0 STI-08-2123 STI-08-2124



COOLEY
STI-08-2125
14,0 cm



COOLEY
STI-08-2126
14,0 cm



COOLEY



STI-08-2127
15,0 cm

STI-08-2128
16,0 cm

Atraumatische Mehrzweckklemmen
 Atraumatic Multi-Purpose Clamps
 Pincés-clamps polyvalentes
 Pinzas clamps para usos varios
 Pinze atraumatiche per diversi usi



COOLEY
STI-08-2129
 16,5 cm



COOLEY
STI-08-2130
 16,5 cm

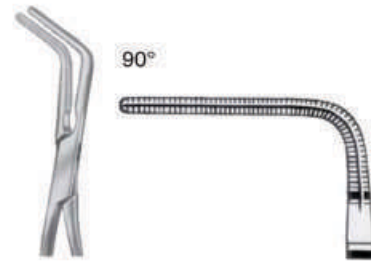

COOLEY
STI-08-2131
 16,5 cm

25°

45°

90°

Anastomosenklemmen
 Anastomosis Clamps
 Pincés à anastomose
 Pinzas para anastomosis
 Pinze per anastomosi



COOLEY
STI-08-2132
 14,0 cm



COOLEY DERRA



STI-08-2133
 16,0 cm



STI-08-2134
 17,0 cm



STI-08-2135
 18,0 cm

Anastomosenklemmen
Anastomosis Clamps
Pinces à anastomose
Pinzas para anastomosis
Pinze per anastomosi



COOLEY
17,0 cm



STI-08-2136
Fig. 1

STI-08-2137
Fig. 2



COOLEY



STI-08-2138
16,0 cm



STI-08-2139
17,5 cm



STI-08-2140
17,5 cm



COOLEY
STI-08-2141
17,0 cm



COOLEY
STI-08-2142
17,0 cm



COOLEY
STI-08-2143
18,0 cm



COOLEY
STI-08-2144
19,0 cm



COOLEY
STI-08-2145
26,0 cm



COOLEY
STI-08-2146
27,0 cm

Neonatal- und Kinderklemmen, extra feine Modelle
Neonatal and Childrens Clamps, extra delicate patterns
Pinces-clamps pour des nouveaux-nés et des enfants, modèles très fins
Pinzas clamps para recién nacidos y niños, modelos muy finos
Pinze pediatriche, modelli molto fini



CASTAÑEDA
STI-08-2147
13,0 cm



CASTAÑEDA
13,0 cm



STI-08-2148
Fig. 1
13,0 cm



STI-08-2149
Fig. 2
13,0 cm

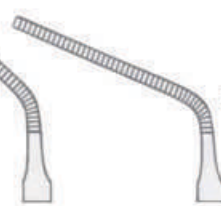

STI-08-2150
Fig. 3
13,0 cm



STI-08-2151
Fig. 4
13,0 cm



CASTAÑEDA
12,0 cm



STI-08-2152
Fig. 1
12,0 cm



STI-08-2153
Fig. 2
12,0 cm



STI-08-2154
Fig. 3
12,0 cm



STI-08-2155
Fig. 4
12,0 cm

Kinder-Gefäßklemmen
 Pediatric Vascular Clamp
 Pincès vasculaires pédiatriques
 Pinzas vasculares pediátricas
 Pinze vascolari pediatriche



gerade
 straight
 droites
 rectas
 rette

STI-08-2156 - STI-08-2164
 Fig. 1-9



abgewinkelt
 angled
 coudées
 acodadas
 angolari

STI-08-2165 - STI-08-2173
 Fig. 1-9



stark abgewinkelt
 strongly angled
 fortement coudées
 fuertemente acodadas
 fortemente angolari

STI-08-2174 - STI-08-2182
 Fig. 1-9



Fig. 1
STI-08-2156
STI-08-2165
STI-08-2174



Fig. 2
STI-08-2157
STI-08-2166
STI-08-2175



Fig. 3
STI-08-2158
STI-08-2167
STI-08-2176



Fig. 4
STI-08-2159
STI-08-2168
STI-08-2177



Fig. 5
STI-08-2160
STI-08-2169
STI-08-2178



Fig. 6
STI-08-2161
STI-08-2170
STI-08-2179



Fig. 7
STI-08-2162
STI-08-2171
STI-08-2180



Fig. 8
STI-08-2163
STI-08-2172
STI-08-2181



Fig. 9
STI-08-2164
STI-08-2173
STI-08-2182



STI-08-2183-STI-08-2188
20,0 cm



STI-08-2183
12 mm



STI-08-2184
20 mm



STI-08-2185
30 mm

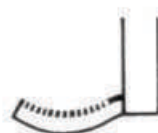

STI-08-2186
12 mm



STI-08-2187
20 mm



STI-08-2188
30 mm

Flexible Gefäßklemmen
Flexible Vessel Clamps
Pinces vasculaires flexibles
Pinzas vasculares flexibles
Pinze vascolari flessibili



STI-08-2189-STI-08-2191



STI-08-2189
ø 3 mm



STI-08-2190
ø 5 mm



STI-08-2191
ø 7 mm



STI-08-2192
ø 9 mm



Towel Clamps

scharf
sharp
aigue
aguda
acute



cm **SCHAEDEL**
9 **STI-09-2192**

scharf
sharp
aigue
aguda
acute



cm **JONES**
5 **STI-09-2193**
9 **STI-09-2194**

scharf
sharp
aigue
aguda
acute



cm **JONES-CLIP**
9 **STI-09-2195**

mit Schlauchhalter
with tube holder
avec clamp porte-tube
con porta-tubo
con porta tubo



cm **BACKHAUS**
9 **STI-09-2196**
11 **STI-09-2197**
13 **STI-09-2198**
15 **STI-09-2199**



graziles Modell
delicate model
modèle gracile
modelo delicato
modello delicato

cm
11 **STI-09-2201**
13 **STI-09-2202**



cm **BACKHAUS KOCHER**
13 **STI-09-2203**

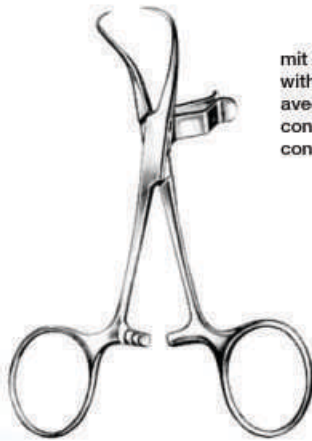

mit Schlauchhalter
 with tube holder
 avec clamp porte-tube
 con porta-tubo
 con porta tubo

cm	BACKHAUS-CLIP
11	STI-09-2204
13	STI-09-2205
15	STI-09-2206



cm	ROEDER
13	STI-09-2207
15	STI-09-2208



weites Maul zur Schlauchfixierung
 wide jaw for tube fixation
 mors large pour fixation de tube
 boca ancha para fijación de tubos
 morso spalancato per fissare il tubo

cm	PEERS BERTRAM
14	STI-09-2209



für Papierabdeckung
 for paper clothes
 pour couverture en papier
 para paños de papel
 per copertura di carta

cm	HOFF
10	STI-09-2210
12	STI-09-2211
14	STI-09-2212



fein gezahnt, breites Maul
fine serrated, wide jaw
cuors large avec deuts fins
boca anca, delicadamente dentada
marso largo, con denti fini

cm	LORNA
9	STI-09-2213
10	STI-09-2214
13	STI-09-2215

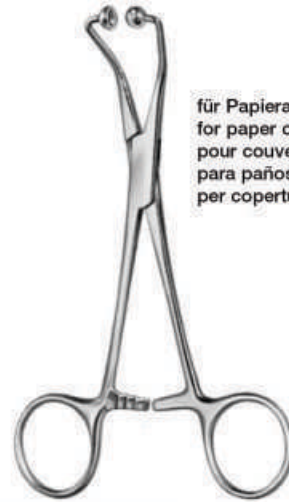

für Papierabdeckung
for paper clothes
pour couverture en papier
para paños de papel
per copertura di carta

cm	BALL AND SOCKET
9	STI-09-2216
10	STI-09-2217
11	STI-09-2218
13	STI-09-2219
14	STI-09-2220
16	STI-09-2221



stumpf
blunt
moussée
roma
smusse

cm	TOHOKU
10	STI-09-2222
13	STI-09-2223



cm	BERNHARD
16,5	STI-09-2224
18	STI-09-2225



cm	MOYNIHAN
19	STI-09-2226





cm	DOYEN
14	STI-09-2227
18	STI-09-2228



cm	LANE
13,0	STI-09-2229
15,0	STI-09-2230
20,0	STI-09-2231



Polypus & Dressing Forceps



	
gerade	gebogen
straight	curved
droites	courbes
rectas	curvas
rette	curve





mit Sperre
 with ratchet
 avec crémaillère
 con cremallera
 con cremagliera

cm  MARTIN 
 25,5 STI-10-2232 STI-10-2233



ohne Sperre
 without ratchet
 sans crémaillère
 sin cremallera
 senza cremagliera

cm  GROSS-MAIER 
 18 STI-10-2234 STI-10-2237
 20 STI-10-2235 STI-10-2238
 25 STI-10-2236 STI-10-2239

	
gerade	gebogen
straight	curved
droites	courbes
rectas	curvas
rette	curve



mit Sperre
with ratchet
avec crémaillère
con cremallera
con cremagliera



ohne Sperre
without ratchet
sans crémaillère
sin cremallera
senza cremagliera

cm		GROSS-MAIER	
18	STI-10-2240		STI-10-2243
20	STI-10-2241		STI-10-2244
25	STI-10-2242		STI-10-2245

cm		GROSS-MAIER	
13	STI-10-2246		STI-10-2248
14	STI-10-2247		STI-10-2249

—	⤿
gerade	gebogen
straight	curved
droites	courbes
rectas	curvas
rette	curve

ohne Sperre
 without ratchet
 sans crémaillère
 sin cremallera
 senza cremagliera



mit Sperre
 with ratchet
 avec crémaillère
 con cremallera
 con cremagliera



cm	—	GROSS-MAIER	⤿
14	STI-10-2250	STI-10-2258	
18	STI-10-2251	STI-10-2259	
20	STI-10-2252	STI-10-2260	
22	STI-10-2253	STI-10-2261	
25	STI-10-2254	STI-10-2262	
27	STI-10-2255	STI-10-2263	
36	STI-10-2256	STI-10-2264	
40	STI-10-2257	STI-10-2265	





cm	—	GROSS-MAIER	⤿
20	STI-10-2266	STI-10-2268	
25	STI-10-2267	STI-10-2269	

	
gerade	gebogen
straight	curved
droites	courbes
rectas	curvas
rette	curve



mit Sperre
with ratchet
avec crémaillère
con cremallera
con cremagliera



cm  GROSS 
18 STI-10-2270 STI-10-2271



mit Sperre
with ratchet
avec crémaillère
con cremallera
con cremagliera

cm  SIMS-MAIER 
28 STI-10-2272 STI-10-2273

Schwammzangen
 Sponge Holding Forceps
 Pincès porte-éponges
 Pinzas porta esponjas
 Pinze per tamponi e spugne



	
gerade	gebogen
straight	curved
droites	courbes
rectas	curvas
rette	curve



mit Sperre
 with ratchet
 avec crémaillère
 con cremallera
 con cremagliera



mit Sperre
 with ratchet
 avec crémaillère
 con cremallera
 con cremagliera

cm		ULRICH	
22	STI-10-2274		STI-10-2277
25	STI-10-2275		STI-10-2278
27	STI-10-2276		STI-10-2279

cm	FOERSTER
25	STI-10-2280

—	⤿
gerade	gebogen
straight	curved
droites	courbes
rectas	curvas
rette	curve





mit Sperre
with ratchet
avec crémaillère
con cremallera
con cremagliera



mit Sperre
with ratchet
avec crémaillère
con cremallera
con cremagliera

cm	—	FOERSTER	⤿
18	STI-10-2281		STI-10-2285
20	STI-10-2282		STI-10-2286
25	STI-10-2283		STI-10-2287
30	STI-10-2284		STI-10-2288

cm	—	FOERSTER	⤿
18	STI-10-2289		STI-10-2293
20	STI-10-2290		STI-10-2294
25	STI-10-2291		STI-10-2295
30	STI-10-2292		STI-10-2296

	
gerade	gebogen
straight	curved
droites	courbes
rectas	curvas
rette	curve



mit Sperre
 with ratchet
 avec crémaillère
 con cremallera
 con cremagliera





cm  **FOERSTER** 
 25 **STI-10-2297** **STI-10-2298**



mit Sperre
 with ratchet
 avec crémaillère
 con cremallera
 con cremagliera

cm **BONNEY**
 24 **STI-10-2299**

	
gerade	gebogen
straight	curved
droites	courbes
rectas	curvas
rette	curve



mit Sperre
with ratchet
avec crémaillère
con cremallera
con cremagliera

cm	RAMPLEY
18	STI-10-2301
25	STI-10-2302



mit Sperre
with ratchet
avec crémaillère
con cremallera
con cremagliera

cm	RAMPLEY
25	STI-10-2303

Schwammzangen
 Sponge Holding Forceps
 Pincès porte-éponges
 Pinzas porta esponjas
 Pinze per tamponi e spugne

—	⤿
gerade	gebogen
straight	curved
droites	courbes
rectas	curvas
rette	curve



mit Sperre
 with ratchet
 avec crémaillère
 con cremallera
 con cremagliera

cm — FLETCHER JAVERTS —
 25 STI-10-2304 STI-10-2305



mit Sperre
 with ratchet
 avec crémaillère
 con cremallera
 con cremagliera

cm — BERGMANN FOERSTER —
 24 STI-10-2306 STI-10-2307

ohne Sperre
without ratchet
sans crémaillère
sin cremallera
senza cremagliera



cm BRYANT
13 **STI-10-2308**

Sinusklemme
Sinus forceps
Pincès à sinus
Pinzas para seno
Pinze sinus



cm LISTER
13 **STI-10-2309**
16 **STI-10-2310**
18 **STI-10-2311**



ohne Sperre
without ratchet
sans crémaillère
sin cremallera
senza cremagliera



mit Sperre
with ratchet
avec crémaillère
con cremallera
con cremagliera



cm COLLIN
25 **STI-10-2312**

Tupferzangen
 Dressing Forceps
 Pincès à pansements
 Pinzas para taponés
 Pinze per medicatura

	
gerade	gebogen
straight	curved
droites	courbes
rectas	curvas
rette	curve



mit Sperre
 with ratchet
 avec crémaillère
 con cremallera
 con cremagliera



cm  PELKMANN 
 25 STI-10-2313 STI-10-2314



cm CHERON
 25 STI-10-2315





cm MAIER
 25 STI-10-2316

	
gerade	gebogen
straight	curved
droites	courbes
rectas	curvas
rette	curve



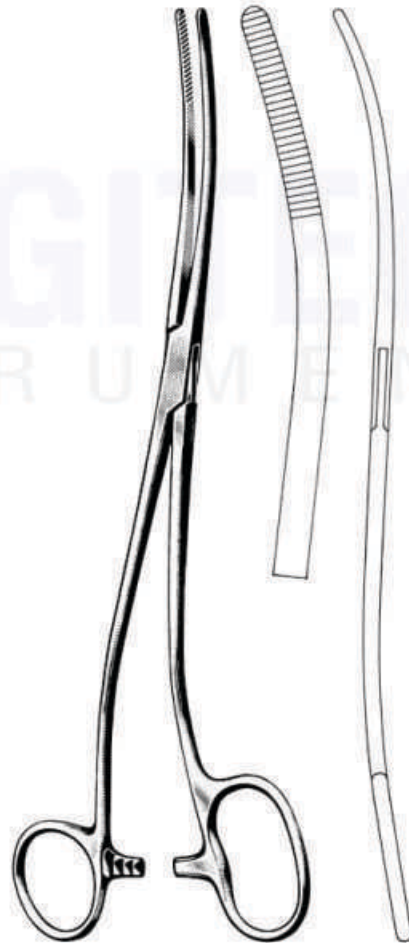

mit Sperre
with ratchet
avec crémaillère
con cremallera
con cremagliera

cm  BOZEMANN 
26 STI-10-2317 STI-10-2318





mit Sperre
with ratchet
avec crémaillère
con cremallera
con cremagliera

cm BOZEMANN-DOUGLAS
26 STI-10-2319

	
gerade	gebogen
straight	curved
droites	courbes
rectas	curvas
rette	curve





mit Sperre
 with ratchet
 avec crémaillère
 con cremallera
 con cremagliera

cm  MARTIN 
 17 STI-10-2320 STI-10-2321



mit Sperre
 with ratchet
 avec crémaillère
 con cremallera
 con cremagliera

cm  DUPLAY 
 20 STI-10-2322 STI-10-2323

Retractors

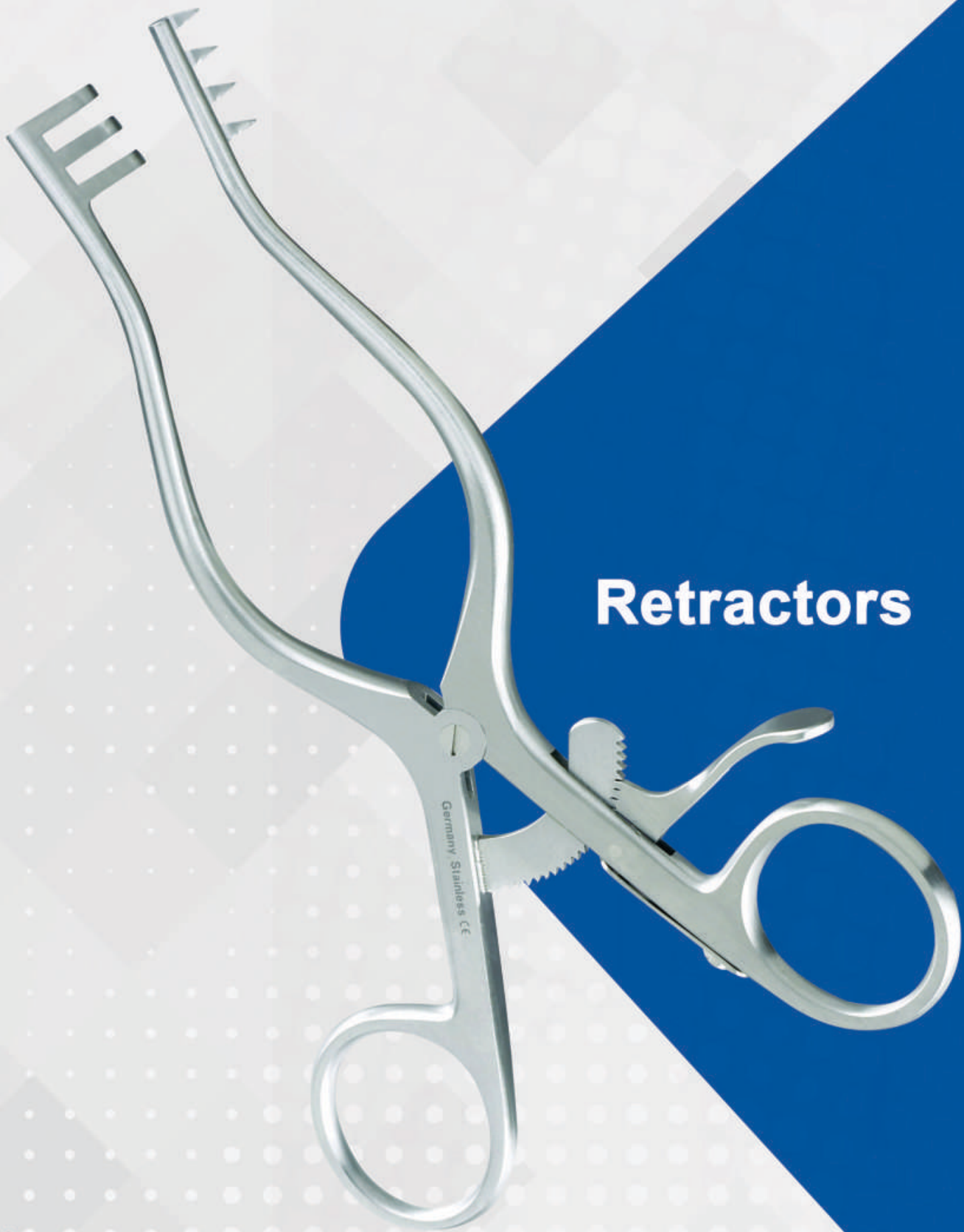

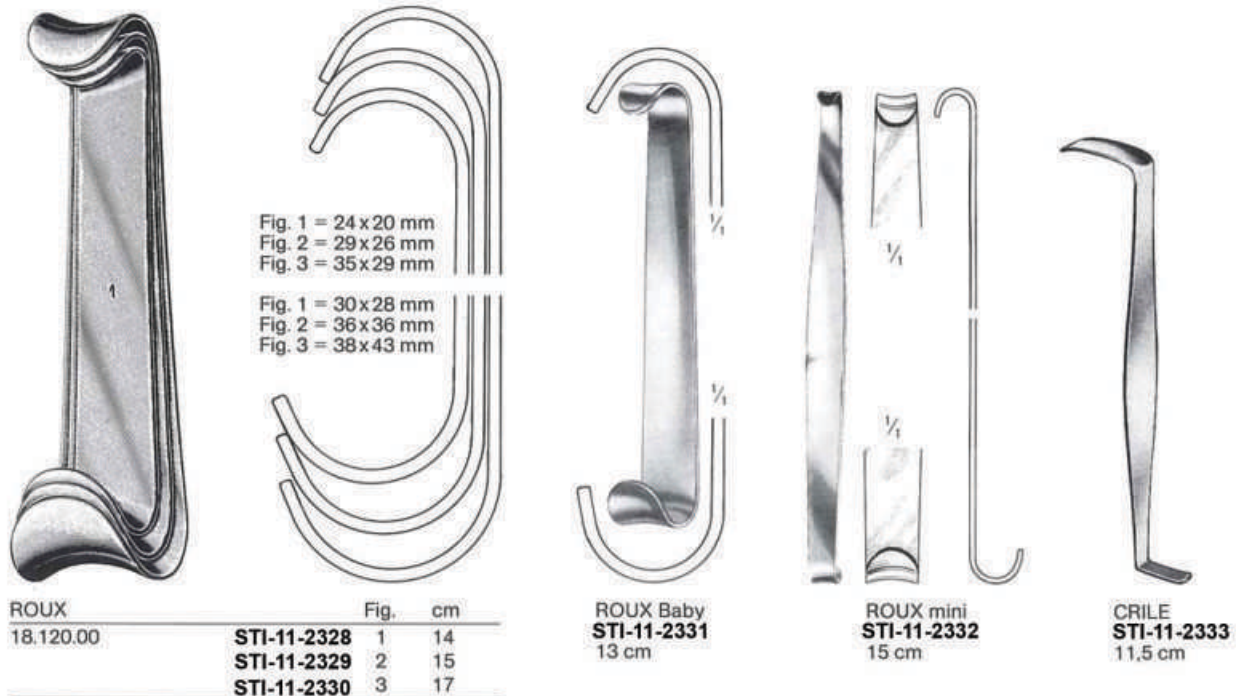



US Army (PARKER-LANGENBECK)
STI-11-2334
21 cm



MATHIEU
STI-11-2335
20 cm



GOLET
STI-11-2336
19 cm



COLLIN-HARTMANN
STI-11-2337
16 cm

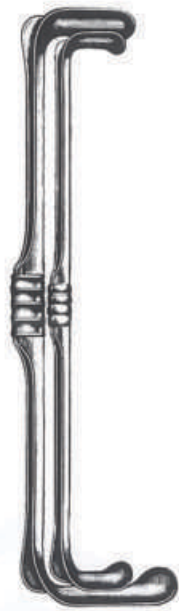

RICHARDSON-EASTMAN
STI-11-2338

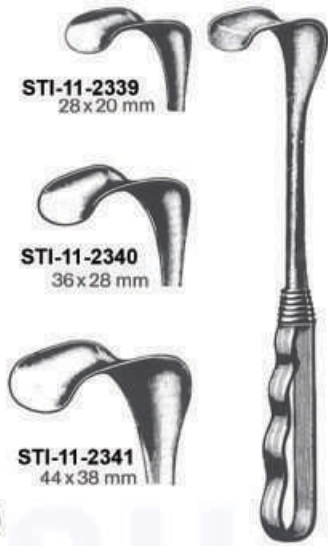

STI-11-2339
28 x 20 mm

STI-11-2340
36 x 28 mm

STI-11-2341
44 x 38 mm

RICHARDSON



RICHARDSON Grip
STI-11-2342 20 x 25 mm
STI-11-2343 25 x 31 mm
STI-11-2344 38 x 38 mm
STI-11-2345 19 x 51 mm (Append.)
STI-11-2346 41 x 64 mm



65 x 50 mm

KELLY
STI-11-2347
26 cm

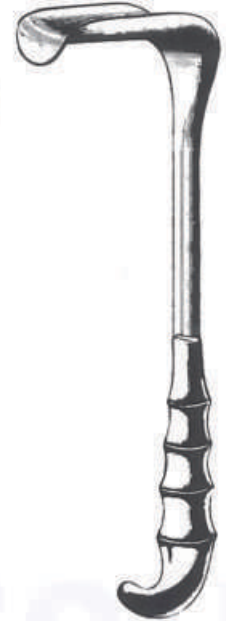

KELLY Grip
STI-11-2348 38 x 51 mm
STI-11-2349 51 x 64 mm
STI-11-2350 64 x 76 mm
STI-11-2351 70 x 82 mm

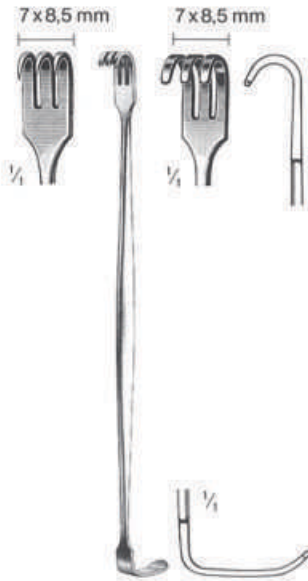

SENN
STI-11-2352 17 cm **STI-11-2353**



RIBBON
STI-11-2354 12 x 200 mm
STI-11-2355 17 x 200 mm
STI-11-2356 25 x 250 mm



RIBBON
STI-11-2357 25 x 330
STI-11-2358 32 x 330
STI-11-2359 40 x 330
STI-11-2360 50 x 330



HABERER
STI-11-2361 17/25 x 200 mm
STI-11-2362 25/30 x 250 mm
STI-11-2363 37/45 x 300 mm



REVERDIN
STI-11-2364
28 cm



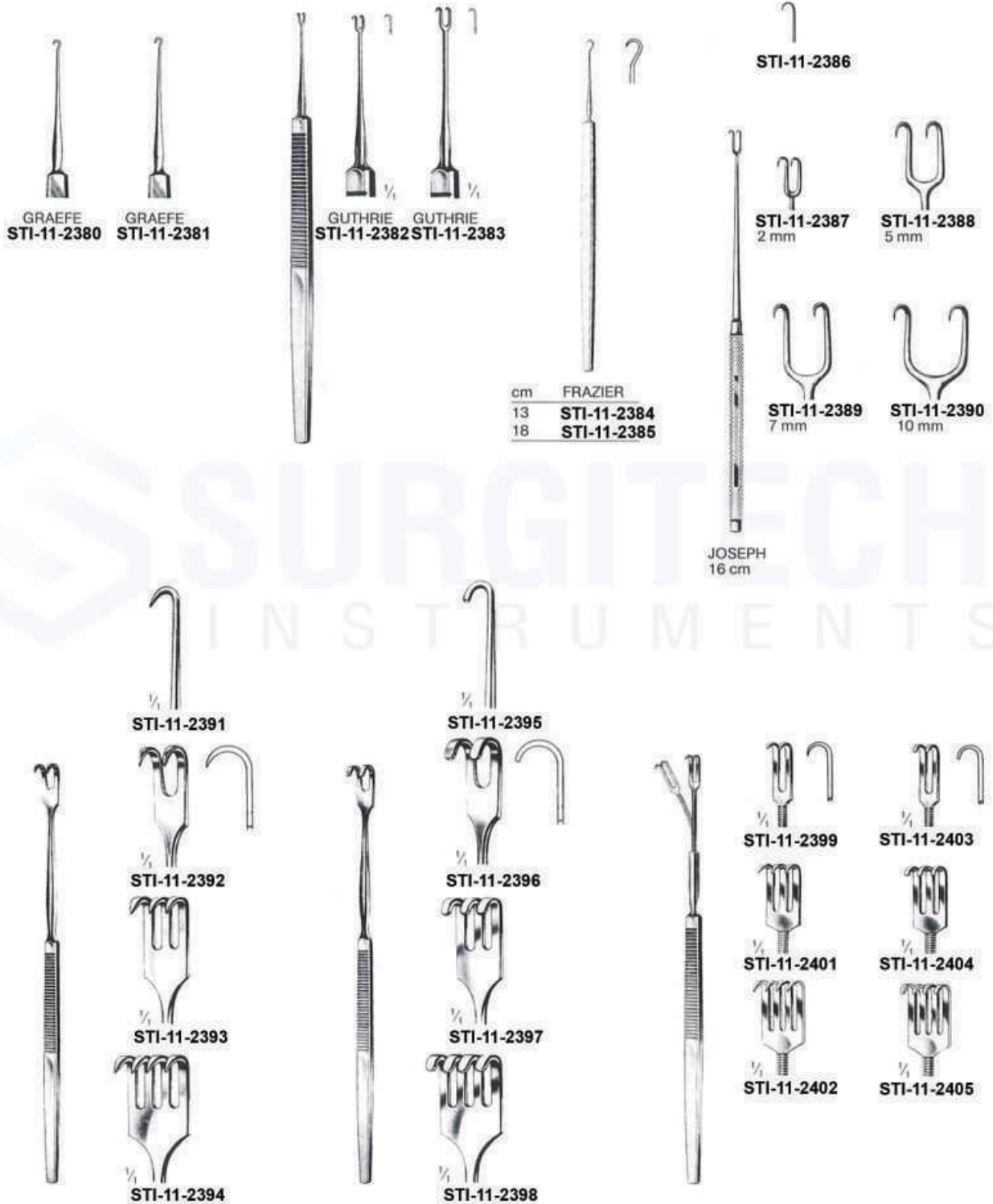

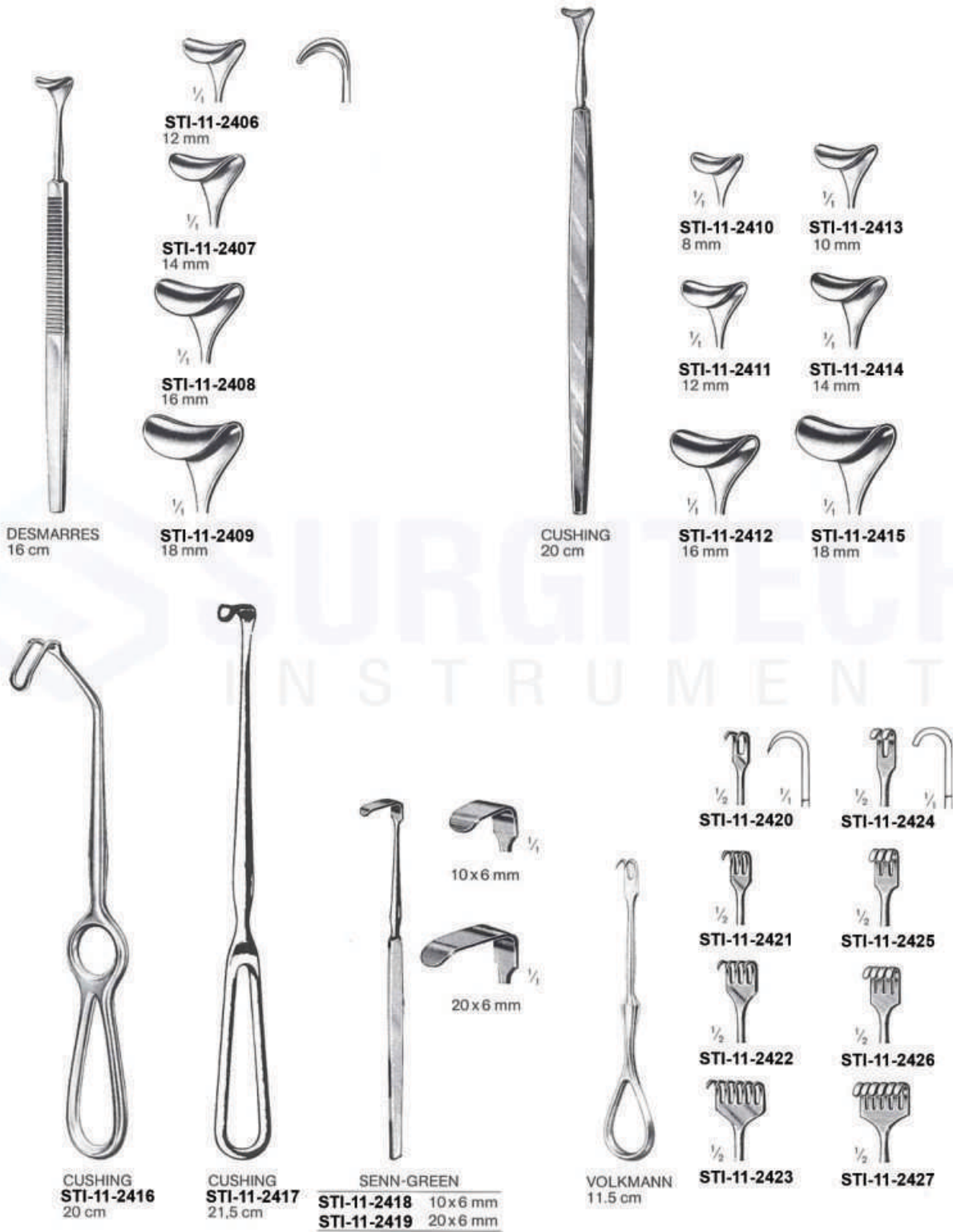



VOLKMANN
 21.5 cm



1/4



1/2

STI-11-2428



1/2

STI-11-2429



1/2

STI-11-2430



1/2

STI-11-2431



1/2

STI-11-2432



1/4

STI-11-2433



1/2

STI-11-2434



1/2

STI-11-2435



1/2

STI-11-2436



1/2

STI-11-2437



1/2

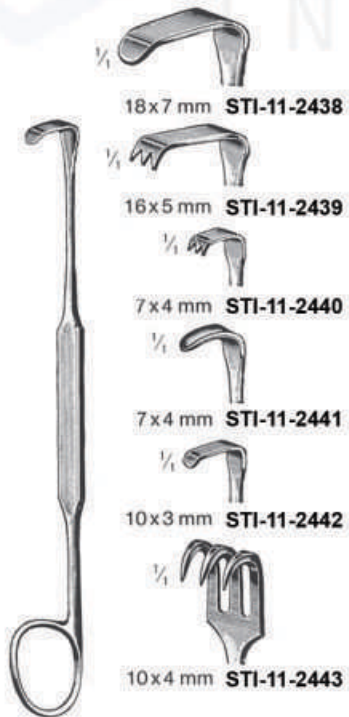

1/4

18x7 mm STI-11-2438

1/4

16x5 mm STI-11-2439

1/4

7x4 mm STI-11-2440

1/4

7x4 mm STI-11-2441

1/4

10x3 mm STI-11-2442

1/4

10x4 mm STI-11-2443

MEYERDING
 18 cm



28x6 mm

LAHEY
STI-11-2444
 19 cm

12x14 mm



LITTLE
STI-11-2445
 20 cm



**STI-11-2446-
STI-11-2450**
22 cm



**STI-11-2451-
STI-11-2455**
21 cm

LANGENBECK

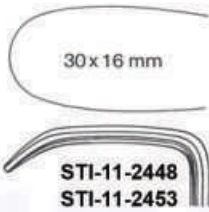
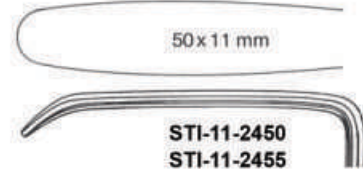
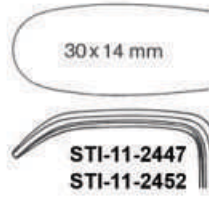
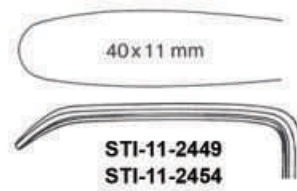

STI-11-2456 60x20 mm



STI-11-2457 35x7 mm



STI-11-2458 35x10 mm



STI-11-2459 35x15 mm



60x20 mm

$\frac{1}{4}$



85x15 mm

$\frac{1}{4}$

LANGENBECK
STI-11-2456-2459
21 cm

LANGENBECK
STI-11-2460
21 cm

LANGENBECK
STI-11-2461
21 cm



STI-11-2462
 78x40 mm

STI-11-2463
 57x25 mm

STI-11-2464
 40x18 mm



STI-11-2465
 40x12 mm

STI-11-2466
 55x11 mm



EV-11-2467
 19x12 mm

STI-11-2468
 21x14 mm

KOCHER
STI-11-2467-2468
 19 cm



KOCHER
STI-11-2462-2464
 23 cm

KOCHER
STI-11-2465-2466
 19 cm



STI-11-2472
 14x17 mm
 21,5 cm

STI-11-2473
 20x22 mm
 22 cm

STI-11-2474
 26x30 mm
 23,5 cm

MIDDENDORP
STI-11-2472-2474



GREEN
STI-11-2475
 22 cm



OLLIER
STI-11-2476
 22,5 cm

KOCHER mm
STI-11-2469 40x10
STI-11-2470 40x15
STI-11-2471 40x20
 22 cm



ISRAEL
25 cm

STI-11-2477 40x40 mm



STI-11-2478 45x50 mm



STI-11-2479 50x60 mm



STI-11-2480 70x70 mm



40x30 mm

KOERTE
STI-11-2481 23,5 cm STI-11-2482



FRITSCH mm
STI-11-2483 45x40
STI-11-2484 45x50
STI-11-2485 45x60
STI-11-2486 45x75
24 cm



70x25 mm

KOCHER
STI-11-2487
22,5 cm

KOCHER mm
STI-11-2488 80x45
STI-11-2489 80x55
STI-11-2490 80x65
25 cm



50 x 85 mm

DOYEN
STI-11-2491
 25 cm



mm	KELLY
160 x 38	STI-11-2084
160 x 57	STI-11-2085
	27 cm



SIMON	mm
STI-11-2086	115 x 22
STI-11-2087	115 x 27
	28 cm



90 x 50 mm

STI-11-2492
 95 x 35 mm

STI-11-2493
 120 x 50 mm

STI-11-2494
 150 x 50 mm

MIKULICZ
 26 cm

MIKULICZ
 26 cm



STI-11-2495
 82 x 28 mm

STI-11-2496
 73 x 28 mm

1/2

MIKULICZ
STI-11-2498
 26 cm

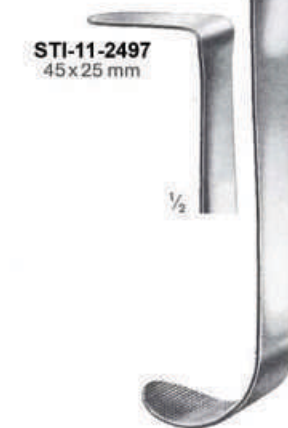

STI-11-2497
 45 x 25 mm

1/2

HEANEY
STI-11-2495-2497
 27 cm



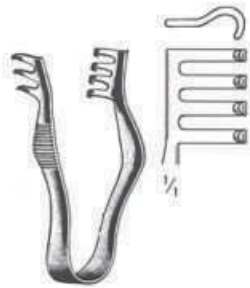

FINSEN
STI-11-2509 7 cm STI-11-2510

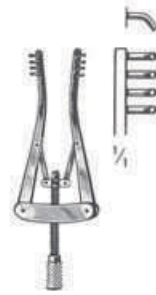

ALM
STI-11-2511 7 cm STI-11-2513
STI-11-2512 10 cm STI-11-2514

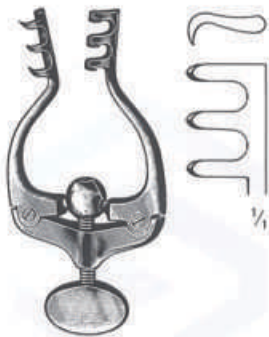

JANSEN
STI-11-2515
10 cm



JANSEN
STI-11-2516
10 cm



DIMEDA
STI-11-2517 10cm STI-11-2518

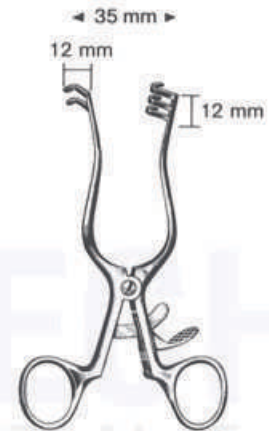

WEITLANER
STI-11-2519 11,5cm STI-11-2520

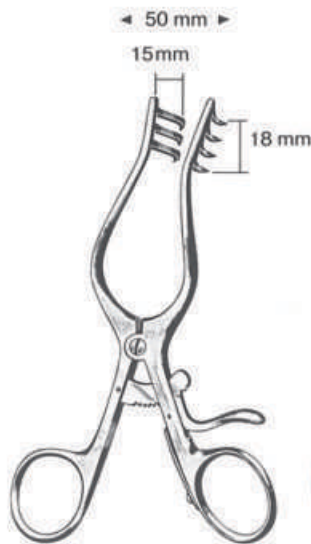

WEITLANER-WULLSTEIN
STI-11-2521 13 cm STI-11-2522



PLESTER
STI-11-2523
11 cm



PLESTER
STI-11-2524
11 cm

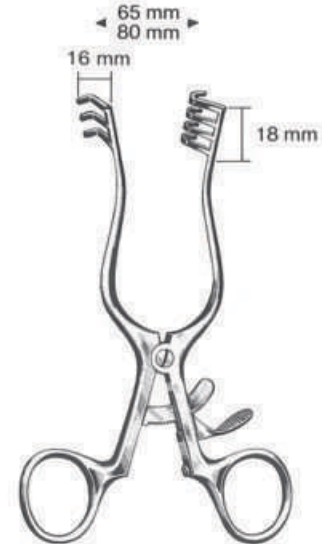

WEITLANER
STI-11-2525 14,0 cm 18.671.14
STI-11-2526 16,5 cm 18.671.16
STI-11-2527 20,0 cm 18.671.20

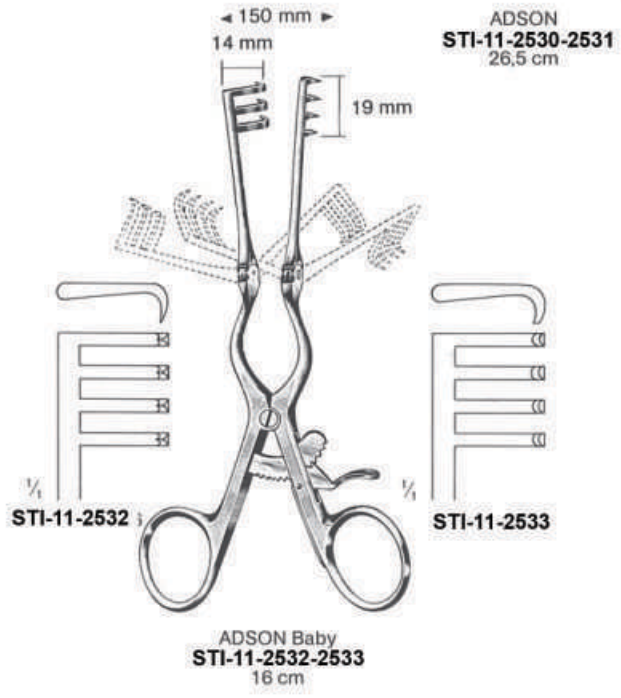
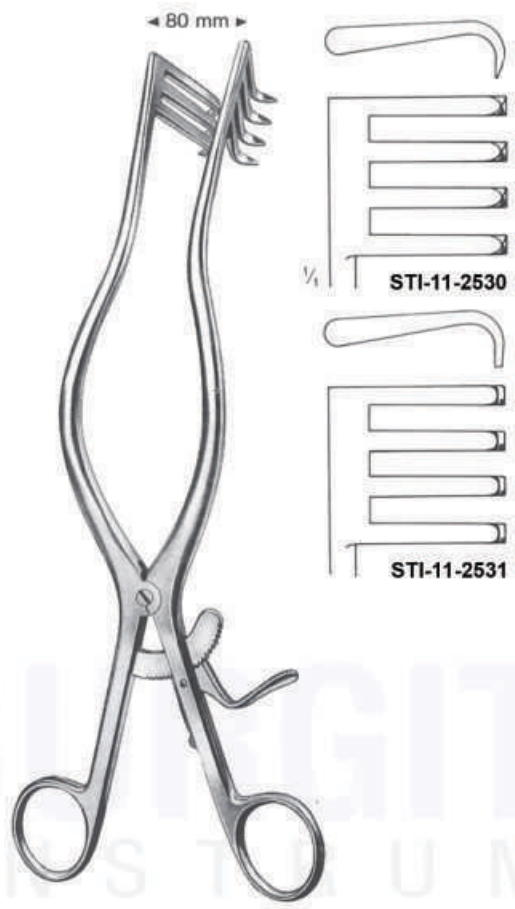



BECKMANN
STI-11-2535
31 cm



BECKMANN-EATON
STI-11-2536
32 cm

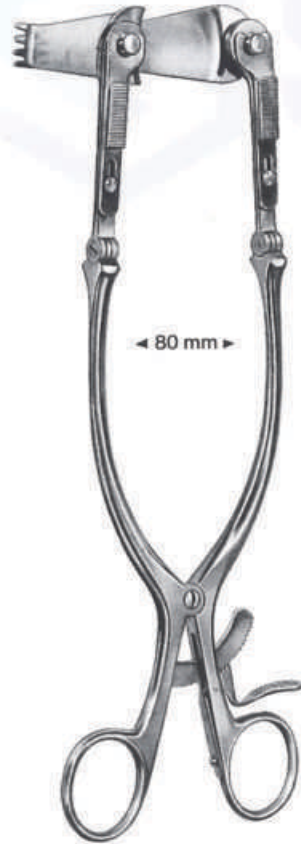
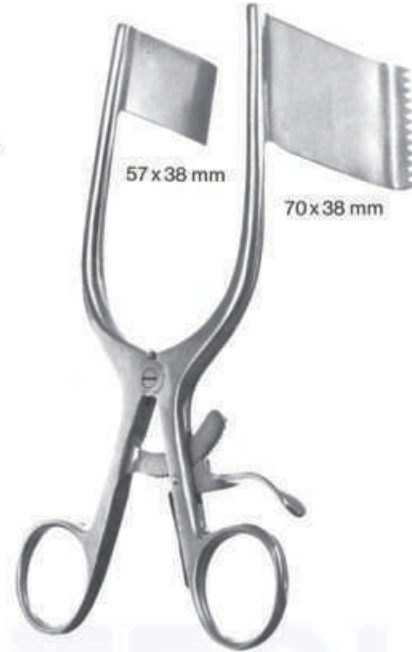

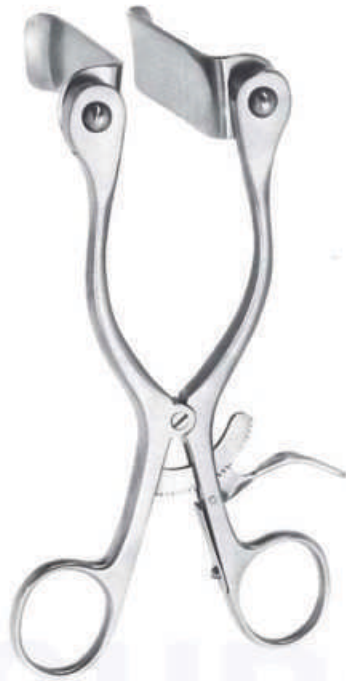

CASPAR
STI-11-2554 compl.
STI-11-2555 ohne Valven · without blades
sans valves · sin valvas · senza valve



CASPAR
STI-11-2556 compl.
STI-11-2557 ohne Valven · without blades · sans valves · sin valvas · senza valve



CASPAR
 STI-11-2558 compl.
 STI-11-2559



stumpf
 blunt
 mousse
 roma
 smussa

mm	CASPAR
45x23	STI-11-2560
50x23	STI-11-2561
55x23	STI-11-2562
60x23	STI-11-2563
65x23	STI-11-2564



medial

mm	CASPAR
40x23	STI-11-2565
45x23	STI-11-2566
50x23	STI-11-2567
55x23	STI-11-2568
60x23	STI-11-2569



lateral

mm	CASPAR
40x23	STI-11-2570
45x23	STI-11-2571
50x23	STI-11-2572
55x23	STI-11-2573
60x23	STI-11-2574

STI-11-2575
 40 mm



STI-11-2576
 45 mm



STI-11-2577
 50 mm



STI-11-2578
 55 mm



STI-11-2579
 60 mm



STI-11-2580
 65 mm



STI-11-2581
 70 mm



CASPAR

STI-11-2582 compli incl. 5 Valven · blades
 valves · valvas · valve

STI-11-2583 ohne Valven · without blades · sans valves · sin valvas · senza valve



STI-11-2584
 45 mm

STI-11-2585
 50 mm

STI-11-2586
 55 mm

STI-11-2587
 60 mm

STI-11-2588
 65 mm



CASPAR
STI-11-2584-2588



O'SULLIVAN-O'CONNOR
STI-11-2589

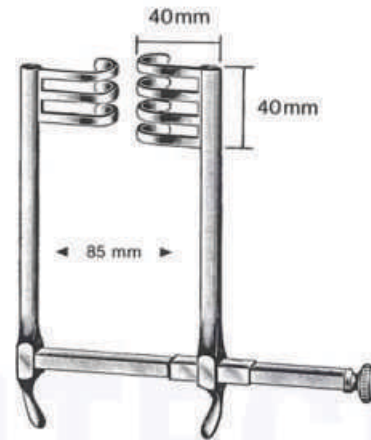

FRAZIER
STI-11-2590

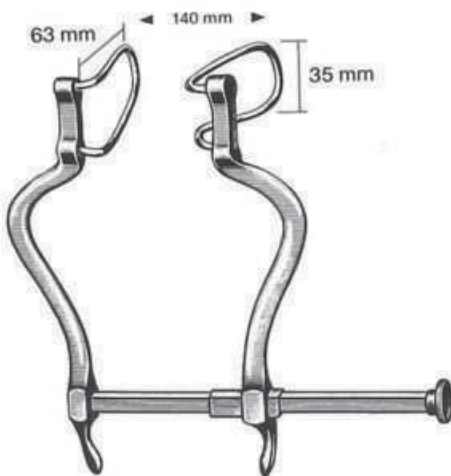

GOSSET
STI-11-2591



GOSSET
STI-11-2592

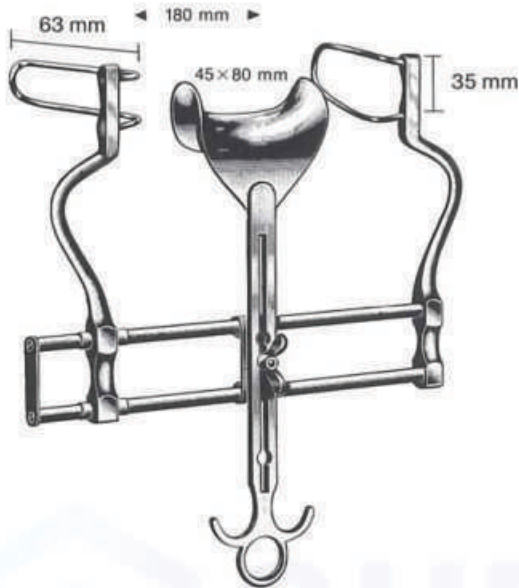

BALFOUR
STI-11-2593
 18 cm

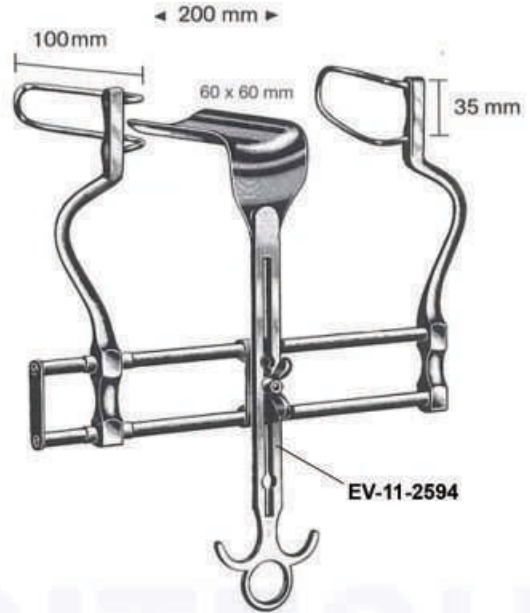

BALFOUR
STI-11-2595
 20 cm

EV-11-2594

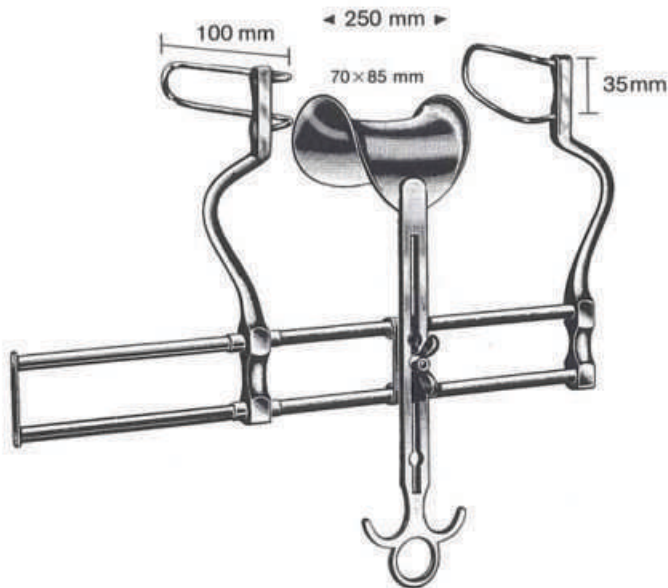

BALFOUR
STI-11-2596
 25 cm



mm	BALFOUR
45 x 80	STI-11-2597
70 x 85	STI-11-2598
80 x 90	STI-11-2599

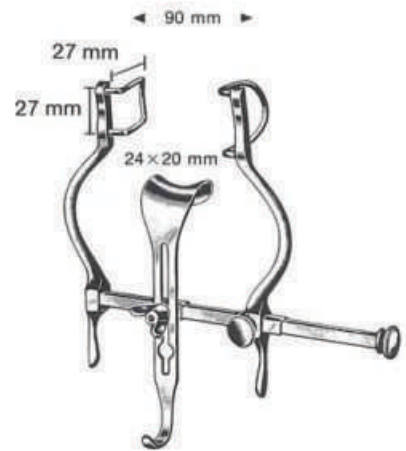

BALFOUR Baby
STI-11-2601
 9 cm

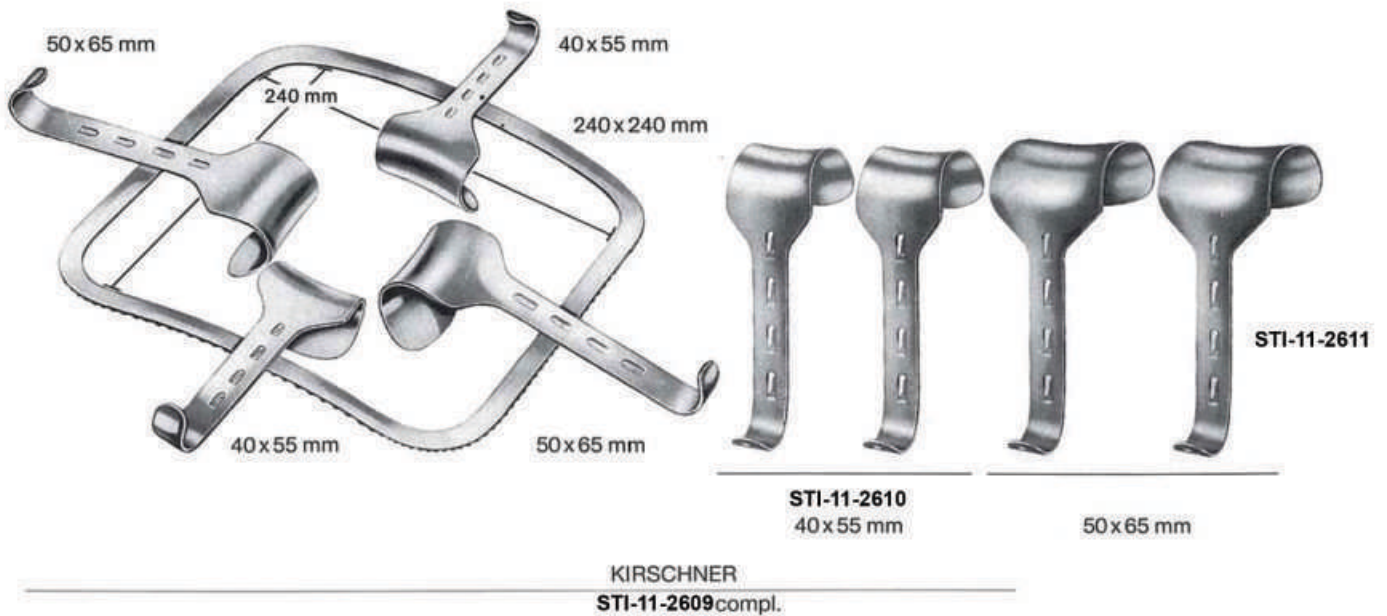
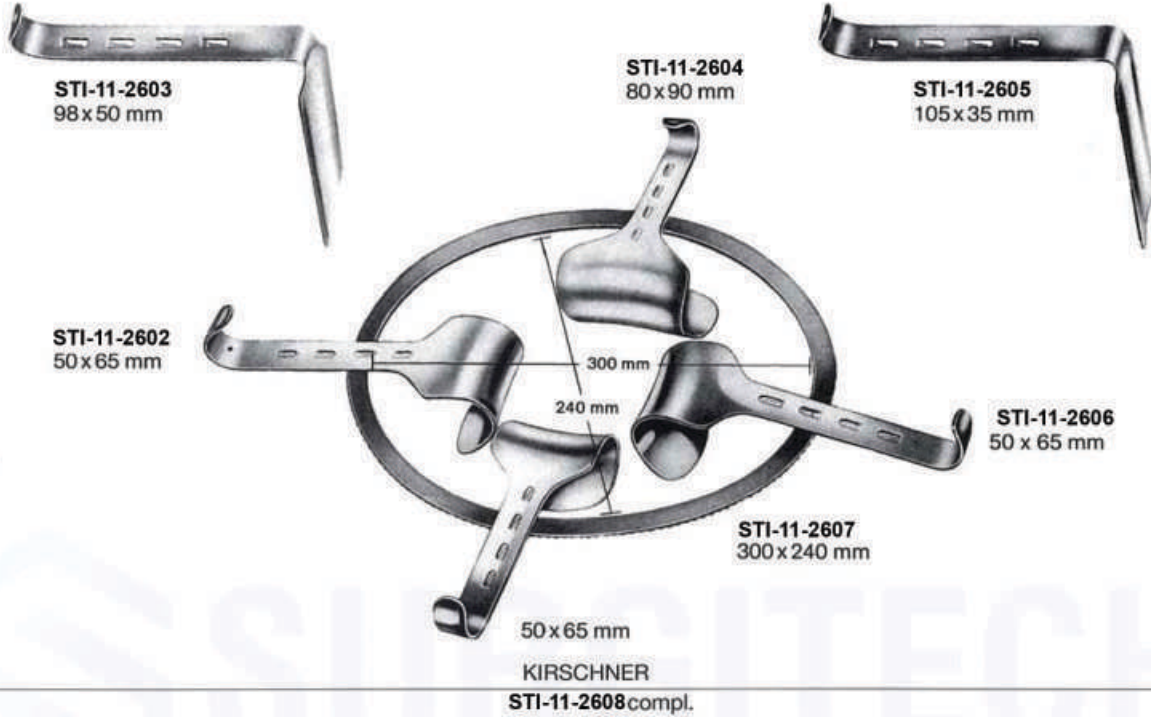



cm	GELPI
9	STI-11-2612
14	STI-11-2613
16	STI-11-2614
18	STI-11-2615



GELPI
 STI-11-2616
 18 cm



RIGBY
 STI-11-2617
 18 cm

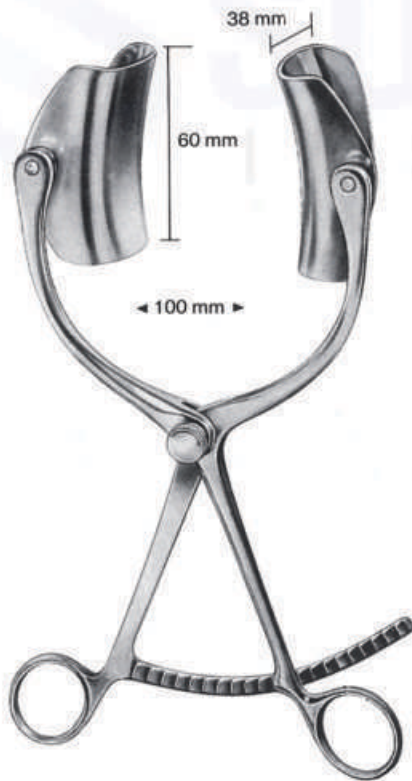

COLLIN
 STI-11-2618



Central/mm	COLLIN
38x55	STI-11-2619
50x75	STI-11-2620



COLLIN Loktite
STI-11-2621

Muskelhaken
Muscle Retractors (Hooks)
Ecarteurs musculaires
Separadores (ganchos) musculares
Divaricatori (uncini) muscolari



STI-11-2622
10 cm



STI-11-2623

Probes, Spatulas, Applicators





cm	2 mm Ø	1 mm Ø	1,5 mm Ø	2 mm Ø	DOYEN		STACKE
10,5							STI-12-2669
11,5	STI-12-2624	STI-12-2631	STI-12-2638	STI-12-2645	STI-12-2652	STI-12-2658	
13,0	STI-12-2625	STI-12-2632	STI-12-2639	STI-12-2646	STI-12-2653	STI-12-2659	STI-12-2665
14,0						STI-12-2660	
14,5	STI-12-2626	STI-12-2633	STI-12-2640	STI-12-2647	STI-12-2654	STI-12-2661	STI-12-2666
16,0	STI-12-2627	STI-12-2634	STI-12-2641	STI-12-2648	STI-12-2655	STI-12-2662	STI-12-2667
18,0	STI-12-2628	STI-12-2635	STI-12-2642	STI-12-2649	STI-12-2656	STI-12-2663	STI-12-2668
20,0	STI-12-2629	STI-12-2636	STI-12-2643	STI-12-2650	STI-12-2657	STI-12-2664	
25,0	STI-12-2630	STI-12-2637	STI-12-2644	STI-12-2651			



NABATOFF
STI-12-2670
135 x 100 x 25 mm
compl.



STI-12-2671



Varizenbesteck
Varicose vein probe set
Trousse à varices
Desobliterador
Astuccio per varici

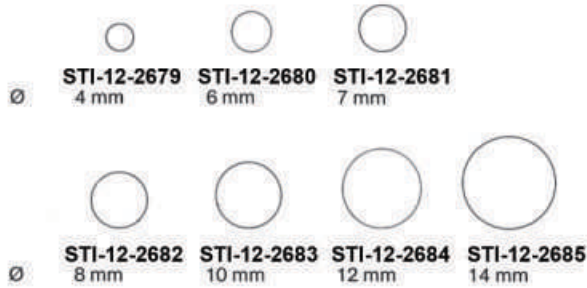

Pflasterspatel
Plaster spatula
Spatules
Espátulas
Spatole



cm
13,0 **STI-12-2687**
14,5 **STI-12-2688**



cm	FARRELL	FARRELL	DIMEDA	UCKERMANN	JOBSON-HORNE
12,0	STI-12-2689	STI-12-2694	STI-12-2699	STI-12-2704	STI-12-2709
14,0	STI-12-2690	STI-12-2695	STI-12-2701	STI-12-2705	
15,0				STI-12-2708	
16,0			STI-12-2702	STI-12-2706	
16,5	STI-12-2691	STI-12-2696			
18,0	STI-12-2692	STI-12-2697	STI-12-2703	STI-12-2707	STI-12-2710
23,0	STI-12-2693	STI-12-2698			
25,0					
45,0					STI-12-2711



Trocars, Puncture Needles



mm	Standard	Standard	PIERCE
3,0	STI-13-2713	STI-13-2720	STI-13-2727
3,5	STI-13-2714	STI-13-2721	
4,0	STI-13-2715	STI-13-2722	STI-13-2728
4,5	STI-13-2716	STI-13-2723	
5,0	STI-13-2717	STI-13-2724	STI-13-2729
5,5	STI-13-2718	STI-13-2725	
6,0	STI-13-2719	STI-13-2726	



DOUGLAS
STI-13-2730
3 mm Ø

FLEURANT
STI-13-2731
23 cm
5 mm Ø

LICHTWITZ
STI-13-2732
1,70 mm Ø

COAKLEY
STI-13-2733
2,25 mm Ø

Charr./ F.G.	OCHSNER
10	STI-13-2734
12	STI-13-2735
14	STI-13-2736
16	STI-13-2737
18	STI-13-2738
20	STI-13-2739

Charr./ F.G.	NELSON
25	EV-13-2740
30	EV-13-2741
33	EV-13-2742
35	EV-13-2743

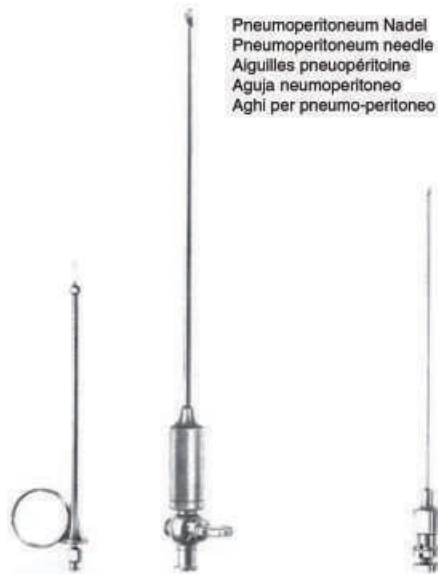

Pneumoperitoneum Nadel
Pneumoperitoneum needle
Aiguilles pneumopéritoine
Aguja neumoperitoneo
Aghi per pneumo-peritoneo

STI-13-2744
compl.

VERRES
STI-13-2745
2,0 x 100 mm

mm	QUINKE
1,2 x 76	STI-13-2746
1,2 x 89	STI-13-2747
1,0 x 76	STI-13-2748
1,0 x 89	STI-13-2749
0,7 x 76	STI-13-2750
0,7 x 89	STI-13-2751



mm	MENGHINI	mm	MENGHINI	mm	MENGHINI
1,0 x 35	STI-13-2752	1,4 x 168	STI-13-2760	1,4 x 168	STI-13-2762
1,0 x 70	STI-13-2753	1,8 x 168	STI-13-2761		STI-13-2763
1,2 x 70	STI-13-2754				
1,2 x 100	STI-13-2755				
1,4 x 70	STI-13-2756				
1,4 x 100	STI-13-2757				
1,6 x 70	STI-13-2758				
1,8 x 100	STI-13-2759				

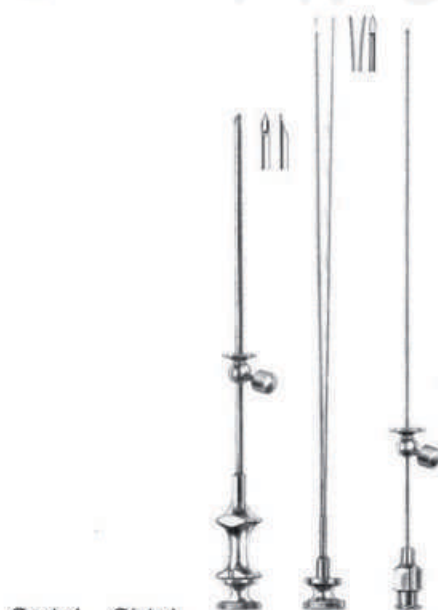

Ø ext. x L. mm	Ø int. x L. mm	FRANKLIN-SILVERMANN
2,0 x 105	1,5 x 155	STI-13-2764
2,0 x 130	1,5 x 180	STI-13-2765

compl.



A Ø x L. mm	B Ø x L. mm	A + B FRANKLIN-SILVERMANN
2,0 x 100	1,5 x 150	STI-13-2766 STI-13-2770
2,5 x 145	2,0 x 195	STI-13-2767 STI-13-2771
2,0 x 100	1,5 x 150	STI-13-2768 STI-13-2772
2,5 x 145	2,0 x 195	STI-13-2769 STI-13-2773



Needle Holders

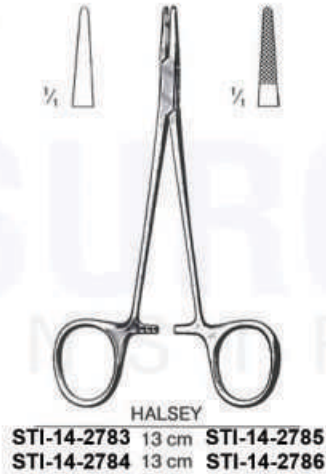
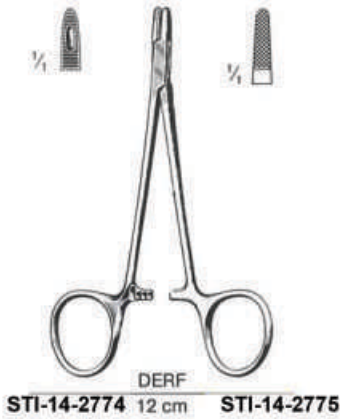

Mit TC-Einsätzen
TC Lined
A mors TC
Con bocas TC
Con morso TC

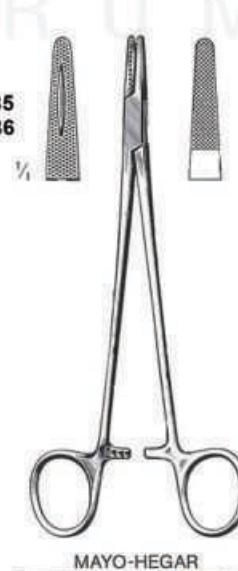

STI-14-2787 15 cm STI-14-2790 15 cm
STI-14-2788 18 cm STI-14-2791 18 cm
STI-14-2789 20 cm STI-14-2792 20 cm

MAYO-HEGAR
STI-14-2795 14 cm STI-14-2803 14 cm
STI-14-2796 16 cm STI-14-2804 16 cm
STI-14-2797 18 cm STI-14-2805 18 cm
STI-14-2798 20 cm STI-14-2806 20 cm
STI-14-2799 24 cm STI-14-2807 24 cm
STI-14-2801 26 cm STI-14-2808 26 cm
STI-14-2802 30 cm STI-14-2809 30 cm

MAYO-HEGAR
STI-14-2810 16 cm STI-14-2813 16 cm
STI-14-2811 18 cm STI-14-2814 18 cm
STI-14-2812 20 cm STI-14-2815 20 cm



cm	DE BAKEY	RYDER
13		STI-14-2823
15	STI-14-2816	STI-14-2824
18	STI-14-2817	STI-14-2825
20	STI-14-2818	STI-14-2826
23	STI-14-2819	STI-14-2827
26	STI-14-2820	STI-14-2828
31	STI-14-2821	
37	STI-14-2822	

cm	JAMISON	HEANEY
23,5	STI-14-2829	STI-14-2831
27	STI-14-2830	STI-14-2832



cm	MASSON	WANGENSTEEN	WANGENSTEEN
27	STI-14-2833	STI-14-2834	STI-14-2836
27			STI-14-2837
27			STI-14-2838

cm	BOZEMANN
20	STI-14-2839
24	STI-14-2840
26	STI-14-2841



METZENBAUM
STI-14-2842
18 cm



ADSON
STI-14-2843
18 cm

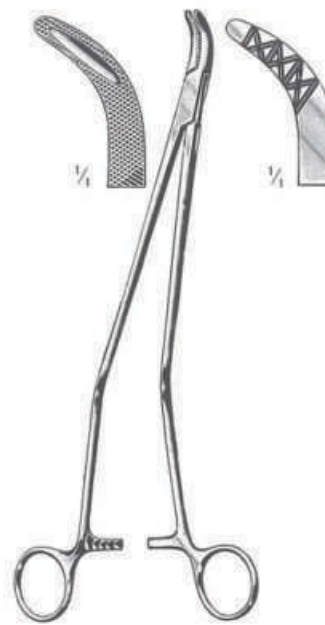

JOHNSON
STI-14-2844
27 cm



FINOCHIETTO
STI-14-2845 20 cm **STI-14-2847**
STI-14-2846 27 cm **STI-14-2848**

Mit TC-Einsätzen
TC Lined
A mors TC
Con bocas TC
Con morso TC



SAROT
STI-14-2849 18 cm **STI-14-2851**
STI-14-2850 26 cm **STI-14-2852**

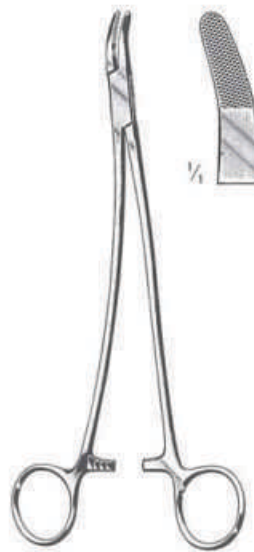

STRATTE
STI-14-2853 23 cm **STI-14-2854**



CRILE
STI-14-2855
15 cm



TOENNIS
STI-14-2856 18cm **STI-14-2857**



HOESEL
EV-14-2858
25 cm



MATHIEU



MATHIEU



MATHIEU

cm	MATHIEU		MATHIEU		MATHIEU	
14	STI-14-2859	STI-14-2863			STI-14-2871	STI-14-2873
17	STI-14-2860	STI-14-2864	STI-14-2867	STI-14-2869	STI-14-2872	STI-14-2874
20	STI-14-2861	STI-14-2865	STI-14-2868	STI-14-2870		
24	STI-14-2862	STI-14-2866				



OLSEN-HEGAR
STI-14-2875 14 cm STI-14-2877
STI-14-2876 18 cm STI-14-2878



OLSEN-HEGAR
STI-14-2879 17 cm STI-14-2880



GILLIES
STI-14-2881 16 cm



STI-14-2882

Gefäß-Chirurgie
Vascular surgery
Chirurgie vasculaire
Cirugia vascular
Chirurgia vascolare



Mit TC-Einsätzen
TC Lined
A mors TC
Con bocas TC
Con morso TC

cm	DIETRICH
16	STI-14-2883
18	STI-14-2884
20	STI-14-2885
23	STI-14-2886
26	STI-14-2887

Ophthalmologie
Ophthalmology
Ophtalmologie
Oftalmologia
Oftalmologia



STEVENS
STI-14-2888
11 cm



cm	STEVENS
13	STI-14-2889
15	STI-14-2890



BOYNTON
STI-14-2891
12 cm



cm	ARRUGA
16	STI-14-2892
	STI-14-2893



KALT-ARRUGA
STI-14-2894
14 cm



KALT
STI-14-2895
STI-14-2896
14 cm



BARRAQUER
STI-14-2897
10 cm



BARRAQUER
STI-14-2898
10 cm



BARRAQUER
STI-14-2899 13cm **STI-14-2901**



CASTROVIEJO
STI-14-2902 14 cm **STI-14-2904**
STI-14-2903 14 cm **STI-14-2905**



CASTROVIEJO
STI-14-2906 13 cm **STI-14-2907**



Suture



R	DESCHAMPS	L
STI-15-2908	21 cm	STI-15-2911
STI-15-2909	24 cm	STI-15-2912
STI-15-2910	27 cm	STI-15-2913

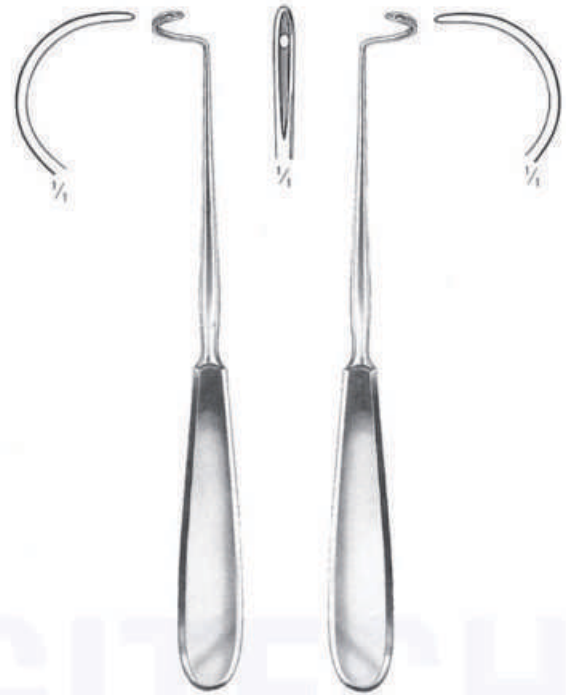

R	DESCHAMPS	L
STI-15-2914	21 cm	STI-15-2917
STI-15-2915	24 cm	STI-15-2918
STI-15-2916	27 cm	STI-15-2919

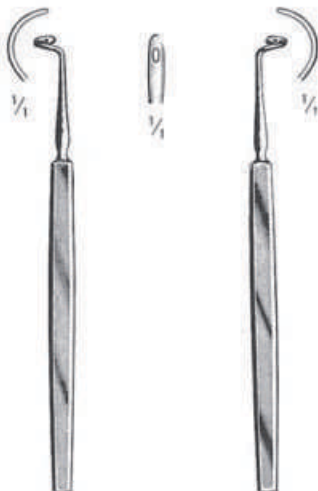

R	KRONECKER	L
STI-15-2920	13 cm	STI-15-2921

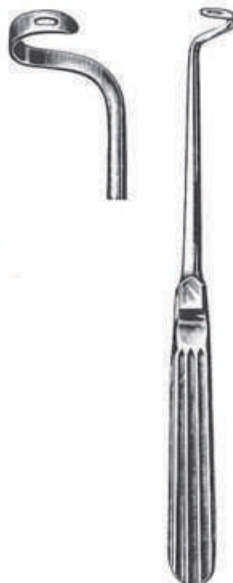

R	NELSON	L
STI-15-2922	24,5 cm	STI-15-2923

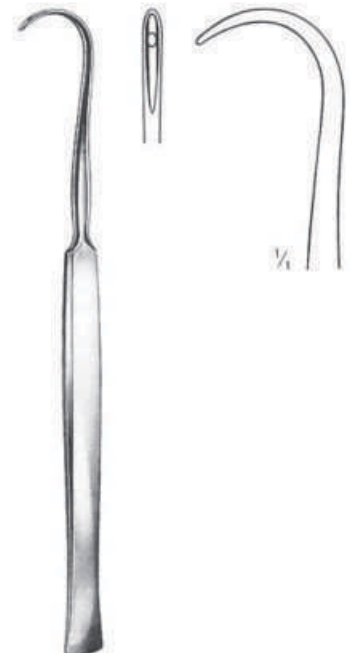

R	COOPER	L
EV-15-2924	19 cm	



REVERDIN	cm	Fig. 1	Fig. 2	Fig. 3	Fig. 4
EV-15-2925-2940	15	STI-15-2925	STI-15-2929	STI-15-2933	STI-15-2937
	19	STI-15-2926	STI-15-2930	STI-15-2934	STI-15-2938
	21	STI-15-2927	STI-15-2931	STI-15-2935	STI-15-2939
	23	STI-15-2928	STI-15-2932	STI-15-2936	STI-15-2940



YOUNG Boomerang
STI-15-2941
25 cm



Fig. 1
STI-15-2942



Fig. 2
STI-15-2943



Fig. 3
STI-15-2944

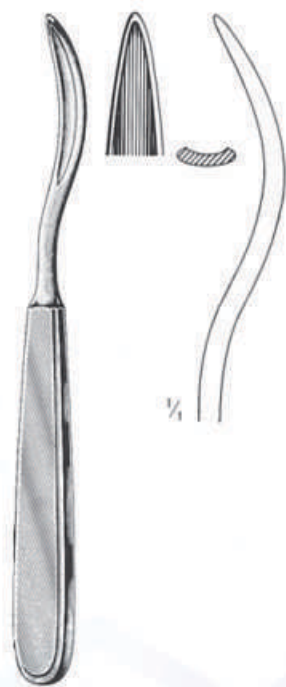

SCHMIEDEN
STI-15-2945
 19 cm



SCHMIEDEN-PAYR
STI-15-2946
 19 cm



BRUNNER
STI-15-2947
 30 cm

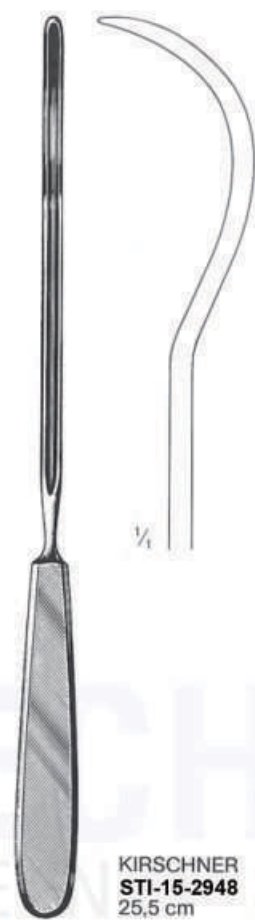

KIRSCHNER
STI-15-2948
 25,5 cm

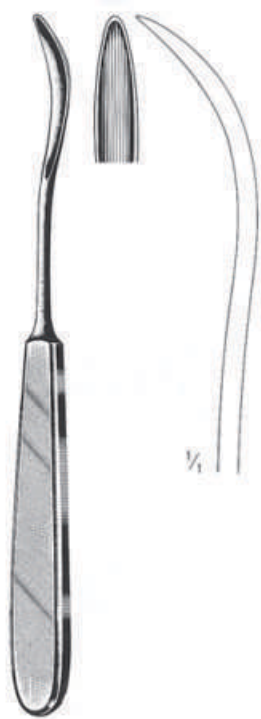

KOENIG
STI-15-2949
 20 cm



PAYR
STI-15-2950
 22 cm

PAYR
STI-15-2951
 22 cm



cm	BRUNNER
18	STI-15-2952
27	STI-15-2953

Plastik
 from plastic material
 matière plastique
 de materia plástica
 in plastica

In Packungen zu 1 Dutzend
in packages of 1 dozen
en enveloppes de 1 douzaine
en sobres de 1 dozana
bustine di 1 dozzina

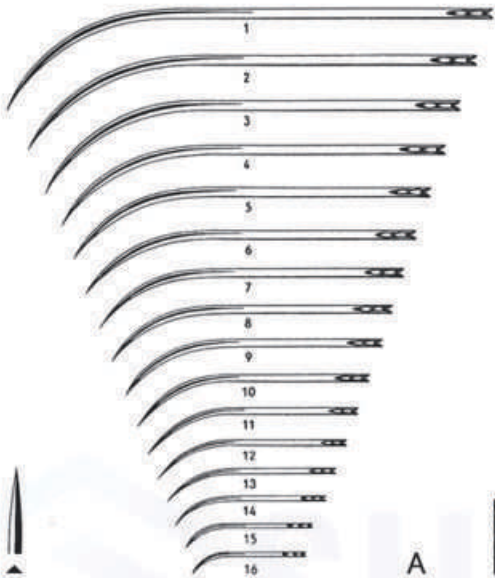

STI-15-2954-2969



STI-15-2970-2985



STI-15-2986-3002

Alle Nadeln mit Federöhr
all the needles with spring eye
toutes les aiguilles à chas à ressort
todas las agujas con ojo de resorte
tutti gli aghi con cruna aperta



STI-15-3003-3011

Fig.	1	2	3	4	5	6	7	8	9	10	11	12	13	14	15	16
A	STI-15-2954	STI-15-2955	STI-15-2956	STI-15-2957	STI-15-2958	STI-15-2959	STI-15-2960	STI-15-2961	STI-15-2962	STI-15-2963	STI-15-2964	STI-15-2965	STI-15-2966	STI-15-2967	STI-15-2968	STI-15-2969
B	STI-15-2970	STI-15-2971	STI-15-2972	STI-15-2973	STI-15-2974	STI-15-2975	STI-15-2976	STI-15-2977	STI-15-2978	STI-15-2979	STI-15-2980	STI-15-2981	STI-15-2982	STI-15-2983	STI-15-2984	STI-15-2985
G	STI-15-2986	STI-15-2987	STI-15-2988	STI-15-2989	STI-15-2990	STI-15-2991	STI-15-2992	STI-15-2993	STI-15-2994	STI-15-2995	STI-15-2996	STI-15-2997	STI-15-2998	STI-15-2999	STI-15-3001	STI-15-3002
Ga	STI-15-3003	STI-15-3004	STI-15-3005	STI-15-3006	STI-15-3007	STI-15-3008	STI-15-3009	STI-15-3010	STI-15-3011							



KOENIG
STI-15-3012-3022



KEITH
EV-15-3032-3038

Alle Nadeln mit Federöhr
all the needles with spring eye
toutes les aiguilles à chas à ressort
todas las agujas con ojo de resorte
tutti gli aghi con cruna aperta



STI-15-3023-3031



KEITH
STI-15-3039-3045



STI-15-3046-3053

Pb



STI-15-3054-3061

Pc

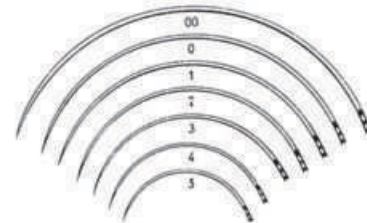

STI-15-3062-3069

Pd

Fig.	000	00	0	1	2	3	4	5	6	7	8	9	10	11	12
KOENIG				STI-15-3012	STI-15-30125	STI-15-30135	STI-15-30145	STI-15-30155	STI-15-30165	STI-15-30175	STI-15-30185	STI-15-30195	STI-15-30205	STI-15-30215	STI-15-3022
E	STI-15-3023	STI-15-30245	STI-15-30255	STI-15-30265	STI-15-30275	STI-15-30285	STI-15-30295	STI-15-30305	STI-15-3031						
KEITH				STI-15-3032	STI-15-30335	STI-15-30345	STI-15-30355	STI-15-30365	STI-15-30375	STI-15-3038					
KEITH				STI-15-3039	STI-15-30405	STI-15-30415	STI-15-30425	STI-15-30435	STI-15-30445	STI-15-3045					
Pb				STI-15-30465	STI-15-30475	STI-15-30485	STI-15-30495	STI-15-30505	STI-15-30515	STI-15-3052	STI-15-3053				
Pc				STI-15-30545	STI-15-30555	STI-15-30565	STI-15-30575	STI-15-30585	STI-15-30595	STI-15-3060	STI-15-3061				
Pd				STI-15-30625	STI-15-30635	STI-15-30645	STI-15-30655	STI-15-30665	STI-15-30675	STI-15-3068	STI-15-3069				



MICHEL
STI-15-3070
12 cm



WACHENFELDT
STI-15-3071
12,5 cm



WACHENFELDT
STI-15-3072
12,5 cm



HEGENBARTH
STI-15-3073
12,5 cm



CHILDE
STI-15-3074
18 cm



MICHEL
STI-15-3075
12 cm



MICHEL
STI-15-3076
13 cm

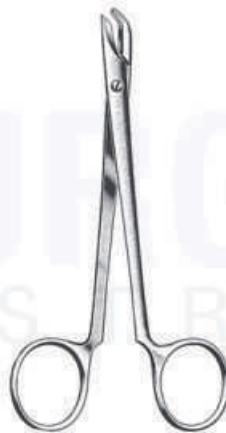

COLLIN
STI-15-3077
13 cm



RICHTER-HEATH
STI-15-3078
14 cm



MICHEL

	mm
STI-15-3079	7,5x1,75
STI-15-3080	11x2
STI-15-3081	12x3
STI-15-3082	14x3
STI-15-3083	16x3
STI-15-3084	18x3
STI-15-3085	20x3
STI-15-3086	22x3

Taschen-, Nahtbesteck
Pocket, Suturing Kits
Trousses à poche et à suture
Estuche de bolsillo y de sutura
Astucci tascabili e per sutura

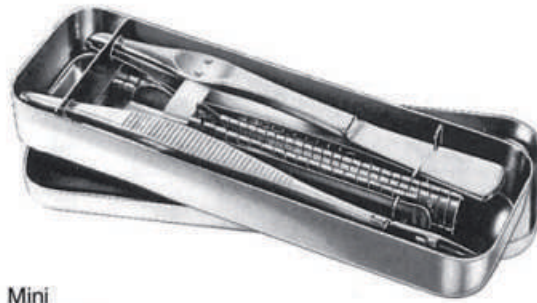

Mini
STI-15-3087
130x45x18 mm

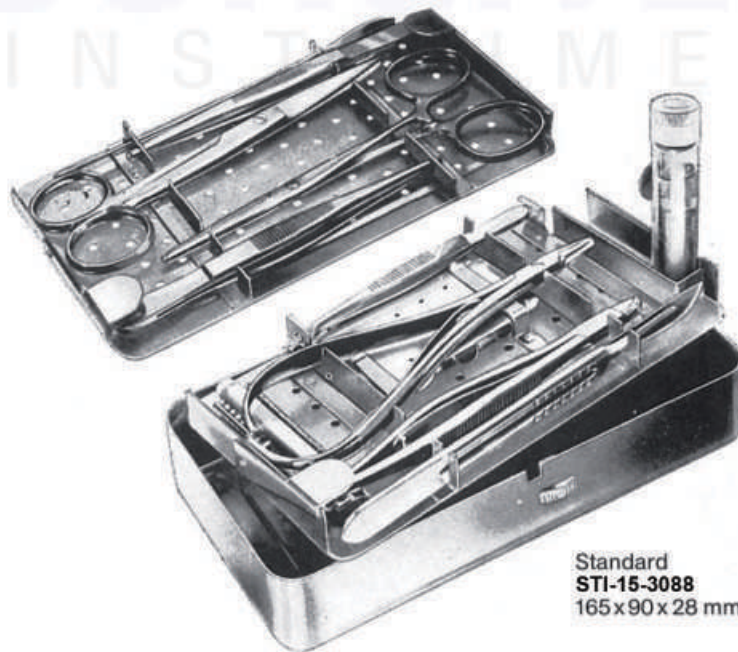

Standard
STI-15-3088
165x90x28 mm



Sterilizing Aids

Sterilisationsinstrumente
 Sterilization Instruments
 Instruments à stérilisation
 Instrumentos para la esterilización
 Strumenti per la sterilizzazione



cm	DAVIS
16	STI-16-3089
20	STI-16-3090
24	STI-16-3091



CHEATTLE
 STI-16-3092
 27 cm



Universal
 STI-16-3093 20 cm STI-16-3095
 STI-16-3094 28 cm STI-16-3096



ROGGE
 STI-16-3097
 23 cm



cm	
20	STI-16-3098
30	STI-16-3099



BUNT
 STI-16-4001
 12 cm

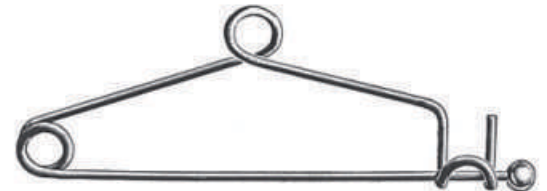

MAYO
 STI-16-4002
 14 cm



SAUERBRUCH
STI-16-4003
55 cm



DIMEDA
STI-16-4004
58 cm



STI-16-4004	215x 60x13mm
STI-16-4005	215x 65x15mm
STI-16-4006	215x 95x20mm
STI-16-4007	215x 95x25mm
STI-16-4008	215x100x28mm

STI-16-4009

Satz mit 5 Bürsten **STI-16-4004-4008**
set of 5 brushes **STI-16-4004-4008**
jeu de 5 brosses **STI-16-4004-4008**
juego de 5 cepillos **STI-16-4004-4008**
set a 5 spazzole **STI-16-4004-4008**



STI-16-4010	STI-16-4011	STI-16-4012	STI-16-4013	STI-16-4014	STI-16-4015	EV-16-4016
275x65x12mm	275x80x15mm	300x120x30mm	320x130x50mm	360x140x35mm	420x180x40mm	500x180x60mm

STI-16-4017
 490x180x80mm

STI-16-4018
 450x180x60mm

STI-16-4019
 420x130x75mm

STI-16-4020
 330x130x50mm

 konisch
 conical
 conique
 cónico
 conico

 konisch
 conical
 conique
 cónico
 conico

 konisch
 conical
 conique
 cónico
 conico

 konisch
 conical
 conique
 cónico
 conico

STI-16-4021
 400x190x8/20mm

STI-16-4022
 300x110x18/33mm

STI-16-4023
 320x70x15/25mm

STI-16-4024
 420x60x8/15mm

STI-16-4025
 1000x180x16mm

STI-16-4026
 210x95mm



Plaster of Paris

Gipsscheren
Plaster Shears
Ciseaux pour plâtre
Cizallas para yeso
Forbici per gesso



STILLE
STI-17-4027
24 cm



cm	STILLE
18,0	STI-17-4028
20,0	STI-17-4029
23,0	STI-17-4030
26,0	STI-17-4031
37,0	STI-17-4032



SEUTIN
STI-17-4033
23 cm

Gipssägen
Plaster Saws
Scies pour plâtre
Sierra para yeso
Seghe per gesso



WIGMORE
STI-17-4034
19 cm



ENGEL
STI-17-4035



BERGMANN
STI-17-4036

Gipspreizer
 Plaster Spreaders
 Ecarteur pour plâtre
 Separadores para yeso
 Divaricatori per gesso



HENNIG
STI-17-4037
 28 cm



HERMANN
STI-17-4038
 48 cm



QUATTRO
STI-17-4039
 23 cm



REFFSON
STI-17-4040
 30 cm



HAGLUND-STILLE
STI-17-4041
 28 cm



STI-17-4042
 23 cm

Gipsmesser
Plaster Knives
Couteaux pour plâtre
Cuchillos para yeso
Coltelli per gesso



HOPKINS
STI-17-4043
20 cm



ESMARCH
STI-17-4044
18 cm



REINER
STI-17-4045
18 cm



STI-17-4046
21 cm

Gipsabreißzangen
Plaster Breakers
Pince pour rompre plâtre
Pinzas para romper yeso
Pinze per rompere gesso



WOLFF
STI-17-4047
18 cm



WOLFF
STI-17-4048
24 cm



Bone Surgery, Osteosynthesis



FRIEDMAN Mini
STI-18-4049
 12 cm



FRIEDMAN
STI-18-4050
 14 cm



CLEVELAND
STI-18-4054
 17 cm Fig. 4 A



MEAD
STI-18-4055
 16,5 cm Fig. 1 A



FRIEDMAN
STI-18-4051
 14 cm



CLEVELAND
STI-18-4053
 14 cm Fig. 4

FRIEDMAN
STI-18-4052
 15 cm



MEAD
STI-18-4056
 16,5 cm



BLUMENTHAL
STI-18-4057
 15,5 cm



BLUMENTHAL
STI-18-4058
 15,5 cm

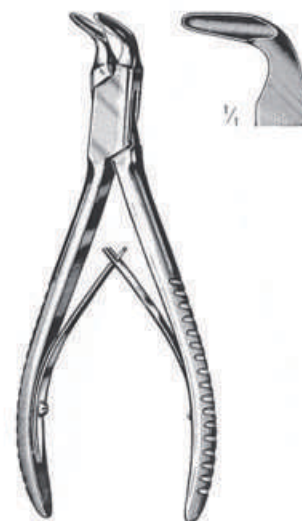

BLUMENTHAL
STI-18-4059
 15,5 cm



LUER
STI-18-4060
15 cm



LUER
STI-18-4061
15 cm

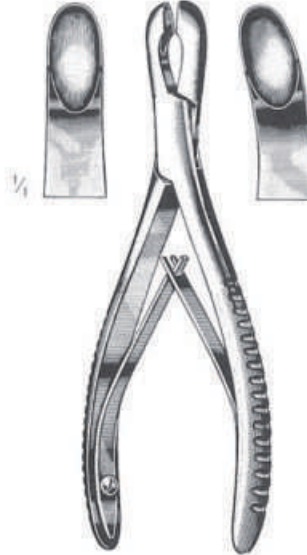

LUER
STI-18-4062 17 cm STI-18-4063



ADSON
STI-18-4064 20 cm STI-18-4065



OLIVECRONA
STI-18-4066
20 cm



LEMPERT
STI-18-4067 16 cm STI-18-4068



LEMPERT
STI-18-4069 8,5cm STI-18-4070



BEYER
STI-18-4071
 18 cm



ZAUFAL-JANSEN
STI-18-4072
 18 cm



BÖHLER

STI-18-4073 15 cm/2 mm **STI-18-4075** **STI-18-4077** 18 cm **STI-18-4078**
STI-18-4074 15 cm/3 mm **STI-18-4076**



RUSKIN



RUSKIN
STI-18-4079 23 cm **STI-18-4080**

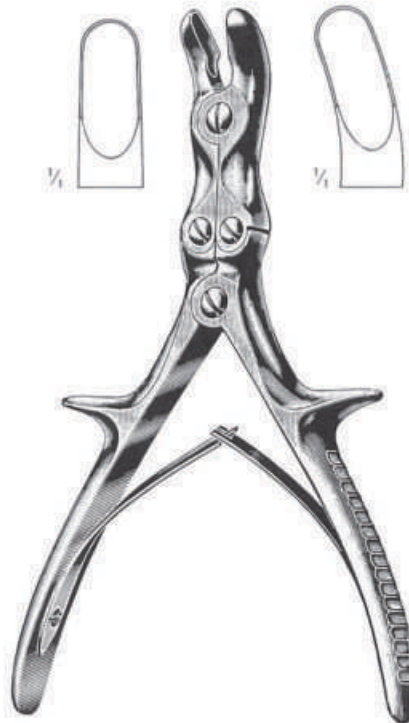

STILLE-LUER
 22 cm **STI-18-4082**
STI-18-4081 26 cm **STI-18-4083**

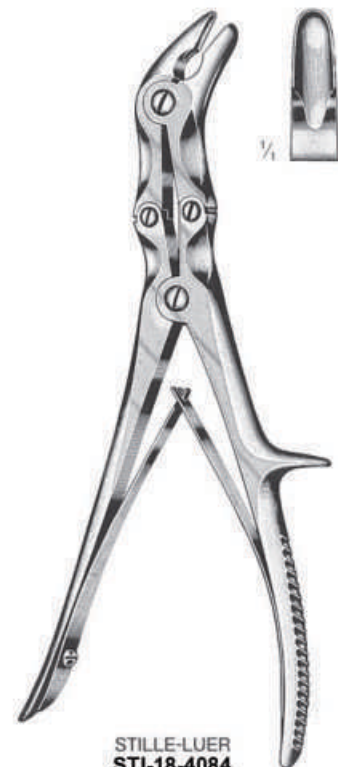

STILLE-LUER
STI-18-4084
 23 cm



Fig. SAUERBRUCH
1 **STI-18-4086**
2 **STI-18-4087**
30 cm

STILLE-RUSKIN
STI-18-4085
23 cm

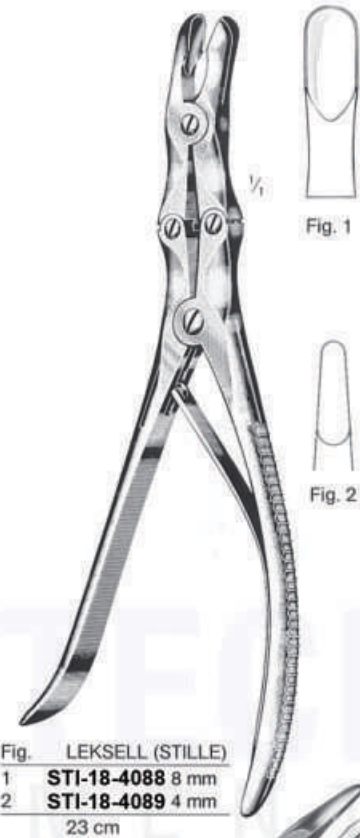

Fig. LEKSELL (STILLE)
1 **STI-18-4088** 8 mm
2 **STI-18-4089** 4 mm
23 cm



R SCAGLIETTI L
STI-18-4090 26 cm **STI-18-4091**
à droite à gauche
derecha izquierda
a destra a sinistra



FRYKHOLM
STI-18-4092
24 cm



mm ECHLIN
2 **STI-18-4093**
3 **STI-18-4094**
4 **STI-18-4095**
23 cm

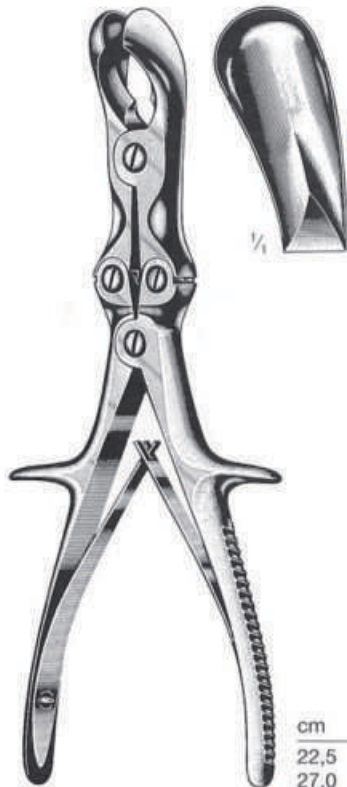

cm	SEMB
22,5	STI-18-4096
27,0	STI-18-4097

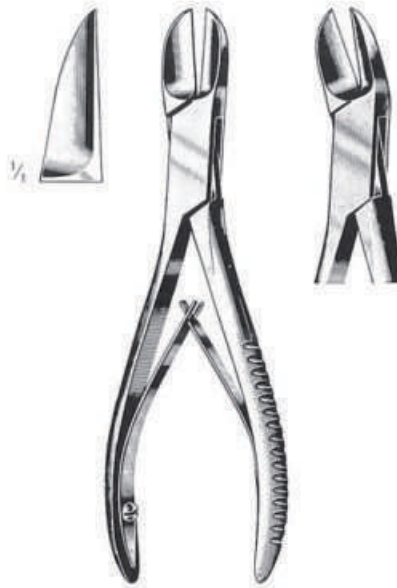

LISTON	
STI-18-4098	14 cm STI-18-5002
STI-18-4099	17 cm STI-18-5003
STI-18-5001	19 cm STI-18-5004
STI-18-5002	22 cm STI-18-5005



BÖHLER	
STI-18-5006	15 cm STI-18-5007



COTTLE-KAZANJIAN
STI-18-5008
 19 cm



RUSKIN-LISTON	
STI-18-5009	18,5cm STI-18-5010

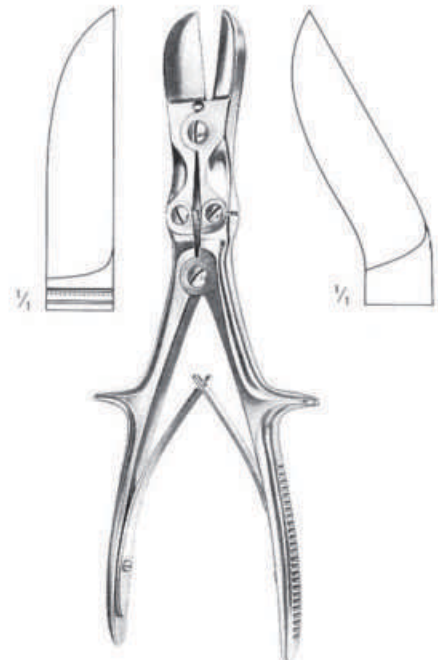

STILLE-LISTON	
STI-18-5011	27 cm STI-18-5012



STILLE-HORSLEY
STI-18-5013
27 cm

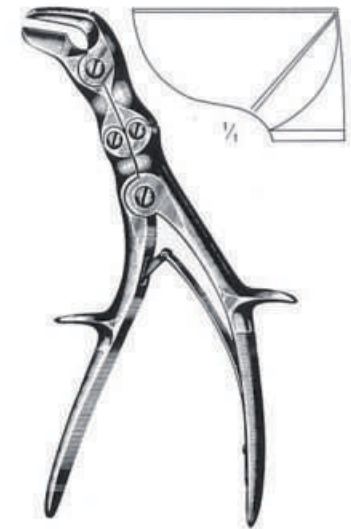

SEMB
STI-18-5014
24 cm

Knochenhalte-
zangen
Bone Holding
Forceps
Daviers porte-
os
Pinzas para
huesos
Tenaglie per
ossa

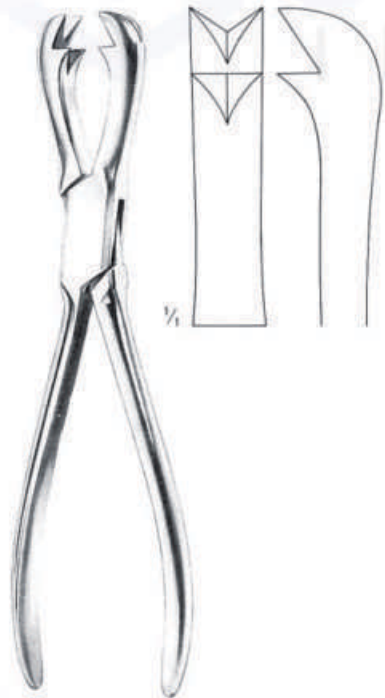

FERGUSSON
STI-18-5015
21 cm



LANGENBECK
STI-18-5016
21 cm

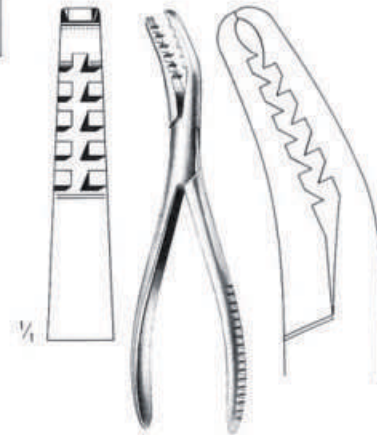

SEMB
STI-18-5017
19 cm



cm	FARABEU
23	STI-18-5018
26	STI-18-5019



FARABEU-F-LAMBOTTE
STI-18-5020
 26 cm



cm	LAMBOTTE
22	STI-18-5021
27	STI-18-5022
30	STI-18-5023



cm	LAMBOTTE
22	STI-18-5024
26	STI-18-5025
33	STI-18-5026



cm	LAMBOTTE
19	STI-18-5027
23	STI-18-5028
26	STI-18-5029

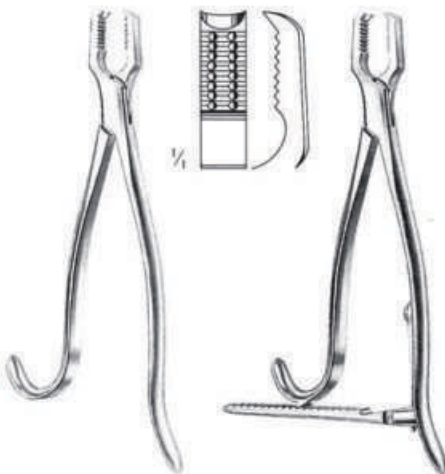

cm	KERN	KERN
15	STI-18-5030	STI-18-5033
17	STI-18-5031	STI-18-5034
21	STI-18-5032	STI-18-5035



cm	LANE
33	STI-18-5036
45	STI-18-5037

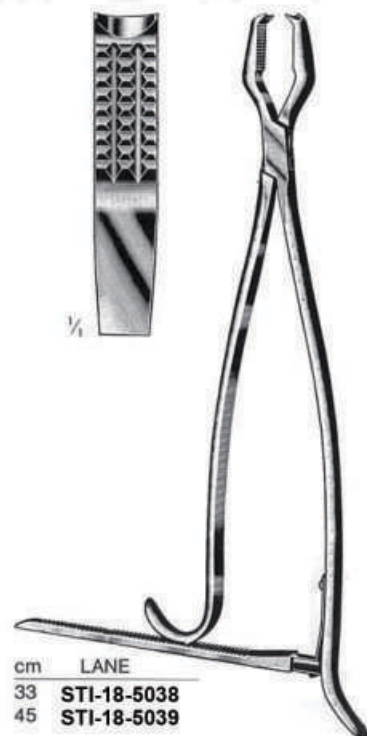

cm	LANE
33	STI-18-5038
45	STI-18-5039



STI-18-5040-5044

Selbstzentrierend
self-centering
autocentrant
autocentrantes
autocentranti



STI-18-5040
15 cm



STI-18-5041
19 cm



STI-18-5042
24 cm

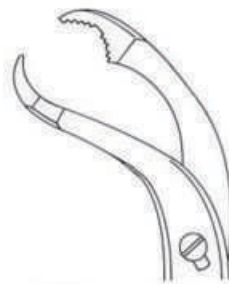

STI-18-5043
26 cm



STI-18-5044
28 cm

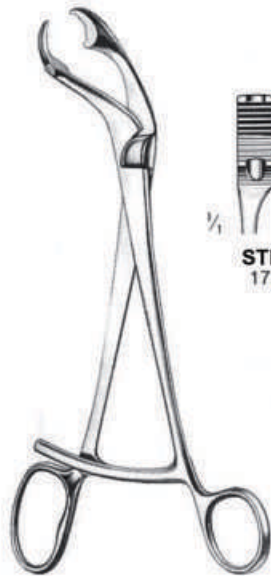

VERBRUGGE
STI-18-5045-5048



STI-18-5045
17,5 cm

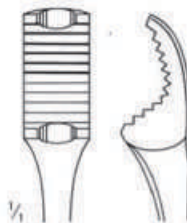

STI-18-5046
25 cm

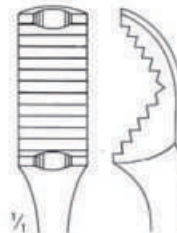

STI-18-5047
26 cm

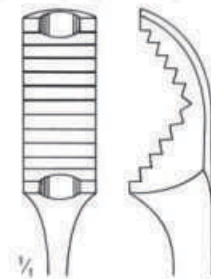

STI-18-5048
27 cm

Knochenhalte-, Sequesterzangen
 Bone Holding, Sequester Forceps
 Pinces à os, à séquestres
 Pinzas para huesos y secuestros
 Pinze per ossa e sequestri

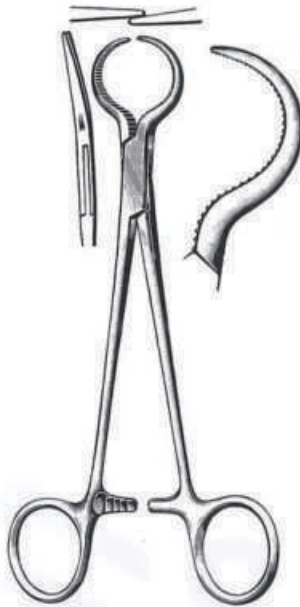

LEWIN
 STI-18-5049
 17,5 cm

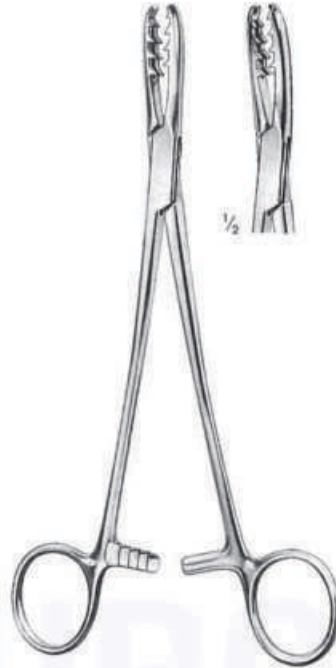

BIRCHER-GANSKE
 STI-18-5050 20 cm STI-18-5051

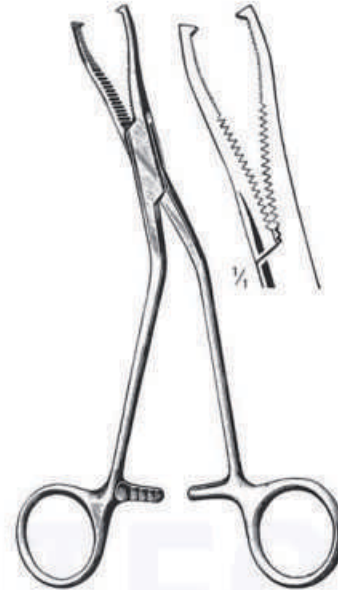

DINGMANN
 STI-18-5052
 19 cm



STI-18-5053
 13,5 cm



MARTIN
 STI-18-5054
 19 cm

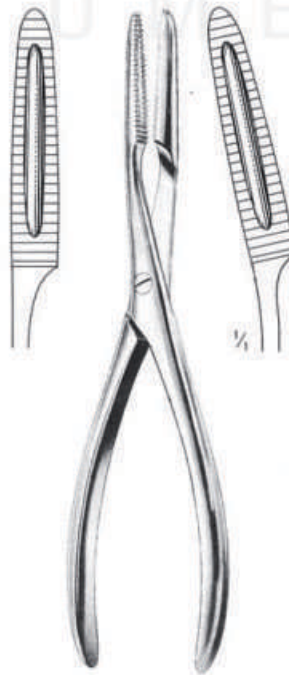

STI-18-5055 20 cm STI-18-5056



VAN BUREN
 STI-18-5057
 23 cm



cm	LOWMAN
13	STI-18-5058
18,5	STI-18-5059
20	STI-18-5060

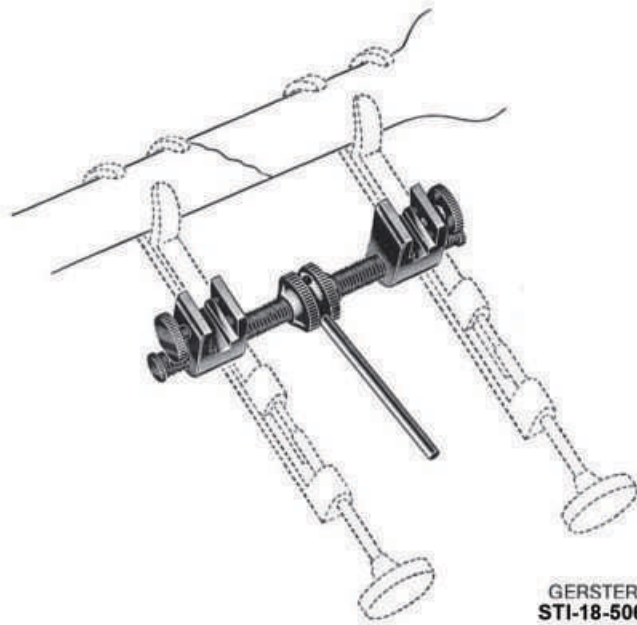

GERSTER
STI-18-5061



PARHAM
STI-18-5062



cm	PARHAM
18	STI-18-5063
30	STI-18-5064



STI-18-5065 f. Erwachsene
adult size
p. adultes
p. adultos
p. adulti
STI-18-5066 f. Kinder
child size
p. enfants
p. niños
p. bambini

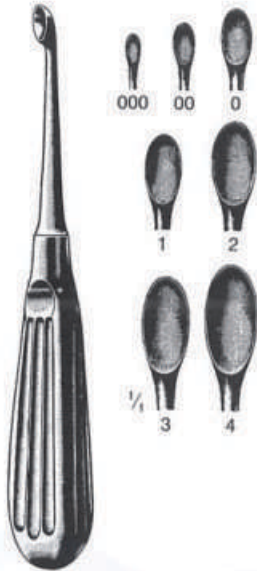

SCHIEDER
 STI-18-5067-5073

SCHIEDER	Fig.	VOLKMANN
	0000	STI-18-5074
STI-18-5067	000	STI-18-5075
STI-18-5068	00	STI-18-5076
STI-18-5069	0	STI-18-5077
STI-18-5070	1	STI-18-5078
STI-18-5071	2	STI-18-5079
STI-18-5072	3	STI-18-5080
STI-18-5073	4	STI-18-5081
	5	STI-18-5082
	6	STI-18-5083



VOLKMANN
 STI-18-5074-5083



BRUNS
 STI-18-5084-5093

BRUNS	Fig.	SPRATT
STI-18-5084	0000	STI-18-5094
STI-18-5085	000	STI-18-5095
STI-18-5086	00	STI-18-5096
STI-18-5087	0	STI-18-5097
STI-18-5088	1	STI-18-5098
STI-18-5089	2	STI-18-5099
STI-18-5090	3	STI-18-6001
STI-18-5091	4	STI-18-6002
STI-18-5092	5	STI-18-6003
STI-18-5093	6	STI-18-6004

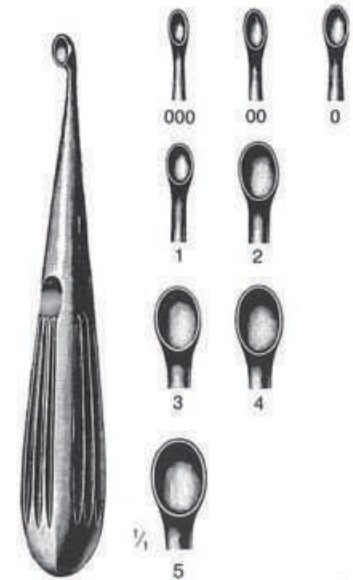

SPRATT
 STI-18-5094-6004

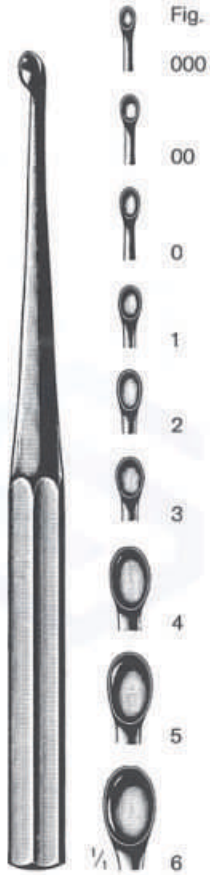

Fig.	BRUNS 23 cm	SIMON 24 cm
000	STI-18-6004	
00	STI-18-6005	
0	STI-18-6006	
1	STI-18-6007	STI-18-6013
2	STI-18-6008	STI-18-6014
3	STI-18-6009	STI-18-6015
4	STI-18-6010	STI-18-6016
5	STI-18-6011	STI-18-6017
6	STI-18-6012	STI-18-6018

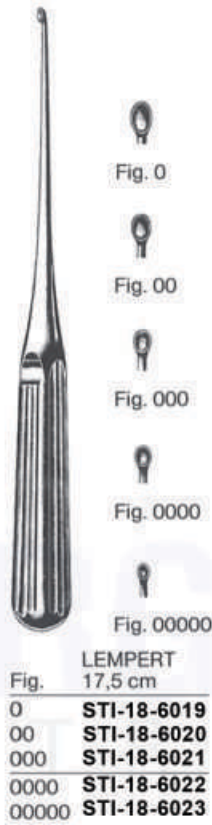
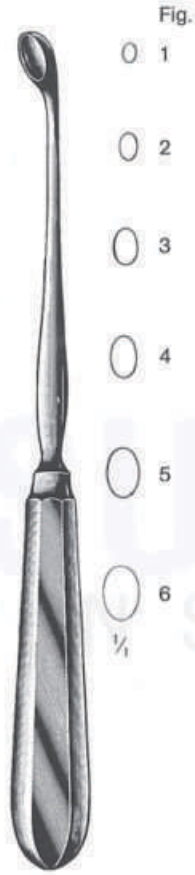

Fig.	LEMPERT 17,5 cm
0	STI-18-6019
00	STI-18-6020
000	STI-18-6021
0000	STI-18-6022
00000	STI-18-6023

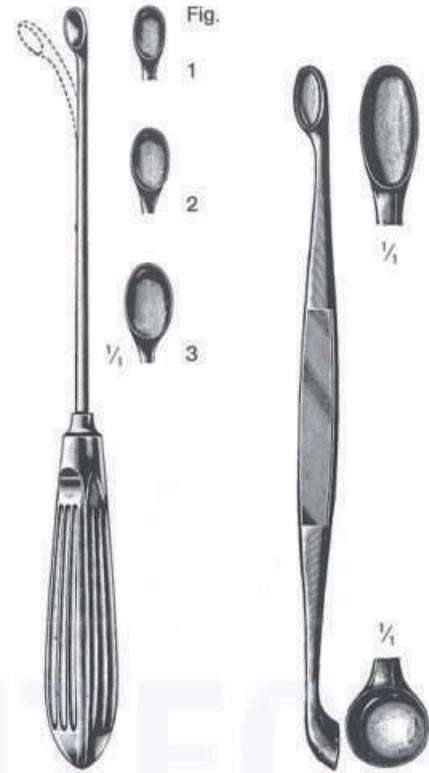

Fig.	HALLE 21 cm	cm	VOLKMANN
1	STI-18-6024	13	STI-18-6027
2	STI-18-6025	16	STI-18-6028
3	STI-18-6026	20	STI-18-6029



cm	VOLKMANN
13	STI-18-6030
14	STI-18-6031
17	STI-18-6032

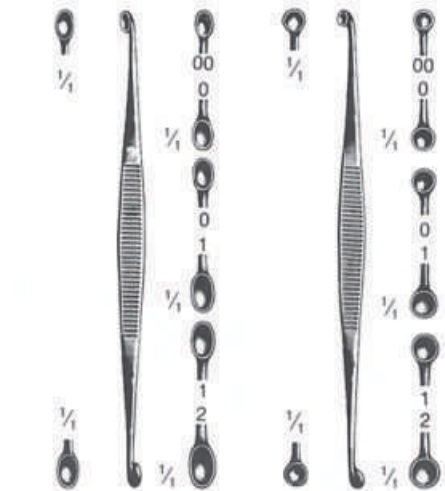

Fig.	WILLIGER 13,5 cm	MARTINI 13,5 cm
00/0	STI-18-6033	STI-18-6036
0/1	STI-18-6034	STI-18-6037
1/2	STI-18-6035	STI-18-6038



mm	13,5 cm	13,5 cm	13,5 cm
4	STI-18-6039	STI-18-6045	STI-18-6052
6		STI-18-6046	
8	STI-18-6040	STI-18-6047	STI-18-6053
10	STI-18-6041	STI-18-6048	STI-18-6054
12	STI-18-6042	STI-18-6049	STI-18-6055
14	STI-18-6043	STI-18-6050	STI-18-6056
16	STI-18-6044	STI-18-6051	STI-18-6057



	ALEXANDER 17 cm	ALEXANDER 17 cm
	STI-18-6058	STI-18-6064
	STI-18-6059	STI-18-6065
	STI-18-6060	STI-18-6066
	STI-18-6061	STI-18-6067
	STI-18-6062	STI-18-6068
	STI-18-6063	STI-18-6069



mm	PARTSCH		PARTSCH	
	13,5 cm	17 cm	13,5 cm	17 cm
2	STI-18-6070	STI-18-6077	STI-18-6084	STI-18-6091
3	STI-18-6071	STI-18-6078	STI-18-6085	STI-18-6092
4	STI-18-6072	STI-18-6079	STI-18-6086	STI-18-6093
5	STI-18-6073	STI-18-6080	STI-18-6087	STI-18-6094
6	STI-18-6074	STI-18-6081	STI-18-6088	STI-18-6095
7	STI-18-6075	STI-18-6082	STI-18-6089	STI-18-6096
8	STI-18-6076	STI-18-6083	STI-18-6090	STI-18-6097

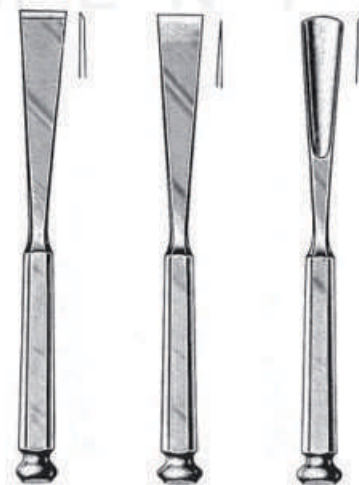

mm	STILLE		
	20 cm	20 cm	20 cm
10	STI-18-6098	STI-18-6103	STI-18-6107
15	STI-18-6099	STI-18-6104	STI-18-6108
20	STI-18-6101	STI-18-6105	STI-18-6109
25	STI-18-6102	STI-18-6106	STI-18-6110



SMITH-PETERSEN					LAMBOTTE		LAMBOTTE mini		
mm					mm				
6	STI-18-6111	STI-18-6118	STI-18-6125	STI-18-6131	6,5	STI-18-6138	STI-18-6145	3	STI-18-6152
9	STI-18-6112	STI-18-6119	STI-18-6126	STI-18-6132	15,0	STI-18-6139	STI-18-6146	4	STI-18-6153
13	STI-18-6113	STI-18-6120	STI-18-6127	STI-18-6133	20,0	STI-18-6140	STI-18-6147	6	STI-18-6154
16	STI-18-6114	STI-18-6121	STI-18-6128	STI-18-6134	25,0	STI-18-6141	STI-18-6148	8	STI-18-6155
19	STI-18-6115	STI-18-6122	STI-18-6129	STI-18-6135	30,0	STI-18-6142	STI-18-6149	10	STI-18-6156
25	STI-18-6116	STI-18-6123	STI-18-6130	STI-18-6136	38,0	STI-18-6143	STI-18-6150	12	STI-18-6157
32	STI-18-6117	STI-18-6124	STI-18-6130	STI-18-6137	44,0	STI-18-6144	STI-18-6151	15	STI-18-6158
	20 cm	20 cm	20 cm	20 cm		24 cm	23 cm		12,5 cm



mm	LEXER	LEXER
7	STI-18-6159	STI-18-6165
10	STI-18-6160	STI-18-6166
15	STI-18-6161	STI-18-6167
20	STI-18-6162	STI-18-6168
25	STI-18-6163	STI-18-6169
30	STI-18-6164	STI-18-6170
	22 cm	22 cm

mm	LEXER mini	LEXER mini
4	STI-18-6171	STI-18-6176
6	STI-18-6172	STI-18-6177
8	STI-18-6173	STI-18-6178
10	STI-18-6174	STI-18-6179
12	STI-18-6175	STI-18-6180

I N S T R U M E N T S



mm	HOKE
3	STI-18-6181
5	STI-18-6182
6	STI-18-6183
8	STI-18-6184
9	STI-18-6185
	17 cm

mm	HIBBS					
6	STI-18-6186	STI-18-6191	STI-18-6196	STI-18-6202	STI-18-6207	STI-18-6208
13	STI-18-6187	STI-18-6192	STI-18-6197	STI-18-6203	STI-18-6208	STI-18-6209
19	STI-18-6188	STI-18-6193	STI-18-6198	STI-18-6204	STI-18-6209	STI-18-6210
25	STI-18-6189	STI-18-6194	STI-18-6199	STI-18-6205	STI-18-6210	STI-18-6211
32	STI-18-6190	STI-18-6195	STI-18-6201	STI-18-6206	STI-18-6211	STI-18-6211
	24 cm	24 cm	24 cm	24 cm	24 cm	24 cm



LEBSCHE
STI-18-6212
24,5 cm



STI-18-6213
22 cm



VIRCHOW
STI-18-6214



BRUNETTI
STI-18-6215
28 cm



BRUNETTI
STI-18-6216
28 cm

Autopsie-Besteck
Post Mortem Set
Set à autopsie
Juego de autopsia
Set per autopsia



STI-18-6217



GERZOG
STI-18-6218
 18 cm 250 g

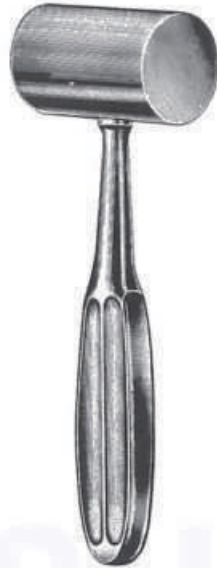

KIRK
STI-18-6219
 19 cm 750 g



g
 450
 900
STI-18-6220
STI-18-6221
 26,5 cm



COLLIN
STI-18-6222
 20 cm 220 g



WILLIGER
STI-18-6223
 24 cm 340 g

32.697.02
 Paar Ersatzbacken
 Pair of Spare Faces
 Paire de faces de rechange
 Pareja de tapas intercambiables
 Coppia di teste di ricambio



LUCAE
STI-18-6224
 19 cm 260 g



MEAD
STI-18-6225
 17 cm 320 g



g
 250
 400
STI-18-6226
STI-18-6227
 26 cm



QUISLING
STI-18-6228



STI-18-6229
 23,5 cm

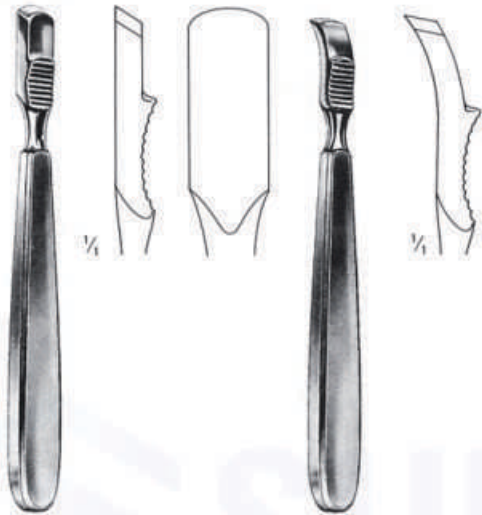

FARABEUF
STI-18-6230
15 cm

FARABEUF
STI-18-6231
15 cm



mm	LAMBOTTE
10	STI-18-6232
15	STI-18-6233
20	STI-18-6234
25	STI-18-6235
	21 cm

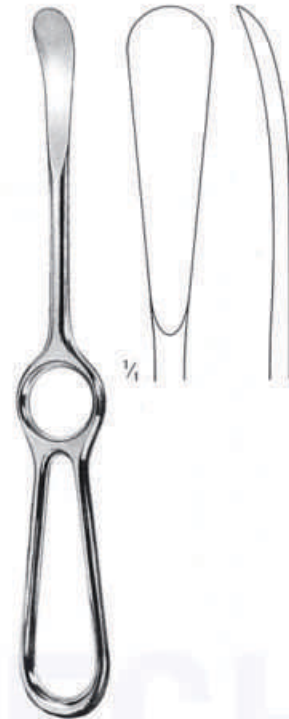

SEDILLOT
STI-18-6236
21 cm

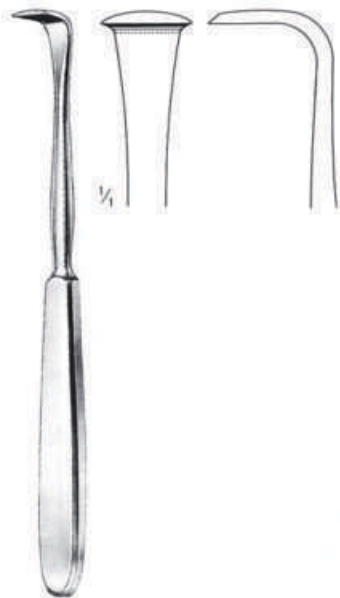

LANGENBECK
STI-18-6237
18 cm



WILLIGER
STI-18-6238
16 cm

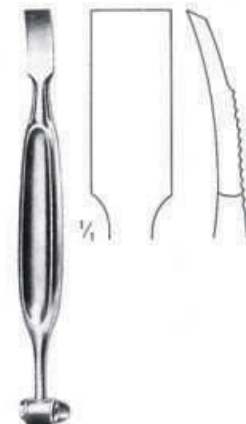

cm	ALEXANDER
16	STI-18-6239
20	STI-18-6240

Für Rippen
 Rib
 Pour les côtes
 Para costillas
 Costali



DOYEN DOYEN
 STI-18-6241-6244
 17 cm

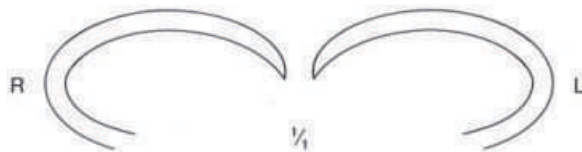

STI-18-6241 STI-18-6242

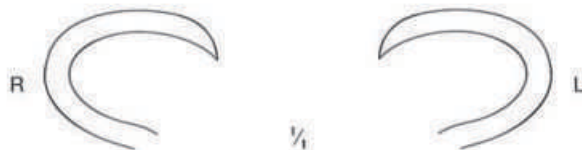

STI-18-6243 STI-18-6244

SURGITECH
 INSTRUMENTS



SEMB
 STI-18-6245-6251



STI-18-6245
 17,5 cm



STI-18-6246
 21,0 cm



STI-18-6247
 17,5 cm



STI-18-6248
 21,0 cm



STI-18-6249
 20,5 cm



STI-18-6250
 20,5 cm



STI-18-6251
 22,5 cm



MATSON
STI-18-6252
22 cm



OVERHOLT
STI-18-6253
29,5 cm



OVERHOLT
STI-18-6254
29,5 cm



OVERHOLT
STI-18-6255
28,5 cm



LANGENBECK
STI-18-6256
20 cm



LANGENBECK
STI-18-6257
20 cm



ADSON
STI-18-6258-6261
17 cm



KEY
STI-18-6262-6264
19 cm

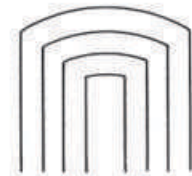

mm	
6	STI-18-6262
12	STI-18-6263
19	STI-18-6264
25	32.759.25



WATSON-CHEYNE
STI-18-6265
 17,5 cm



McDONALD
STI-18-6266
 19 cm



MURPHY-LANE
STI-18-6267
 30 cm



BENNETT
STI-18-6268
 65 x 260 mm



BENNETT
STI-18-6269
 45 x 260 mm



HOHMANN
STI-18-6270
 8 mm



HOHMANN
STI-18-6271
 18 mm



HOHMANN
STI-18-6272
 43 mm



HOHMANN
STI-18-6273
 70 mm



Knochenhebel
 Bone Levers
 Leviers à os
 Elevadores para huesos
 Elevatori per ossa



BLOUNT
STI-18-6282
 26 cm



BLOUNT
STI-18-6283
 26 cm

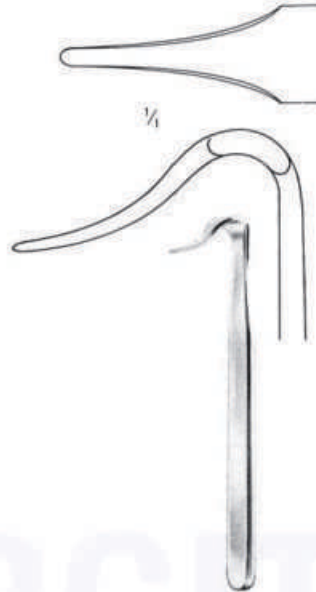

BLOUNT
STI-18-6284
 17,5 cm



mm x mm	TAYLOR
75 x 30	STI-18-6285
100 x 30	STI-18-6286
	16,5 cm

Meniskotome · Meniscotomes
 Meniscotomes · Meniscótomos
 Meniscotomi



SMILLIE
STI-18-6287
 17 cm



STI-18-6288
 17 cm



STI-18-6289
 17 cm



BIRCHER
STI-18-6290
 19 cm



BIRCHER
STI-18-6291
 19 cm



NEFF
STI-18-6292 22 cm **STI-18-6293**

Sehnenstripper, Knochenfeilen
Tendon Strippers, Bone Files
Instruments a écorcher les tendons, limes à os
Separadores para tendones, limas para huesos
Scollatendini, lime per ossa



- STI-18-6294
- STI-18-6295
- STI-18-6296
- STI-18-6297
- ¼ ○
STI-18-6298

BUNNELL
STI-18-6294-98
15 cm



STI-18-6299
24,5 cm



STI-18-6301
22 cm



PUTTI
STI-18-6302
27 cm



PUTTI
STI-18-6303
30 cm

Amputation, Finger
 Amputation, Fingers
 Amputation, doigts
 Amputación, dedos
 Amputazione, dita

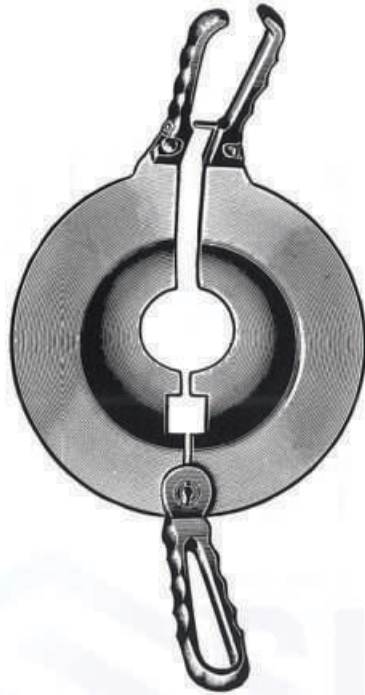

PERCY
 STI-18-6304

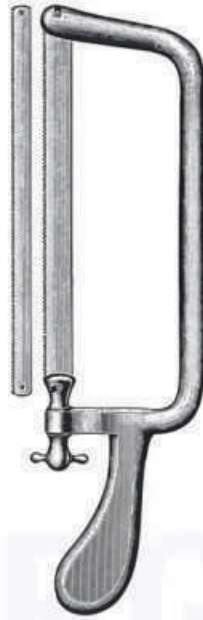

CHARRIERE
 STI-18-6305



CHARRIERE
 STI-18-6306
 30 cm



SATTERLEE
 STI-18-6307
 31 cm



LANGENBECK
 STI-18-6308
 23 cm



STI-18-6309
 Compl. incl.
 STI-18-6310

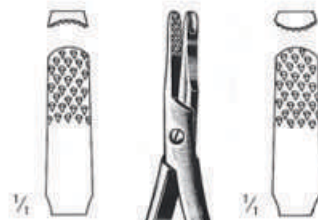

RADOLF
 STI-18-6311
 13,5 cm



STI-18-6312

DIMEDA
 STI-18-6313
 17 cm



STI-18-6315

STI-18-6314

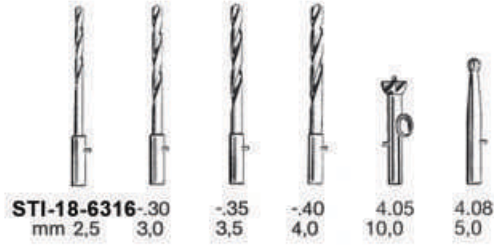
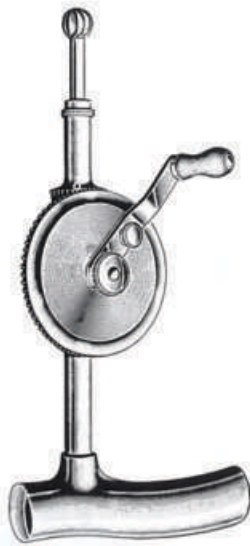

STILLE
STI-18-6318
Compl. 20 cm



STILLE-SHERMAN
STI-18-6319
Compl. 24 cm

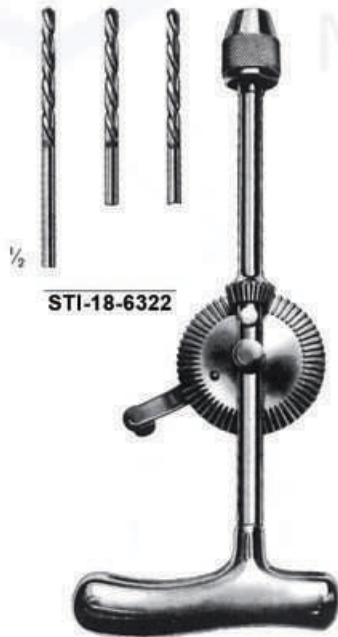

STI-18-6322

MOORE
STI-18-6321
Compl. 28 cm



HUDSON
STI-18-6322
Compl. incl. STI-18-6323-29
27 cm



CUSHING
STI-18-6327



STI-18-6328



MCKENZIE
STI-18-6329



KIRSCHNER
STI-18-6330
Compl.



STI-18-6331



STI-18-6333
Compl.



STI-18-6332



BUNNELL
STI-18-6334
16 cm



RALK
STI-18-6335

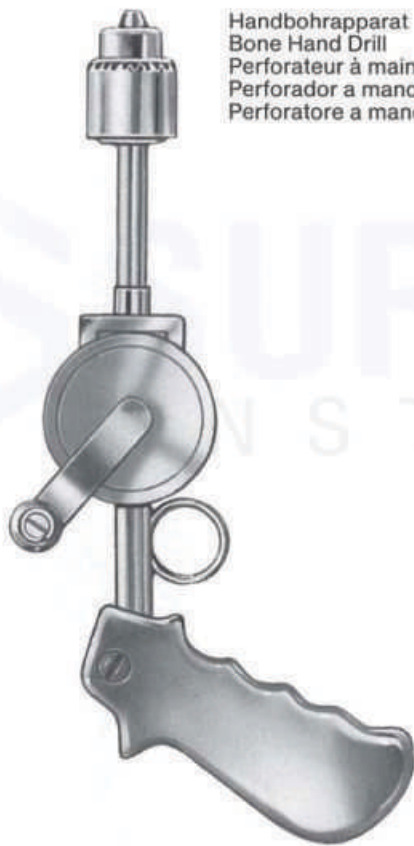

Handbohrapparat
Bone Hand Drill
Perforateur à main
Perforador a mano
Perforatore a mano

STI-18-6336



STI-18-6337



mm			
1,0		STI-18-6347	STI-18-6360
1,2		STI-18-6348	
1,5		STI-18-6349	STI-18-6361
1,8		STI-18-6350	
2,0	STI-18-6338	STI-18-6351	STI-18-6362
2,2		STI-18-6352	
2,5	STI-18-6339	STI-18-6353	STI-18-6363
2,8		STI-18-6354	STI-18-6364
3,0	STI-18-6340	STI-18-6355	STI-18-6365
3,2	STI-18-6341	STI-18-6356	STI-18-6366
3,5	STI-18-6342	STI-18-6357	STI-18-6367
4,0	STI-18-6343	STI-18-6358	STI-18-6368
5,0	STI-18-6344	STI-18-6359	STI-18-6369
6,0	STI-18-6345		STI-18-6370
7,0	STI-18-6346		



mm Ø	DOYEN	DOYEN	DOYEN	DOYEN	ALBEE	ALBEE	BORCHARDT	TOTI
4	STI-18-6371	STI-18-6378						
6	STI-18-6372	STI-18-6379						
7							STI-18-6393	
8	STI-18-6373	STI-18-6380		STI-18-6386		STI-18-6390		STI-18-6396
10	STI-18-6374	STI-18-6381		STI-18-6387		STI-18-6391		
12	STI-18-6375	STI-18-6382	STI-18-6385		STI-18-6388	STI-18-6392		
13							STI-18-6394	
14	STI-18-6376	STI-18-6383						
15					STI-18-6389			
16	STI-18-6377	STI-18-6384						
25								STI-18-6395

Reibahlen
Reamer
Pointes-carrées
Escariadores
Punteruoli

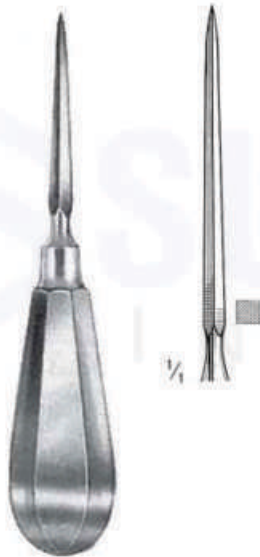

EV-18-6397
14 cm

1/4



PERTHES
EV-18-6398
21 cm

lieferbar in Packungen à 10 Stück
available in packages with 10 pieces
disponibles en paquets de 10 pièces
disponible en paquetes de 10 unidades
disponibili in confezioni da pezzi



Trokarspitze
Trocar tip
Pointe trocar
Punta en forma de trócar
Punte a trequarti

mm Ø	L = 60 mm	L = 120 mm	L = 140 mm	L = 160 mm	L = 310 mm
1,0	STI-18-6399	STI-18-6408	STI-18-6416	STI-18-6424	STI-18-6433
1,2	STI-18-6401	STI-18-6409	STI-18-6417	STI-18-6425	STI-18-6434
1,4	STI-18-6402	STI-18-6410	STI-18-6418	STI-18-6426	STI-18-6435
1,5	STI-18-6403	STI-18-6411	STI-18-6419	STI-18-6427	STI-18-6436
1,6	STI-18-6404	STI-18-6412	STI-18-6420	STI-18-6428	STI-18-6437
1,8	STI-18-6405	STI-18-6413	STI-18-6421	STI-18-6429	STI-18-6438
2,0	STI-18-6406	STI-18-6414	STI-18-6422	STI-18-6430	STI-18-6439
2,2	STI-18-6407	STI-18-6415	STI-18-6423	STI-18-6431	STI-18-6440
2,5				STI-18-6432	STI-18-6441

KIRSCHNER
EV-18-6399-6441

lieferbar in Packungen à 10 Stück
available in packages with 10 pieces
disponibles en paquets de 10 pièces
disponible en paquetes de 10 unidades
disponibili in confezioni da pezzi



Lanzenspitze
Lancet tip
Pointe lancéolaire
Punta lanceolar
Punte lanceolari

mm Ø	L = 310 mm
1,0	STI-18-6442
1,2	STI-18-6445
1,5	STI-18-6446
1,6	STI-18-6447
1,8	STI-18-6448
2,0	STI-18-6449
2,2	STI-18-6450
2,5	STI-18-6451

KIRSCHNER
EV-18-6442-6451

STEINMANN Nägel
STEINMANN Pins
STEINMANN clous à os
STEINMANN clavos p. huesos
STEINMANN chiodi per ossa



L cm	
13	STI-18-6452
14	STI-18-6453
15	STI-18-6454
16	STI-18-6455
18	STI-18-6456
20	STI-18-6457
21	STI-18-6458

STEINMANN
EV-18-6452-6458

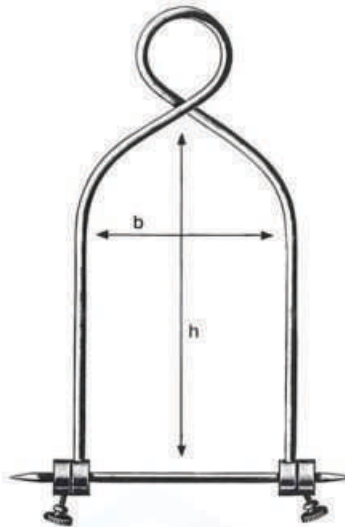

h x b cm	BOEHLER
16 x 9	STI-18-6459
16 x 11	STI-18-6460

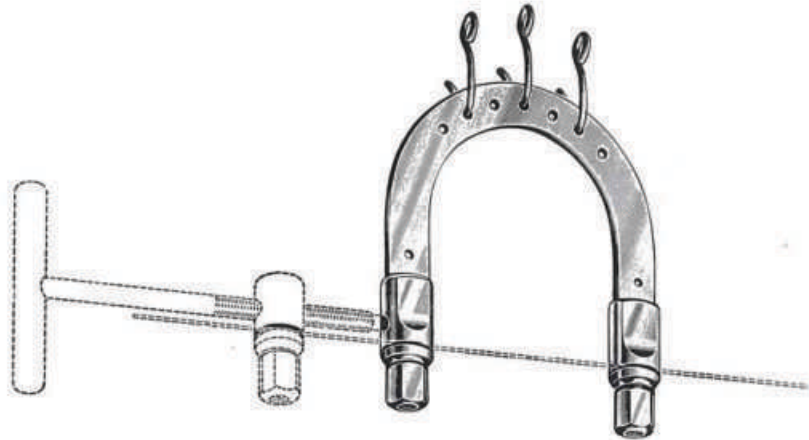

h x b cm	KIRSCHNER
6,0 x 5,0	STI-18-6461
9,5 x 7,0	STI-18-6462
10,5 x 10,5	STI-18-6463
9,5 x 11,0	STI-18-6464
12,0 x 12,0	STI-18-6465
13,5 x 13,0	STI-18-6466
15,5 x 15,5	STI-18-6467
20,0 x 15,5	STI-18-6468



h x b cm	KIRSCHNER U.S.
18 x 10	STI-18-6469
27 x 16	STI-18-6470



STI-18-6471



STI-18-6472

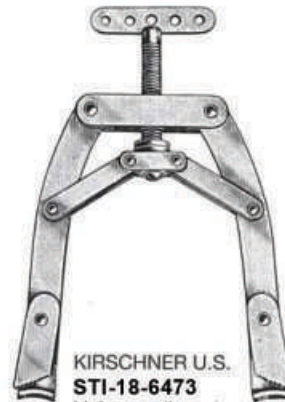

KIRSCHNER U.S.
STI-18-6473
klein · small · petit
pequeño · piccolo
STI-18-6474
groß · large size
grand · grande
STI-18-6475
extra groß · extra large size
extra grand · extra grande



STI-18-6476



STI-18-6477



10 mm

weich
 soft
 souple
 blando
 morbido

mm Ø

0,2	STI-18-6478
0,3	STI-18-6479
0,4	STI-18-6480
0,5	STI-18-6481
0,6	STI-18-6482
0,7	STI-18-6483
0,8	STI-18-6484
0,9	STI-18-6485
1,0	STI-18-6486
1,1	STI-18-6487
1,2	STI-18-6488
1,5	STI-18-6489



LOUTE
STI-18-6490
 21 cm



STI-18-6491
 17 cm

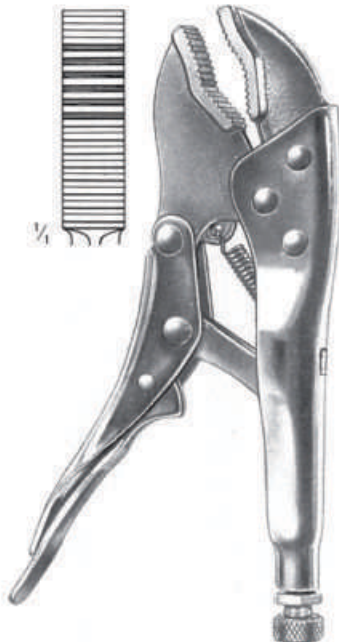

Grip
STI-18-6492
 18 cm



STI-18-6493
 15 cm



STI-18-6494
 14 cm

Mit TC-Einsätzen
TC Lined
A mors TC
Con bocas TC
Con morso TC



STI-18-6495
16 cm



STI-18-6496
15 cm



STI-18-6497
22 cm



mm Ø	
2,4	STI-18-6498
3,2	STI-18-6499
4,8	STI-18-6501
6,4	STI-18-6502



	STI-18-6503	STI-18-6504	STI-18-6505	STI-18-6506
f./p. Ø	2,4 mm	3,2 mm	4,8 mm	6,4 mm



KUENTSCHER
STI-18-6507
 26 cm



KUENTSCHER
STI-18-6508
 35 cm



STI-18-6509
STI-18-6510

mm Ø	L = 35 cm	L = 46 cm	L = 60 cm
2,5	STI-18-6511	STI-18-6516	
3,0	STI-18-6512	STI-18-6517	
3,5	STI-18-6513	STI-18-6518	STI-18-6521
4,0	STI-18-6514	STI-18-6519	STI-18-6522
5,0	STI-18-6515	STI-18-6520	STI-18-6523



KUENTSCHER
STI-18-6524
 21 cm



KUENTSCHER
STI-18-6525
 21 cm



STI-18-6526 **STI-18-6527**



STI-18-6528 **STI-18-6529**



KUENTSCHER
STI-18-6530
 63 cm



cm	
29	STI-18-6531
37	STI-18-6532
42	STI-18-6533
49	STI-18-6534



STI-18-6535



LLOYD
STI-18-6536
20 cm



LANE
STI-18-6537
25 cm



WILLIAMS
STI-18-6538
24 cm



mm
2,5 STI-18-6539
3,5 STI-18-6540



LANE
STI-18-6541
25 cm



LANE
STI-18-6542
18 cm



LANE
STI-18-6543
23 cm



LANE
STI-18-6544
22 cm



LANE
STI-18-6545
18 cm

Instrumentarium zum Einbringen von Hohlschrauben
 Instrument Set for Cannulated Screws
 Instrumentation pour l'application des vis à perforation longitudinale
 Instrumental para la aplicación de tornillos de perforación longitudinal
 Strumentario per viti cannulate



Neurosurgery, Laminectomy



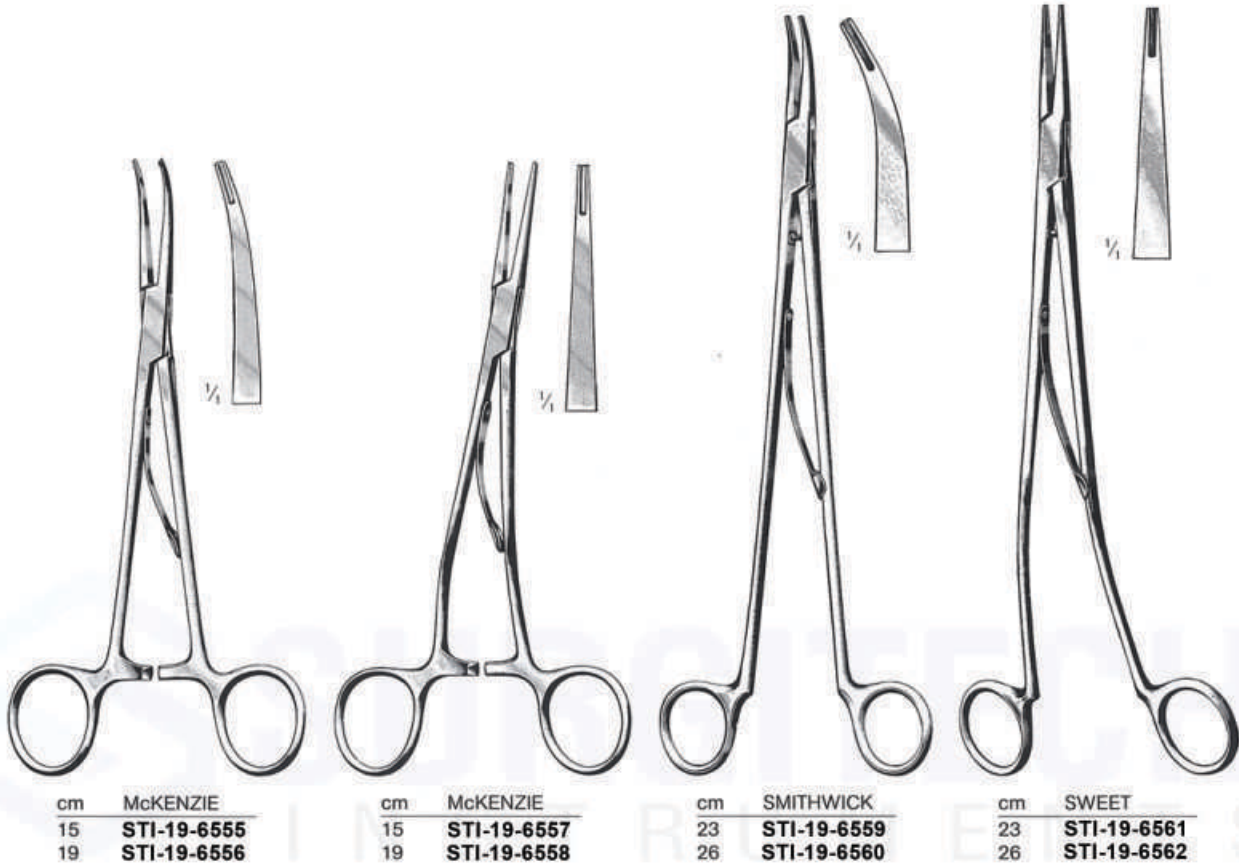

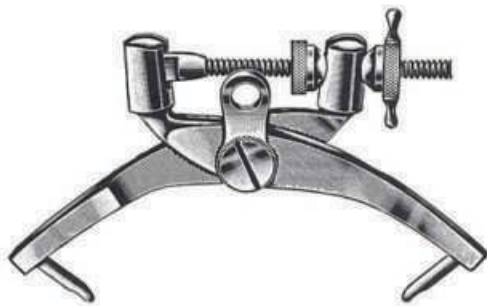

CRUTCHFIELD
STI-19-6566



CRUTCHFIELD
STI-19-6567



STI-19-6568
3,5 mm Ø



STI-19-6569
5 mm Ø

SURGITECH
INSTRUMENTS

Kopfhautklammer, -anlegezange
Scalp Hemostasis Clip, Applying Forceps
Pince hémostatique pour le cuir chevelu, pince à poser
Pinza hemostática para cuero cabelludo, pinza para poner
Pinza emostatica per il cuoio capelluto, pinza per applicare e togliere



RANEY
STI-19-6570



RANEY
STI-19-6571

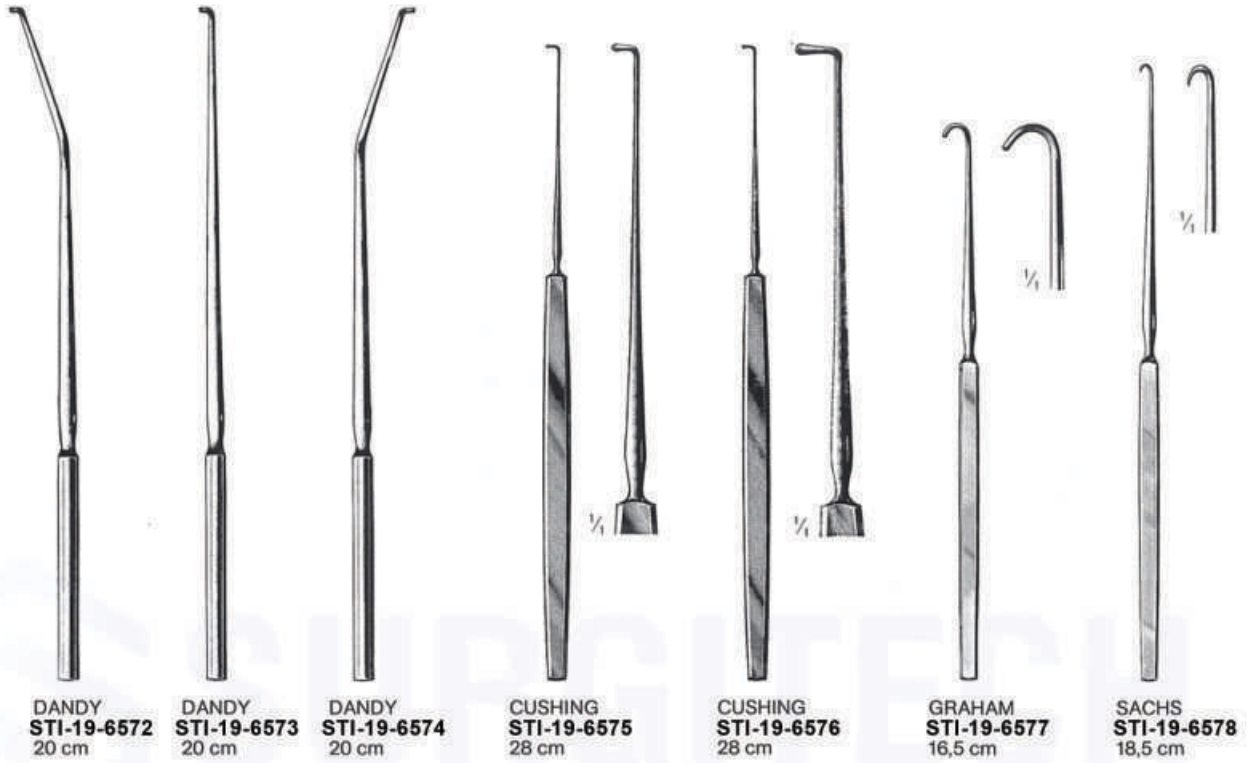



De MARTEL
STI-19-6585
33 cm

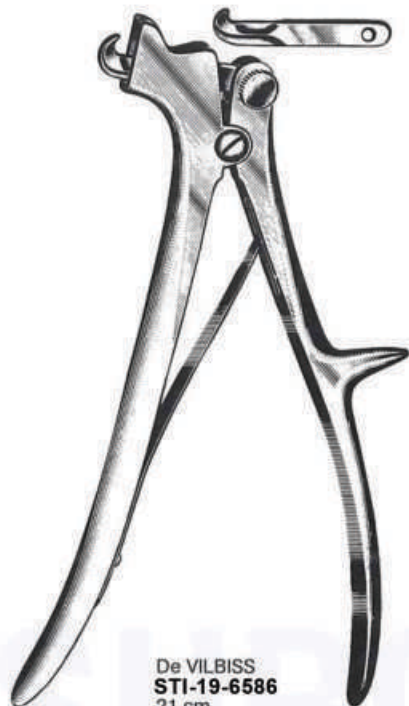

De VILBISS
STI-19-6586
21 cm

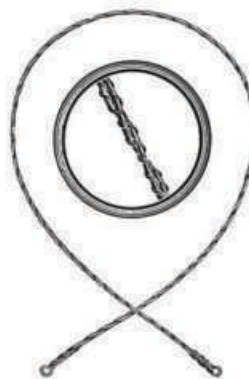

cm	OLIVECRONA
30	STI-19-6587
40	STI-19-6588
50	STI-19-6589
60	STI-19-6590
70	STI-19-6591



GIGLI
STI-19-6592
1 Paar
1 pair
1 paire
1 par
1 paio

Dura-Dissektoren · Dura Dissectors · Dissecteurs à duremère
Descoladores para la duramadre · Scollatori per la duramadre



TOENNIS
STI-19-6593
25 cm



SACHS
STI-19-6594



SACHS
STI-19-6595



MILLIGAN
STI-19-6596



STI-19-6597



DAVIS
STI-19-6598

Dura-Dissektoren, -Messer
Dura Dissectors, Knife
Dissecteurs, bistouri à duremère
Descoladores, bisturi para duramadre
Scollatori, bisturi per duramadre



PENFIELD
STI-19-6599
17,5 cm



PENFIELD
STI-19-6601
19,5 cm



PENFIELD
STI-19-6602
19,5 cm



PENFIELD
STI-19-6603
20,5 cm



PENFIELD
STI-19-6604
18,5 cm



HALLE
STI-19-6605

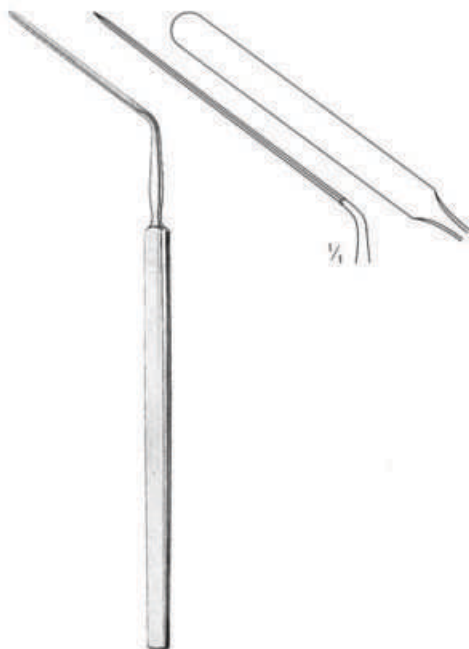

HORSLEY
STI-19-6606



ADSON
STI-19-6607



ADSON
STI-19-6608



ADSON
STI-19-6609

Hypophysenpinzetten · Hypophyseal Forceps · Pincés à hypophyse · Pinzas para hipófisis · Pinze per ipofisi



mm CUSHING
7/ 9 STI-19-6610
11/13 STI-19-6611
15/18 STI-19-6612
18/22 STI-19-6613
180 mm

mm OLIVECRONA
7/ 9 STI-19-6614
11/13 STI-19-6615
15/18 STI-19-6616
18/22 STI-19-6617
180 mm

mm HEIFETZ
8 STI-19-6618
11 STI-19-6619
14 STI-19-6620
17 STI-19-6621

ADSON
STI-19-6622
21 cm/4 mm

Charr. *
F.G. 30° 75°
6 STI-19-6623 STI-19-6631
7 STI-19-6624 STI-19-6632
8 STI-19-6625 STI-19-6633
9 STI-19-6626 STI-19-6634
10 STI-19-6627 STI-19-6635
11 STI-19-6628 STI-19-6636
12 STI-19-6629 STI-19-6637
15 STI-19-6630 STI-19-6638

FRAZIER
STI-19-6623-6638
19 cm

Wirbelkörperpreizer · Lamina Spreaders ·
Ecarteurs pour corps vertébraux ·
Separadores para cuerpos vertebrales ·
Divaricatori per corpi vertebrali



FRAZIER
STI-19-6639
12 cm/3 mm



CLOWARD
STI-19-6640

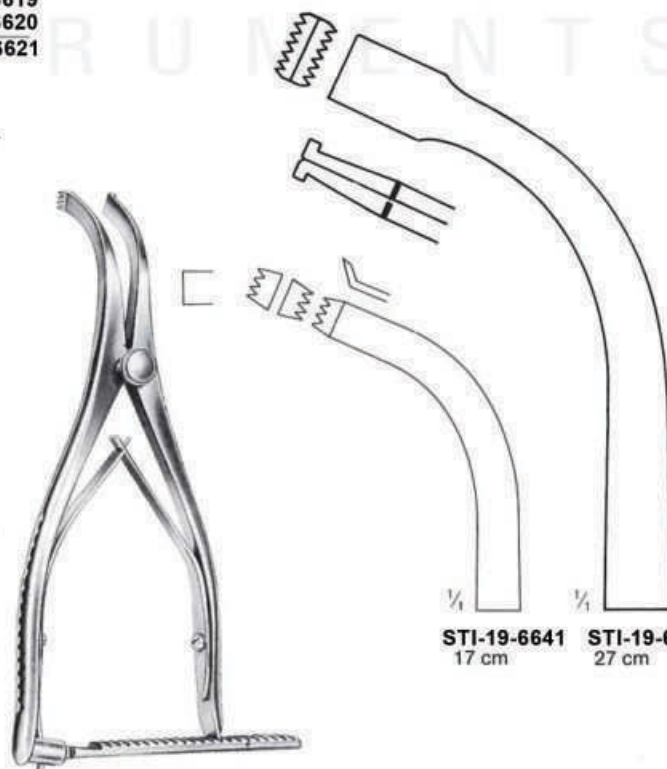

INGE
STI-19-6641-6642

STI-19-6641
17 cm

STI-19-6642
27 cm

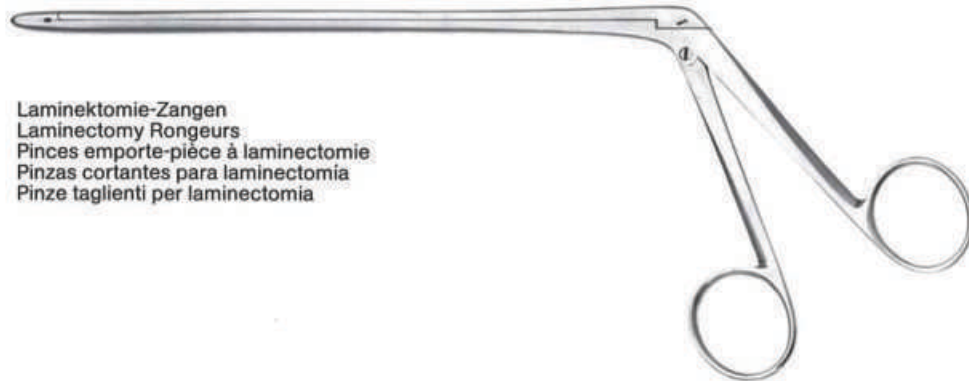

Laminektomie-Zangen
Laminectomy Rongeurs
Pincas emporte-pièce à laminectomie
Pinzas cortantes para laminectomia
Pinze taglianti per laminectomia

CUSHING
2 mm

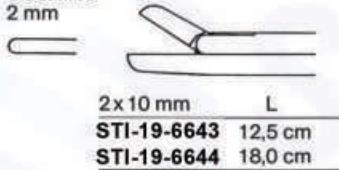

LOVE-GRUENWALD
3 mm

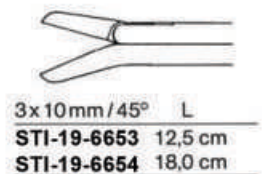
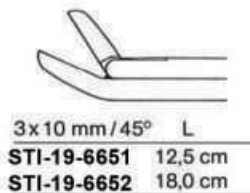
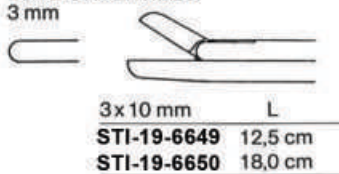

SPURLING
4 mm

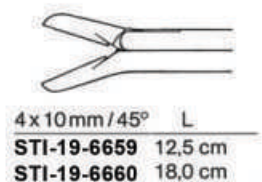
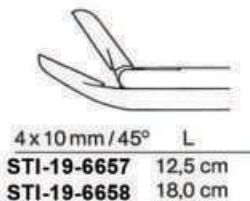

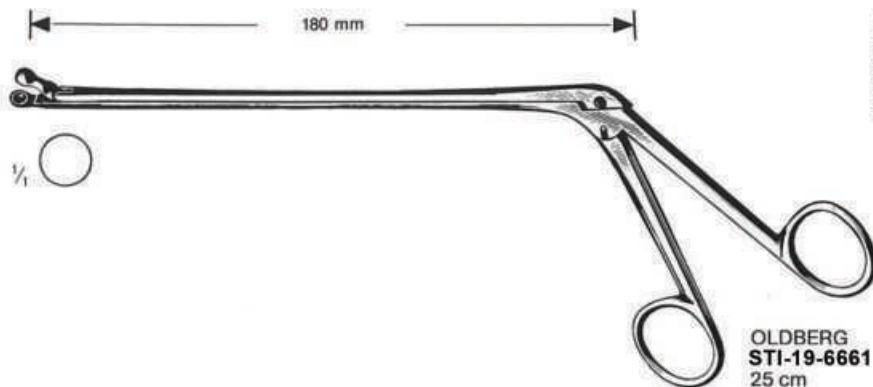

Laminektomie-Zangen
Laminectomy Rongeurs
Pincas emporte-pièce à laminectomie
Pinzas cortantes para laminectomia
Pinze taglienti per laminectomia

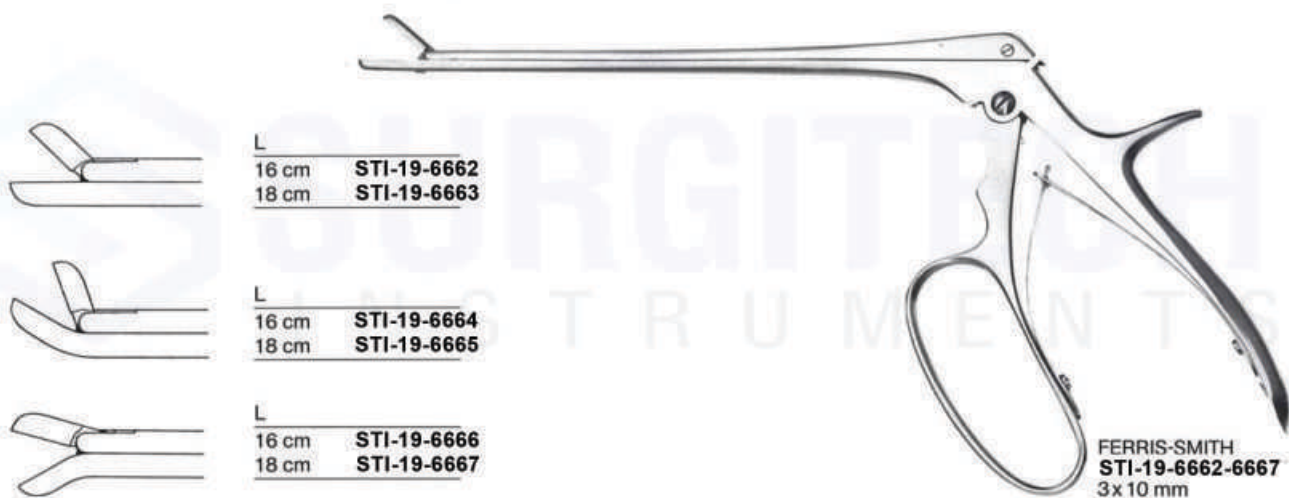

Bandscheiben-Stanzen
Intervertebral Disc Rongeurs
Pincas emporte-pièce pour lames intervertébrales
Pinzas sacabocado para discos intervertebrales
Pinze taglienti per dischi intervertebrali



FERRIS-SMITH-KERRISON
STI-19-6669-6681
18 cm



STI-19-6669
1 mm



STI-19-6670
1 mm

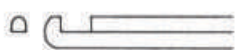

STI-19-6671
2 mm

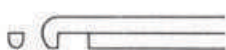

STI-19-6672
2 mm

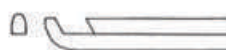

STI-19-6673
2 mm

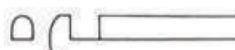

STI-19-6674
3 mm

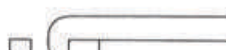

STI-19-6675
3 mm



STI-19-6676
3 mm



STI-19-6677
4 mm



STI-19-6678
4 mm



STI-19-6679
5 mm



STI-19-6680
5 mm



STI-19-6681
5 mm

Bandscheiben-Stanzen
Intervertebral Disc Rongeurs
Pincas emporte-pièce pour lames intervertébrales
Pinzas sacabocado para discos intervertebrales
Pinze taglianti per dischi intervertebrali



COLCLOUGH
STI-19-6682-6693

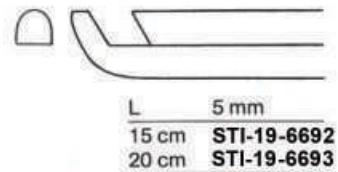
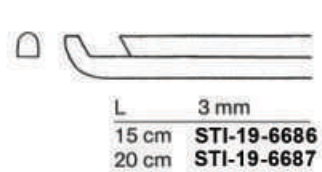
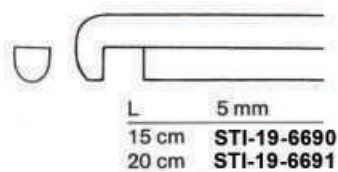
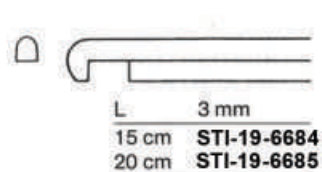
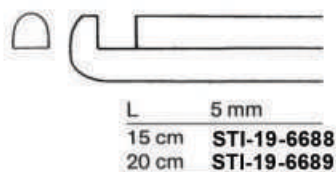
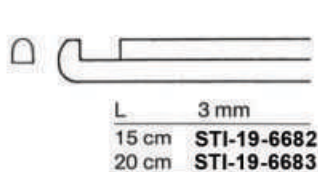

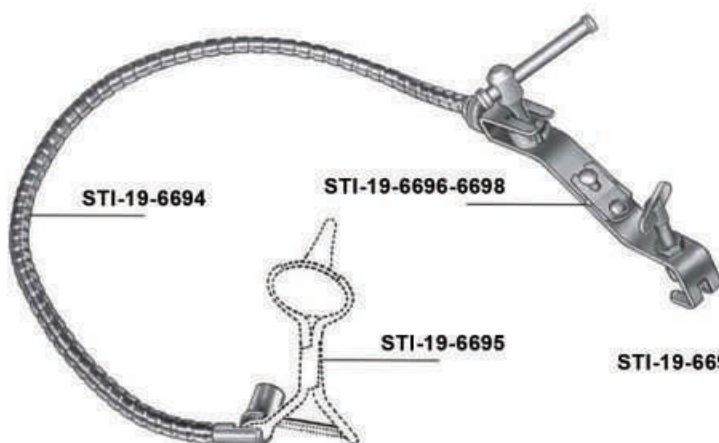

STI-19-6694 Spannarm allein
 Flexible arm only
 Bras flexible seul
 Brazo flexible suelto
 Braccio flessibile solo

STI-19-6695 Ohrtrichterhalter allein
 Ear specula holder only
 Support pour spéculum auriculaire
 Soporte para espéculo de oídos
 Sostegno per specolo auricolare

STI-19-6696 Fixiervorrichtungen für Schädel oder Starrarm
STI-19-6697 Fixation bases for skull or rigid holding arm
STI-19-6698 Bases pour fixation au crâne ou au bras rigide
 Fijadores para fijación al cráneo o al brazo rígido
 Fissatori per fissaggio al cranio o al braccio rigido



STI-19-6699

STI-19-6699 Fixiervorrichtung am Schädel für 1 Arm
 Fixation base for 1 arm at skull
 Base de fixation pour 1 bras au crâne
 Fijador para 1 brazo al cráneo
 Fissatore per 1 braccio al cranio



STI-19-6701

STI-19-6701 Fixiervorrichtung am Schädel für 2 Arme
 Fixation base for 2 arms at skull
 Base de fixation pour 2 bras au crâne
 Fijador para 2 brazos al cráneo
 Fissatore per 2 bracci al cranio



STI-19-6702

STI-19-6702 Fixiervorrichtung am Starrarm für 1 Arm
 Fixation base for 1 arm at rigid arm
 Base de fixation pour 1 bras au bras rigide
 Fijador para 1 brazo al brazo rígido
 Fissatore per 1 braccio al braccio rigido



STI-19-6706

Hirnspatelhalter, selbsthaltend, flexibel,
für flache Spatel,
mit 1 Spannarm, komplett, bestehend aus:
STI-19-6703,STI-19-6704,STI-19-6705

Brain retractor, self retaining, flexible,
for flat spatula,
with 1 flexible arm, complete, consisting of:
STI-19-6703,STI-19-6704,STI-19-6705

Ecarteur autostatique, flexible,
pour des spatules plates,
avec un bras flexible, complet, composé de:
STI-19-6703,STI-19-6704,STI-19-6705

Separador autorretentivo, flexible,
para espátulas llanas,
con 1 brazo flexible, completo, compuesto de:
STI-19-6703,STI-19-6704,STI-19-6705

Divaricatore autostatico, flessibile,
per spatole piatte,
con 1 braccio flessibile, completo, composto da:
STI-19-6703,STI-19-6704,STI-19-6705



STI-19-6707 Halter für flache Hirnspatel
Holder for flat brain spatula
Support pour des spatules plates
Soporte para espátulas llanas
Sostegno per spatole piatte

STI-19-6708 Halter für Hirnspatel mit rundem Schaft
Holder for brain spatula with round stem
Support pour des spatules a tige ronde
Soporte para espátulas con vástago redondo
Sostegno per spatole con asta rotonda

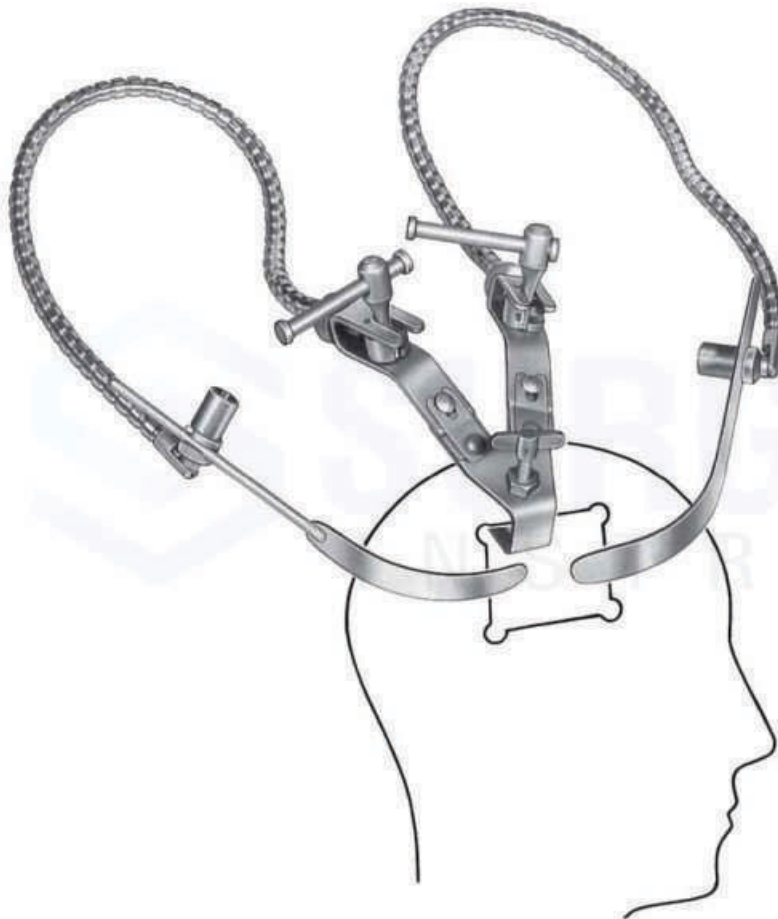

STI-19-6712

Hirnspatelhalter, selbsthaltend, flexibel,
für flache Spatel,
mit 2 Spannarmen, komplett, bestehend aus:
2 x STI-19-6709, STI-19-6710, STI-19-6711

Brain retractor, self retaining, flexible,
for flat spatula,
with 2 flexible arms, complete, consisting of:
2 x STI-19-6709, STI-19-6710, STI-19-6711

Ecarteur autostatique, flexible,
pour des spatules plates,
avec 2 bras flexibles, complet, composé de:
2 x STI-19-6709, STI-19-6710, STI-19-6711

Separador autorretentivo, flexible,
para espátulas llanas,
con 2 brazos flexibles, completo, compuesto de:
2 x STI-19-6709, STI-19-6710, STI-19-6711

Divaricatore autostatico, flessibile,
per spatole piatte,
con 2 bracci flessibili, completo, composto da:
2 x STI-19-6709, STI-19-6710, STI-19-6711

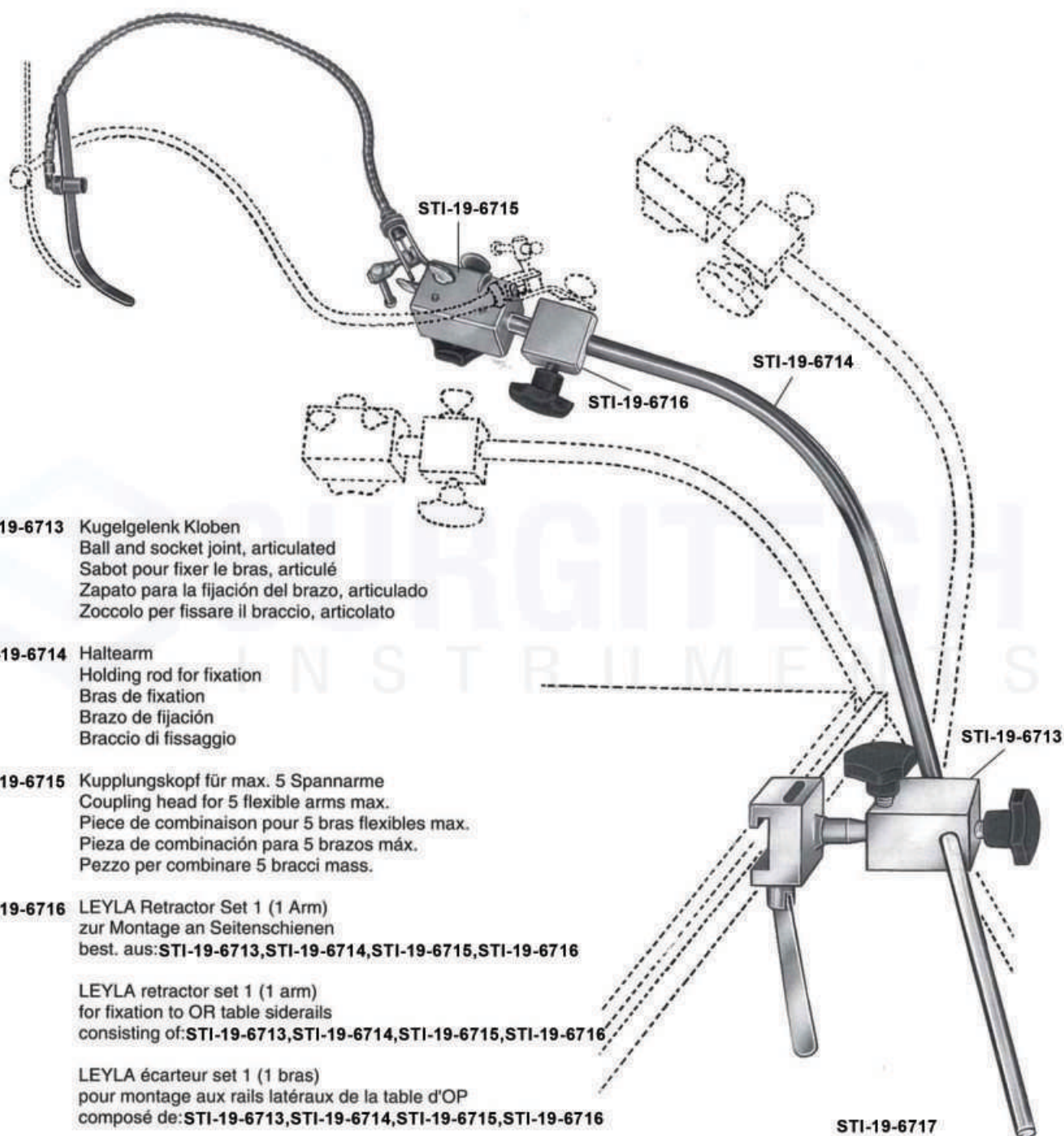

STI-19-6713 Kugelgelenk Kloben
 Ball and socket joint, articulated
 Sabot pour fixer le bras, articulé
 Zapato para la fijación del brazo, articulado
 Zoccolo per fissare il braccio, articolato

STI-19-6714 Haltearm
 Holding rod for fixation
 Bras de fixation
 Brazo de fijación
 Braccio di fissaggio

STI-19-6715 Kupplungskopf für max. 5 Spannarme
 Coupling head for 5 flexible arms max.
 Piece de combinaison pour 5 bras flexibles max.
 Pieza de combinación para 5 brazos máx.
 Pezzo per combinare 5 bracci mass.

STI-19-6716 LEYLA Retractor Set 1 (1 Arm)
 zur Montage an Seitenschienen
 best. aus: **STI-19-6713, STI-19-6714, STI-19-6715, STI-19-6716**

LEYLA retractor set 1 (1 arm)
 for fixation to OR table siderails
 consisting of: **STI-19-6713, STI-19-6714, STI-19-6715, STI-19-6716**

LEYLA écarteur set 1 (1 bras)
 pour montage aux rails latéraux de la table d'OP
 composé de: **STI-19-6713, STI-19-6714, STI-19-6715, STI-19-6716**

LEYLA separador set 1 (1 brazo)
 para montar al carril lateral de la mesa operatoria
 compuesto de: **STI-19-6713, STI-19-6714, STI-19-6715, STI-19-6716**

LEYLA divaricatore set 1 (1 braccio)
 per montaggio al tavolo di operazione
 composto da: **STI-19-6713, STI-19-6714, STI-19-6715, STI-19-6716**

- STI-19-6718** Kugelgelenk Kloben
Ball and socket joint, articulated
Sabot pour fixer le bras, articulé
Zapato para la fijación del brazo, articulado
Zoccolo per fissare il braccio, articolato
- STI-19-6719** Haltearm
Holding rod for fixation
Bras de fixation
Brazo de fijación
Braccio di fissaggio
- STI-19-6720** Kupplungskopf für max. 5 Spannarme
Coupling head for 5 flexible arms max.
Pièce de combinaison pour 5 bras flexibles max.
Pieza de combinación para 5 brazos máx.
Pezzo per combinare 5 bracci mass.
- STI-19-6721** Kupplungskopf drehbar
Coupling head rotatable
Pièce de combinaison rotative
Pieza de combinación giratoria
Pezzo per combinare girevole
- STI-19-6722** LEYLA Retractor Set 2 (2 Arme) zur Montage an Seitenschiene
best. aus: **STI-19-6718,STI-19-6719,STI-19-6720,STI-19-6721**
- LEYLA retractor set 2 (2 arms) for fixation to OR table siderails
consisting of: **STI-19-6718,STI-19-6719,STI-19-6720,STI-19-6721**
- LEYLA écarteur set 2 (2 bras) pour montage aux rails latéraux
de la table d'OP
composé de: **STI-19-6718,STI-19-6719,STI-19-6720,STI-19-6721**
- LEYLA separador set 2 (2 brazos) para montar al carril lateral de la
mesa operatoria
compuesto de: **STI-19-6718,STI-19-6719,STI-19-6720,STI-19-6721**
- LEYLA divaricatore set 2 (2 bracci) per montaggio
al tavolo di operazione
composto da: **STI-19-6718,STI-19-6719,STI-19-6720,STI-19-6721**





Otology

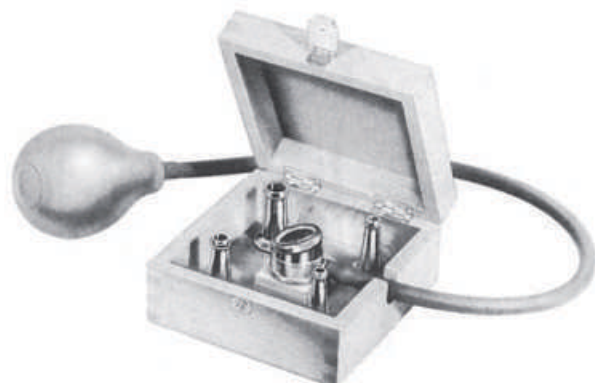
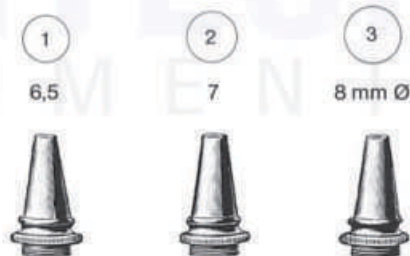
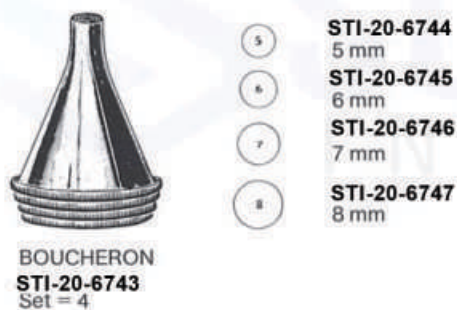



STI-20-6750 C 128 **STI-20-6751** C¹ 256 **STI-20-6752** C² 512 **STI-20-6753** C³ 1024 **STI-20-6754** C⁴ 2048

DIMEDA Alu



DIMEDA Alu
STI-20-6755
compl.

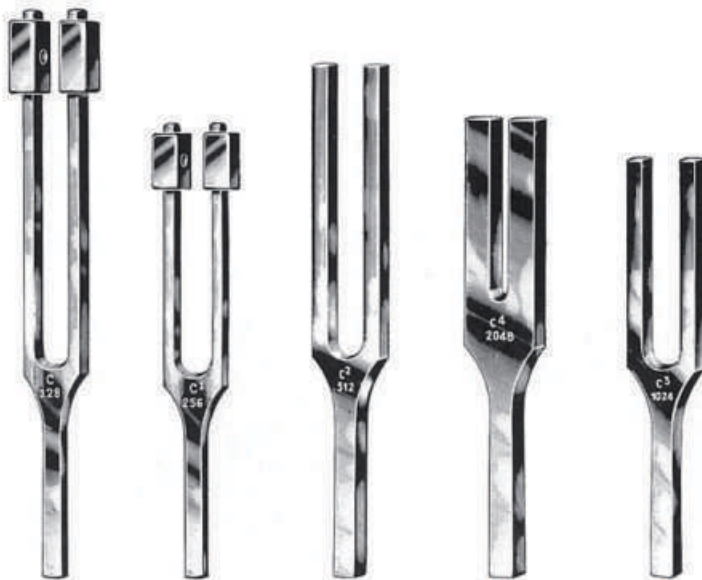

STI-20-6756 C 128 **STI-20-6757** C¹ 256 **STI-20-6758** C² 512 **STI-20-6759** C³ 1024 **STI-20-6760** C⁴ 2048

HARTMANN



HARTMANN
STI-20-6761
compl.



LUCAE
STI-20-6762
C 128



STI-20-6763
neurolog.



RYDEL-SEIFFER
STI-20-6764
C 64/c 128

Lärmapparat
Noise Apparatus
Assourdisseur
Ensordeceur
Assordatore



BARANY
STI-20-6765

Pulverbläser
Powder Blowers
Lance-Poudre
Lanzapolvero
Insuffiatori per polvere

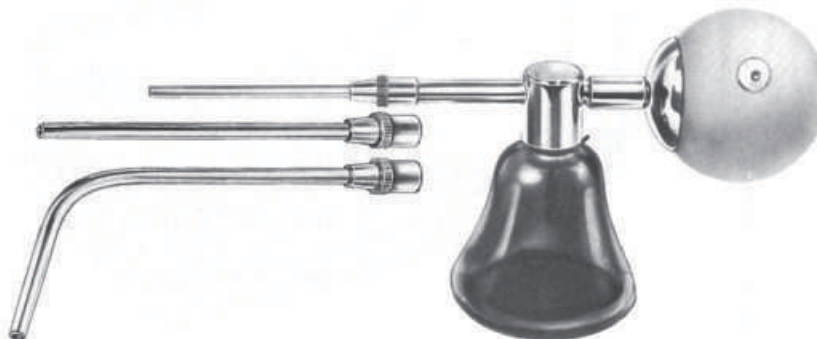

KABIERSKE
STI-20-6766
30 cc

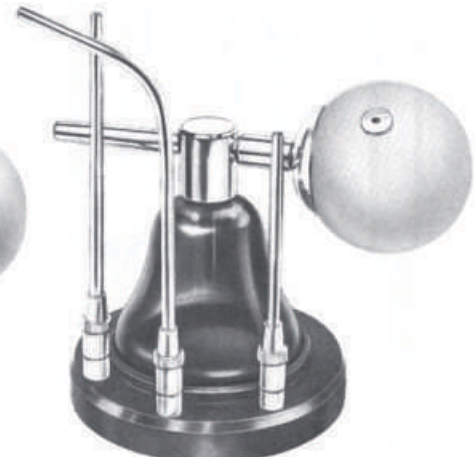

KABIERSKE
STI-20-6767
30 cc



POLITZER
STI-20-6768



STI-20-6769



STI-20-6770
4 mm Ø



STI-20-6771
15 mm Ø



STI-20-6772
17 mm Ø



STI-20-6773
22 mm Ø

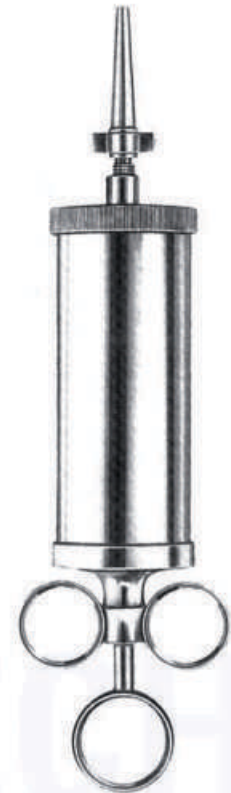

ml	REINER
50	STI-20-6774
75	STI-20-6775
100	STI-20-6776
150	STI-20-6777

Küretten · Curettes ·
Curettes · Curetas ·
Curette



BUCK



stumpf · blunt
mousses
romas
smusse



Fig. 00

0

1

2

3

4

5

STI-20-6778

STI-20-6779

STI-20-6780

STI-20-6781

STI-20-6782

STI-20-6783

STI-20-6784

scharf · sharp
tranchantes
cortantes
taglienti



STI-20-6785

STI-20-6786

STI-20-6787

STI-20-6788

STI-20-6789

STI-20-6790

STI-20-6791

stumpf · blunt
mousses
romas
smusse



STI-20-6792

STI-20-6793

STI-20-6794

STI-20-6795

STI-20-6796

STI-20-6797

STI-20-6798

scharf · sharp
tranchantes
cortantes
taglienti



STI-20-6799

STI-20-6801

STI-20-6802

STI-20-6803

STI-20-6804

STI-20-6805

STI-20-6806

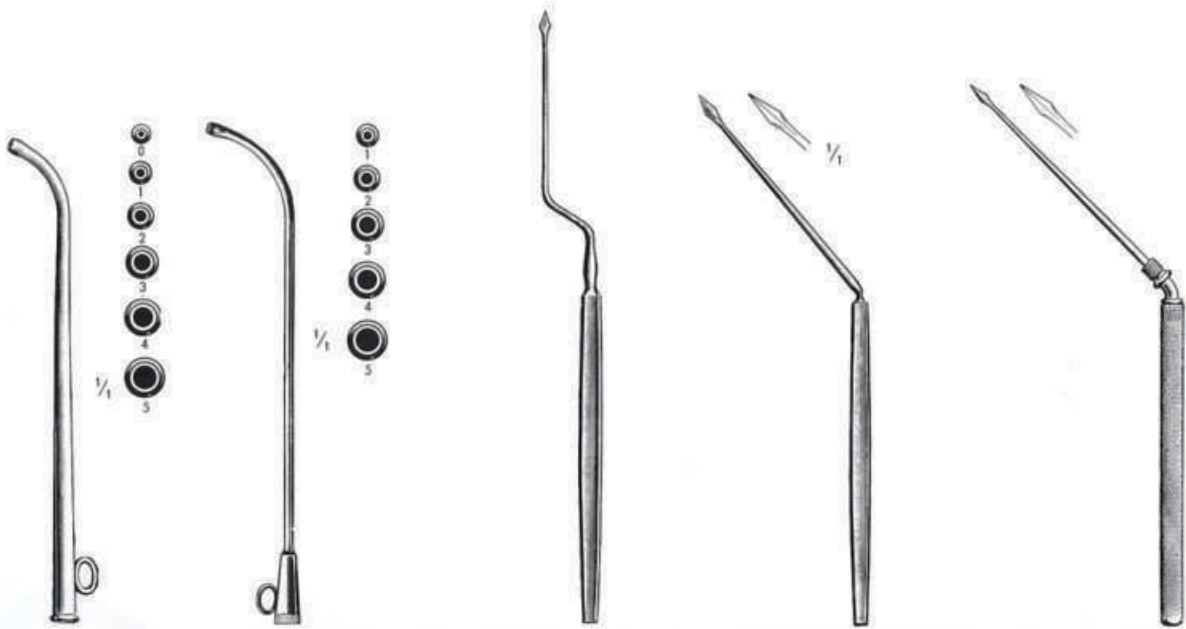

Fig.	HARTMANN	ITARD
0	STI-20-6807	
1	STI-20-6808	STI-20-6813
2	STI-20-6809	STI-20-6814
3	STI-20-6810	STI-20-6815
4	STI-20-6811	STI-20-6816
5	STI-20-6812	STI-20-6817

POLITZER
STI-20-6818
 18 cm

POLITZER
STI-20-6819
 16,5 cm

POLITZER
STI-20-6820



POLITZER
STI-20-6821
 15 cm

SEXTON
STI-20-6822
 18 cm

SEXTON
STI-20-6823
 17 cm

SEXTON
STI-20-6824
 17 cm

GROSS
STI-20-6825
 12 cm

GROSS
STI-20-6826
 12 cm

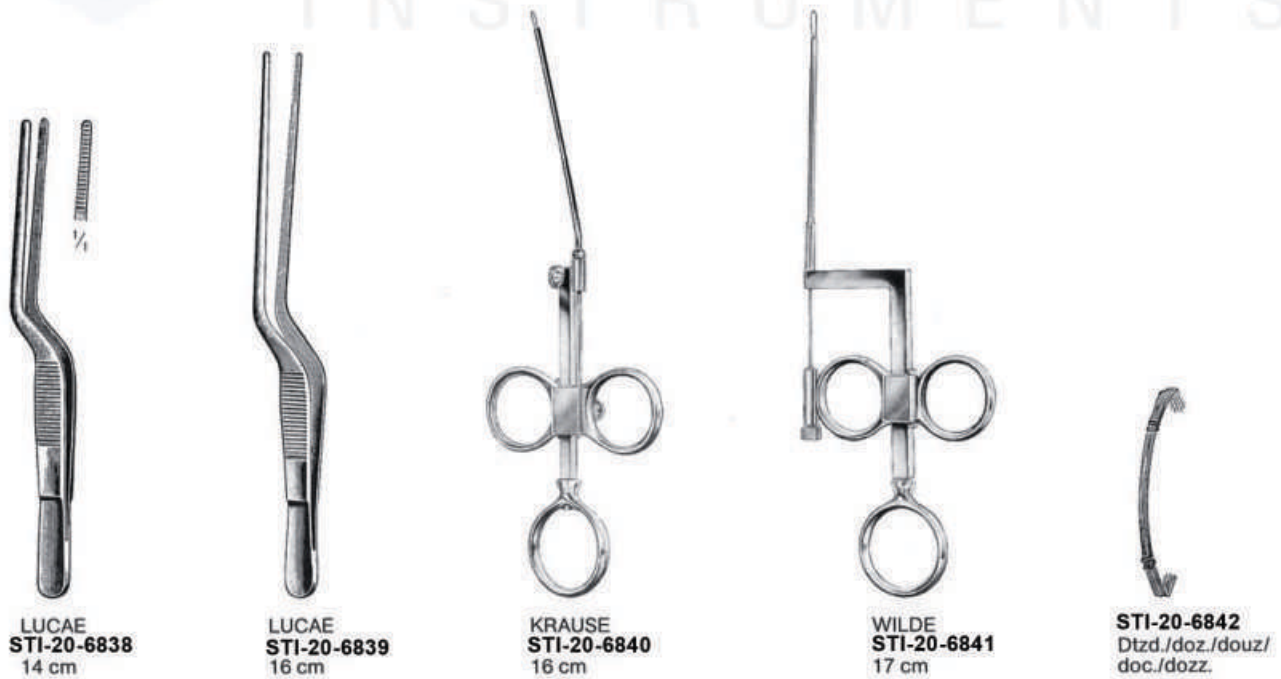
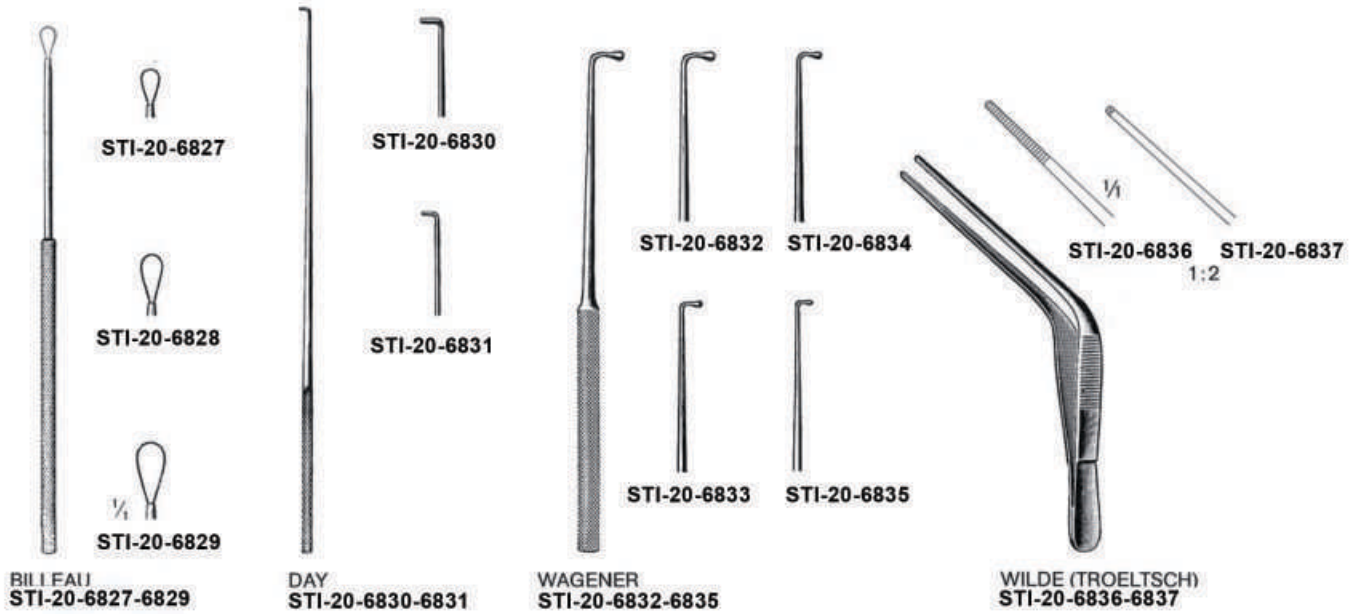



QUIRE
STI-20-6847
 10 cm

Fremdkörperhebel
 Foreign Body Levers
 Leviers pour corps étrangers
 Elevadores para cuerpos extranjeros
 Leve per corpi estranei



BUCK
STI-20-6848
 11 cm



STI-20-6849-6863



HARTMANN-WULLSTEIN
STI-20-6849
 8,5 cm



HARTMANN-WULLSTEIN
STI-20-6850
 8,5 cm



cm	HARTMANN
8,5	STI-20-6851
14,0	STI-20-6852
16,0	STI-20-6853



cm	HARTMANN
8,5	STI-20-6854
14,0	STI-20-6855



HARTMANN
STI-20-6856
 8,5 cm



Ø mm	HARTMANN
2,0	STI-20-6857
2,5	STI-20-6858
3,0	STI-20-6859

8,5 cm

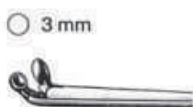

HARTMANN
STI-20-6860
 8,5 cm



STRUEMPEL
STI-20-6861
 8,5 cm



HARTMANN
STI-20-6862
 8,5 cm



HARTMANN-HOFFMANN
STI-20-6863
 8,5 cm

Mikro-Ohrscherchen
 Micro Ear Scissors
 Ciseaux auriculaires micro
 Tijeras auriculares micro
 Forbici auricolari micro



STI-20-6864-6871

gerade
 straight
 droite
 recta
 retta



BELLUCCI
STI-20-6864
 micro mini
 4 mm

links
 left
 gauche
 izquierda
 sinistra



BELLUCCI
STI-20-6867
 micro standard
 5,5 mm

gerade
 straight
 droite
 recta
 retta



SHEA
STI-20-6869
 7,0 mm

gerade
 straight
 droite
 recta
 retta



BELLUCCI
STI-20-6865
 micro standard
 5,5 mm

rechts
 right
 droite
 derecha
 retta



BELLUCCI
STI-20-6868
 micro standard
 5,5 mm

links
 left
 gauche
 izquierda
 sinistra



SHEA
STI-20-6870
 7,0 mm

aufgebogen
 bent upwards
 courbée vers le haut
 curva por arriba
 curva in alto



BELLUCCI
STI-20-6866
 micro standard
 5,5 mm

rechts
 right
 droite
 derecha
 retta



SHEA
STI-20-6871
 7,0 mm

gerieft, gerade
 serrated, straight
 striée, droite
 estriada, recta
 con scanalatura, retta



STI-20-6872
 4 mm

gerieft, gerade
 serrated, straight
 striée, droite
 estriada, recta
 con scanalatura, retta



STI-20-6873
 7 mm

glatt, gerade
 smooth, straight
 lisse, droite
 lisa, recta
 liscia, retta



STI-20-6874
 4 mm

Mikro-Ohrzängchen
 Micro Ear Forceps
 Pinces auriculaires micro
 Pinzas auriculares micro
 Pinze auricolari micro



STI-20-6872-6879

links, gerieft
 left, serrated
 gauche, striée
 izquierda, estriada
 sinistra, con scanalatura



STI-20-6875
 6 mm

rechts, gerieft
 right, serrated
 droite, striée
 derecha, estriada
 retta, con scanalatura



STI-20-6876
 6 mm

aufgebogen, gerieft
 bent upwards, serrated
 courbée vers le haut, striée
 curva por arriba, estriada
 curva in alto, con scanalatura



STI-20-6877
 4 mm

abwärts gebogen, gerieft
 downwards, serrated
 courbée en bas, striée
 curva hacia abajo, estriada
 curva in basso, con scanalatura



STI-20-6878
 4 mm

gerieft, gerade
 serrated, straight
 striée, droite
 estriada, recta
 con scanalatura, retta



STI-20-6879
 3,5 mm

rechts
 right
 droite
 derecha
 retta



STI-20-6880
 4,5 mm

links
 left
 gauche
 izquierda
 sinistra



STI-20-6881
 4,5 mm

gerade
 straight
 droite
 recta
 retta



STI-20-6882
 4,5 mm



STI-20-6883
 5,0 mm



STI-20-6884
 5,0 mm

abgebogen
 bent downwards
 courbée vers le bas
 curva por abajo
 curva in basso



GREVEN
STI-20-6885
 5,0 mm



STI-20-6880-6886

abgebogen
 bent downwards
 courbée vers le bas
 curva por abajo
 curva in basso



McGEE
STI-20-6886
 0,8x4,0 mm



DIETER
STI-20-6887-6890

Hammerkopf-Zwickzängchen
 Malleus Nippers
 Pincas pour la tête du marteau
 Pinzas para la cabeza del martillo
 Pinze per la testa del martello

micro



STI-20-6887

aufwärts
 upward
 en haut
 arriba
 in alto

mini

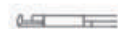

STI-20-6889



STI-20-6888

abwärts
 downward
 en bas
 abajo
 in basso



STI-20-6890

Modelle mit Ringgriff
Ring Handle Patterns
Modèles manches à anneaux
Modelos mangos con anillos
Modelli manici con anelli

Modelle mit Bleistiftgriff
Pencil Handle Patterns
Modèles manches crayon
Modelos mango en forma de lapiz
Modelli manico forma matita

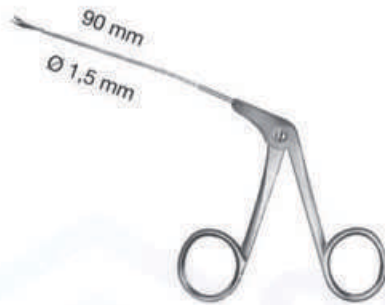

WULLSTEIN
STI-20-6891-6896
micro
RG

STI-20-6891



STI-20-6904

STI-20-6892



STI-20-6905

STI-20-6893



STI-20-6906

STI-20-6894



STI-20-6907

STI-20-6895



STI-20-6908.

STI-20-6896



STI-20-6909



STI-20-6910

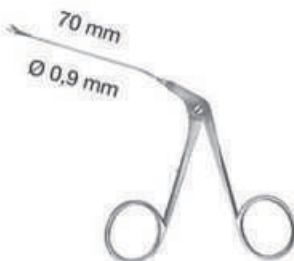

WULLSTEIN
STI-20-6897-6903
micro-mini
RG

STI-20-6897



STI-20-6911

STI-20-6898



STI-20-6912

STI-20-6899



STI-20-6913

STI-20-6901



STI-20-6914

STI-20-6902



STI-20-6915

STI-20-6903



STI-20-6916



STI-20-6904-6910
micro
BG

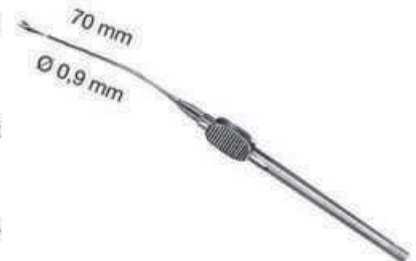

STI-20-6911-6916
micro-mini
BG



Modelle mit Ringgriff
 Ring handle Patterns
 Modèles manches à anneaux
 Modelos mangos con anillos
 Modelli manici con anelli

STI-20-6891-6946
 micro
 RG

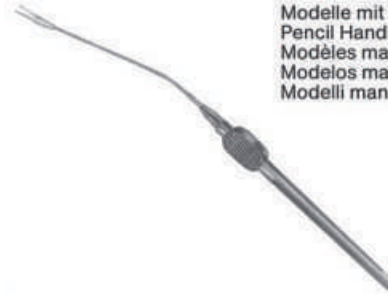

Modelle mit Bleistiftgriff
 Pencil Handle Patterns
 Modèles manches crayon
 Modelos mango en forma de lapiz
 Modelli manico forma matita

STI-20-6847-6975
 micro
 BG

- | | | |
|--------------------|--|--------------------|
| STI-20-6917 | | STI-20-6947 |
| STI-20-6918 | | STI-20-6948 |
| STI-20-6919 | | STI-20-6949 |
| STI-20-6920 | | STI-20-6950 |
| STI-20-6921 | | STI-20-6951 |
| STI-20-6922 | | STI-20-6952 |
| STI-20-6923 | | STI-20-6953 |
| STI-20-6924 | | STI-20-6954 |
| STI-20-6925 | | STI-20-6955 |
| STI-20-6926 | | |

- | Ø 1 mm | Ø 1,5 mm | Ø 2 mm | Ø 2,5 mm | | Ø 1 mm | Ø 1,5 mm | Ø 2 mm | Ø 2,5 mm |
|--------------------|--------------------|--------------------|--------------------|--|--------------------|--------------------|--------------------|--------------------|
| STI-20-6927 | STI-20-6928 | STI-20-6929 | STI-20-6930 | | STI-20-6956 | STI-20-6957 | STI-20-6958 | STI-20-6959 |
| STI-20-6931 | STI-20-6932 | STI-20-6933 | STI-20-6934 | | STI-20-6960 | STI-20-6961 | STI-20-6962 | STI-20-6963 |
| STI-20-6935 | STI-20-6936 | STI-20-6937 | STI-20-6938 | | STI-20-6964 | STI-20-6965 | STI-20-6966 | STI-20-6967 |
| STI-20-6939 | STI-20-6940 | STI-20-6941 | STI-20-6942 | | STI-20-6968 | STI-20-6969 | STI-20-6970 | STI-20-6971 |
| STI-20-6943 | | STI-20-6972 | | | | | | |
| STI-20-6944 | | STI-20-6973 | | | | | | |
| STI-20-6945 | | STI-20-6974 | | | | | | |
| STI-20-6946 | | STI-20-6975 | | | | | | |

Modelle mit Ringgriff
 Ring Handle Patterns
 Modèles manches à anneaux
 Modelos mangos con anillos
 Modelli manici con anelli



STI-20-6976-6993
 micro-mini
 RG

Modelle mit Bleistiftgriff
 Pencil Handle Patterns
 Modèles manches crayon
 Modelos mango en forma de lapiz
 Modelli manico forma matita



STI-20-6994-7010
 micro-mini
 BG

STI-20-6976		STI-20-6994
STI-20-6977		STI-20-6995
STI-20-6978		STI-20-6996
STI-20-6979		STI-20-6997
STI-20-6980		STI-20-6998
STI-20-6981		
STI-20-6982		STI-20-6999
STI-20-6983		STI-20-7001
STI-20-6984		STI-20-7002
STI-20-6985		
STI-20-6986		STI-20-7003
STI-20-6987		STI-20-7004
STI-20-6988		STI-20-7005
STI-20-6989		STI-20-7006
STI-20-6990		STI-20-7007
STI-20-6991		STI-20-7008
STI-20-6992		STI-20-7009
STI-20-6993		STI-20-7010



SCHUKNECHT
STI-20-7011



SCHUKNECHT
STI-20-7012



SCHUKNECHT
STI-20-7013
 15,5 cm



WULLSTEIN
STI-20-7014
 15,5 cm



TABB
STI-20-7015
 15,5 cm



PLESTER
STI-20-7016
 15,5 cm/3,5 mm Ø



ROSEN
STI-20-7017-7023

STI-20-7017 1,0 mm **STI-20-7018** 1,4 mm **STI-20-7019** 1,6 mm **STI-20-7020** 2,0 mm

STI-20-7021 2,6 mm **STI-20-7022** 2,8 mm **STI-20-7023** 3,0 mm



STI-20-7024-7046

BARBARA **BARBARA** **BARBARA** **ROSEN**
STI-20-7024 **STI-20-7025** **STI-20-7026** **STI-20-7027**

mm	25° BARBARA	45° BARBARA	90° BARBARA	BARBARA
0,3	STI-20-7028	STI-20-7031	STI-20-7038	STI-20-7045 0,5 mm
0,6	STI-20-7029	STI-20-7032	STI-20-7039	STI-20-7046 1,0 mm
1,0	STI-20-7030	STI-20-7033	STI-20-7040	
1,2		STI-20-7034	STI-20-7041	
1,5		STI-20-7035	STI-20-7042	
2,0		STI-20-7036	STI-20-7043	
2,5		STI-20-7037	STI-20-7044	



mm	90°	90°	mm	McGEE	McGEE	BARBARA
0,3	STI-20-7047	STI-20-7050	0,5	STI-20-7053	STI-20-7055	STI-20-7057
0,6	STI-20-7048	STI-20-7051	1,0	STI-20-7054	STI-20-7056	15,5 cm
1,0	STI-20-7049	STI-20-7052				



STI-20-7071 STI-20-7072

STI-20-7073 STI-20-7074

FISCH
STI-20-7071-7074

mm	25°	25°	45°	45°
0,3	STI-20-7059	STI-20-7062	STI-20-7065	STI-20-7068
0,6	STI-20-7060	STI-20-7063	STI-20-7066	STI-20-7069
1,0	STI-20-7061	STI-20-7064	STI-20-7067	STI-20-7070

ROSEN
STI-20-7058
15,5 cm



STI-20-7075
2 mm

STI-20-7076
2 mm

STI-20-7077
3 mm

LEMPERT
STI-20-7075-7077



mm			
1,0/1,2	STI-20-7078		
1,5/1,8	STI-20-7079		

mm			
1,0/1,2	STI-20-7080		
1,5/1,8	STI-20-7081		

HOUSE
STI-20-7078-7081



3,5 mm
STI-20-7082

4 mm

STI-20-7083

4,5 mm

STI-20-7084

5 mm

STI-20-7085

HOUSE
STI-20-7082-7085



LEMPERT
STI-20-7086
20,5 cm



mm PASSOW
2x2 STI-20-7087
3x3 STI-20-7088



MUCK
STI-20-7089
13 cm



Rhinology

Nasenspekula
 Nasal Specula
 Spéculums nasaux
 Espéculos nasales
 Specoli nasali

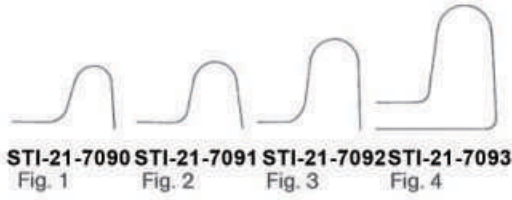

STI-21-7090 STI-21-7091 STI-21-7092 STI-21-7093
 Fig. 1 Fig. 2 Fig. 3 Fig. 4

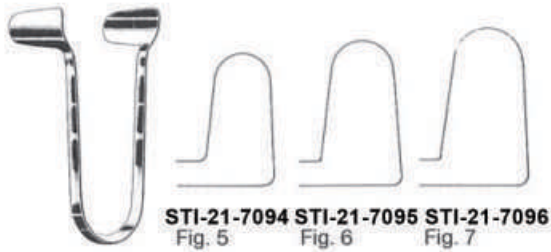

STI-21-7094 STI-21-7095 STI-21-7096
 Fig. 5 Fig. 6 Fig. 7

THUDICHUM
STI-21-7090-7096



STI-21-7097
 Fig. 1



STI-21-7098
 Fig. 2



STI-21-7099
 Fig. 3



VOLTOLINI
STI-21-7097-7099



STI-21-7101
 Fig. 1

STI-21-7102
 Fig. 2

STI-21-7103
 Fig. 3

HARTMANN-HALLE
STI-21-7101-7103
 15 cm



Mod. Wien · Vienna ·
 Vienne · Viena

Baby · Bébé **STI-21-7104**
 Kind · child · enf. · niño · bamb. **STI-21-7105**
 Erw. · Adult. **STI-21-7106**



Mod. Wien · Vienna
 Vienne · Viena
STI-21-7107
 leichtes Modell
 lightweight
 mod. léger
 mod. ligero
 mod. leggero



TIECK-HALLE
STI-21-7108
13,5 cm



KILLIAN
STI-21-7109-7112
13 cm



STI-21-7109
35 mm

STI-21-7110
50 mm

STI-21-7111
75 mm

STI-21-7112
90 mm



COTTLE
STI-21-7113-7116
14 cm



COTTLE
STI-21-7117-7120
schwarz · black · noirs
negros · neri
14 cm



STI-21-7113
STI-21-7117

STI-21-7114
STI-21-7118

STI-21-7115
STI-21-7119

STI-21-7116
STI-21-7120



YANKAUER
STI-21-7121
 19 cm



MICHEL
STI-21-7122-7125
 25 cm



STI-21-7122
 12 mm



STI-21-7123
 14 mm



STI-21-7124
 16 mm



STI-21-7125
 18 mm



TROELTSCH
STI-21-7126
 15 cm

TROELTSCH
STI-21-7127
 18 cm



JANSEN
STI-21-7128
 20 cm

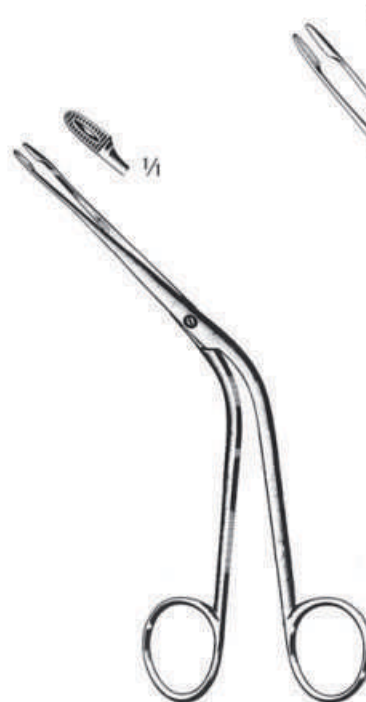

HARTMANN
STI-21-7129
 16 cm



HARTMANN
STI-21-7130
 20 cm



LUBET-BARBON
STI-21-7131
20 cm

LITTAUER
STI-21-7132
18 cm

HEYMANN-KNIGHT
STI-21-7133
18 cm

NOYES
STI-21-7134-7135
14,5 cm

STI-21-7134

STI-21-7135



STI-21-7136

STI-21-7137 STI-21-7138

HFYMANN
STI-21-7136-7138
18 cm

KNIGHT
STI-21-7139
18 cm

BRUENINGS
STI-21-7140-7143
19 cm

STI-21-7140

STI-21-7141

STI-21-7142

STI-21-7143

Scharfe Nasenzangen
 Nasal Cutting Forceps
 Pincès coupantes nasales
 Pinzas cortantes nasales
 Pinze taglienti nasali



LUC
STI-21-7144-7145
 19 cm



LUC
STI-21-7146-7147
 19 cm

ohne Hals
 without neck
 sans cou
 sin cuello
 senza collo



mit Hals
 with neck
 avec cou
 con cuello
 con collo

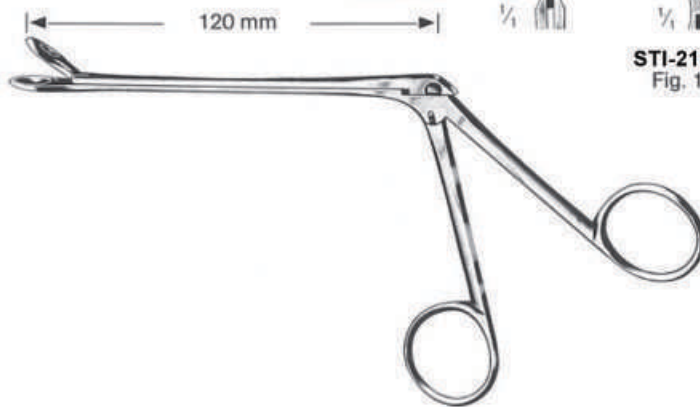

WEIL-BLAKESLEY
STI-21-7148-7157

Scharfe Nasenzangen
Nasal Cutting Forceps
Pinces coupantes nasales
Pinzas cortantes nasales
Pinze taglienti nasali



STI-21-7158-7162
19 cm



STRUYCKEN
STI-21-7158
Fig. 1



STRUYCKEN
STI-21-7159
Fig. 2



STI-21-7160
5 mm

STI-21-7161
7 mm

STI-21-7162
9 mm



MYLES



STI-21-7163



STI-21-7164



STI-21-7165



STI-21-7166



HARTMANN



Septum-Quetschzange
Septum Crushing Forceps
Pince à écraser la cloison
Pinza para magullar tabique
Pinza per ammaccare il setto

RUBIN
STI-21-7167
21 cm



mm x mm	KERRISON
3x3	STI-21-7168
4x4	STI-21-7169
5x5	STI-21-7170
6x6	STI-21-7171
	17 cm



HAJEK-KOFLER
STI-21-7172-7173



mm	STI-21-7174
1,0	STI-21-7175
2,5	STI-21-7176
4,0	STI-21-7177



BEYER
STI-21-7178
 2,0 mm



HAJEK-CLAUS
STI-21-7179
 20 cm



MIDDLETON-JANSEN
STI-21-7180
19 cm



MIDDLETON-JANSEN
STI-21-7181
19 cm



Ø mm	LICHTWITZ
1,5	STI-21-7182
1,8	STI-21-7183
2,0	STI-21-7184
Luer-Lock 10 cm	



KILLIAN
STI-21-7185
14 cm/3 mm Ø



KRAUSE
STI-21-7186
26 cm



WILDE
STI-21-7187
24 cm



STI-21-7188
0,3 mm



JOSEPH
 STI-21-7189-7192



STI-21-7189 STI-21-7190
 stumpf · blunt · mousses
 romos · smussi



STI-21-7191 STI-21-7192
 spitz · pointed · pointus
 puntiagudos · acuti



FREER
 STI-21-7193
 15 cm



FREER
 STI-21-7194
 19 cm



JOSEPH
 STI-21-7195
 16 cm

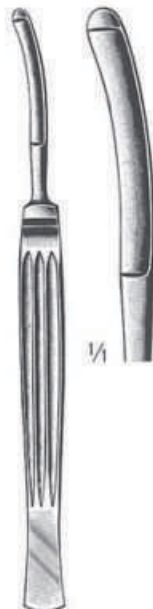

CONVERSE
 STI-21-7196
 16 cm



COTTLE
 STI-21-7197
 15 cm



STI-21-7198



COTTLE
 STI-21-7199



STI-21-7201



BALLENGER
STI-21-7202-7207
20 cm

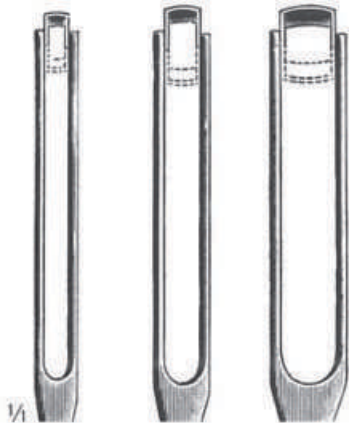

STI-21-7202 3 mm
STI-21-7203 4 mm
STI-21-7204 5 mm

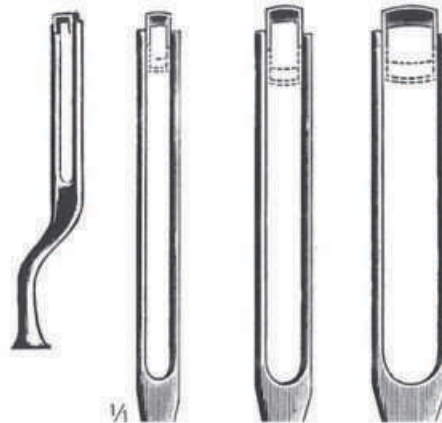

STI-21-7205 3 mm
STI-21-7206 4 mm
STI-21-7207 5 mm



BRUENINGS
STI-21-7208
16,5 cm

Septum-Elevatorien
Septum Elevators
Élévateurs pour la cloison nasale
Elevadores para tabique
Elevatori per setto



McKENTY
STI-21-7209-7210
15 cm



STI-21-7209
4 mm



STI-21-7210
5 mm



ROGER
STI-21-7211
19 cm



FREER
STI-21-7212
18 cm



FREER
STI-21-7213
19 cm



FREER
STI-21-7214
19 cm



COTTLE
STI-21-7215
 23 cm



COTTLE
STI-21-7216
 22 cm



JOSEPH
STI-21-7217
 16 cm



COTTLE
STI-21-7218
 19 cm



KILLIAN
STI-21-7219
 22 cm



HAJEK-BALLENGER
STI-21-7220
 22 cm



BALLENGER
STI-21-7221
 22 cm



FREER
STI-21-7222
 4 mm



FREER
STI-21-7223
 4 mm



COTTLE
STI-21-7224-7227
18 cm



COTTLE
STI-21-7228
18 cm/6 mm

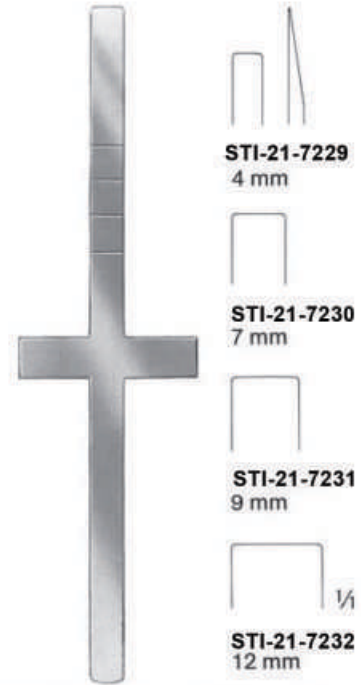

COTTLE
STI-21-7229-7232

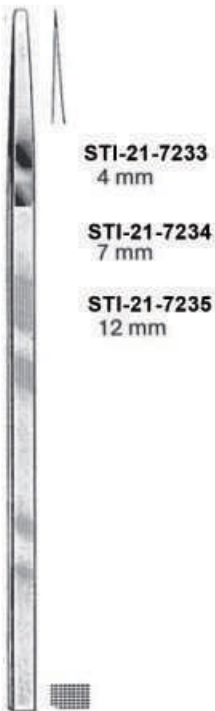

COTTLE
STI-21-7233-7235
18 cm

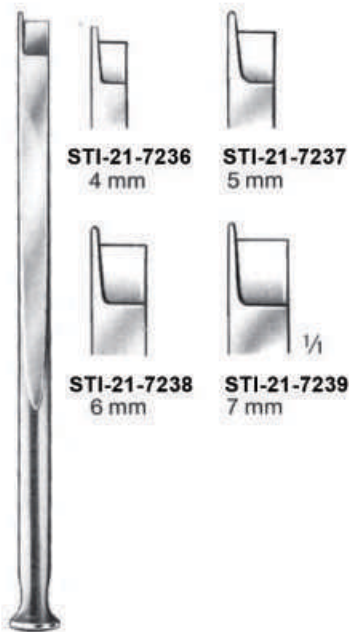

FOMON
STI-21-7236-7239
17 cm

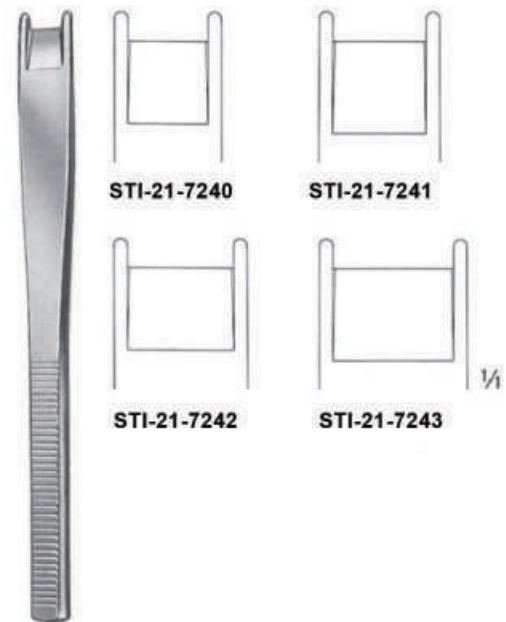

CINELLI
STI-21-7240-7243



SILVER
STI-21-7244
 18 cm

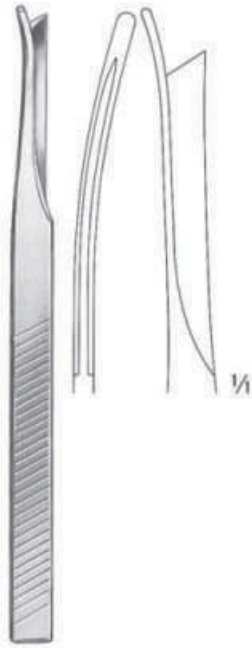

SILVER
STI-21-7245
 18 cm



SILVER
STI-21-7246
 18 cm



KILLIAN-CLAUS
STI-21-7247
 17 cm/5 mm



mm	HAJEK
4	STI-21-7248
6	STI-21-7249
8	STI-21-7250



WEST
STI-21-7251
 16 cm



WEST
STI-21-7252
 16 cm



FREER
STI-21-7253
 6 mm

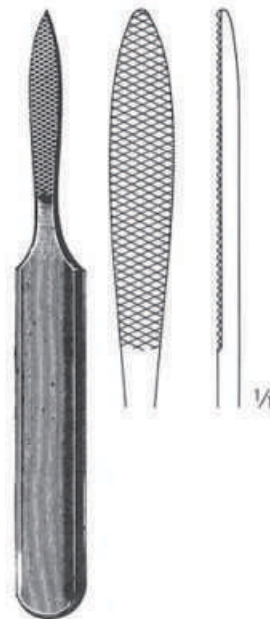

JOSEPH
STI-21-7254
 16 cm

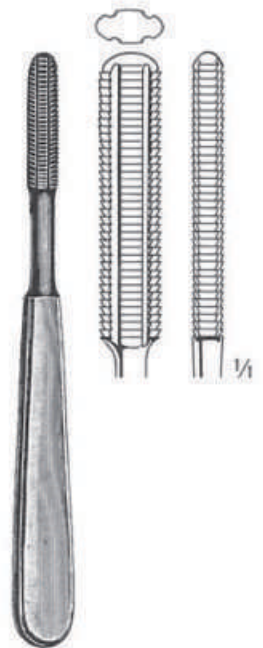

AUFRECHT
STI-21-7255
 18 cm



WIENER
STI-21-7256-7257
18 cm



STI-21-7256



STI-21-7257



WIENER (ALBRECHT)
STI-21-7258-7259
21 cm



STI-21-7258

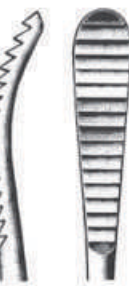

STI-21-7259



JOSEPH (LEWIS)
STI-21-7260-7261
18 cm



STI-21-7260
fein · fine
fina



STI-21-7261
grob · coarse · gruesa
dentellure grosse
dentellatura grossa



MALTZ (COTTLE)
STI-21-7262
21 cm

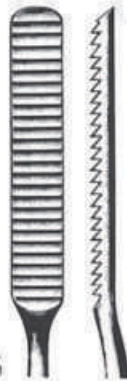

1/4

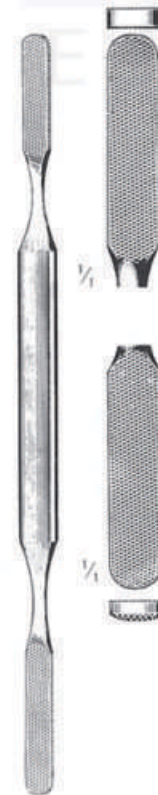

FOMON
STI-21-7263
21 cm



1/4



1/4

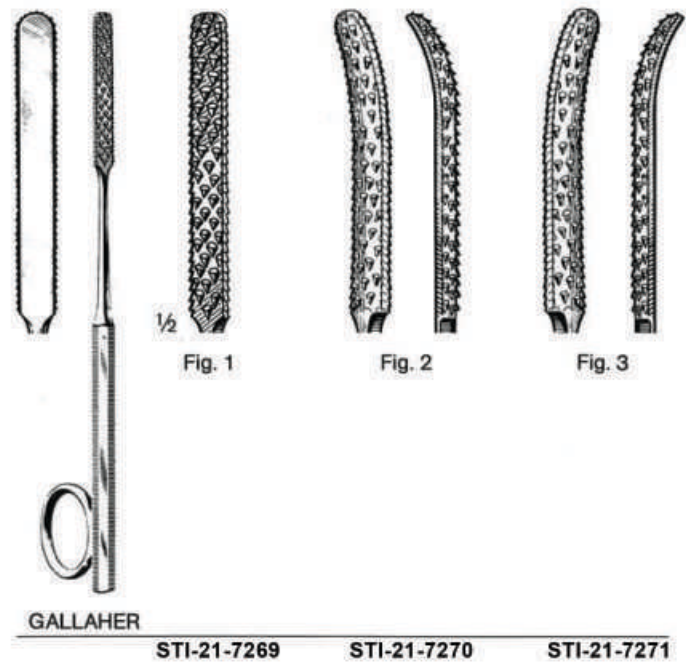
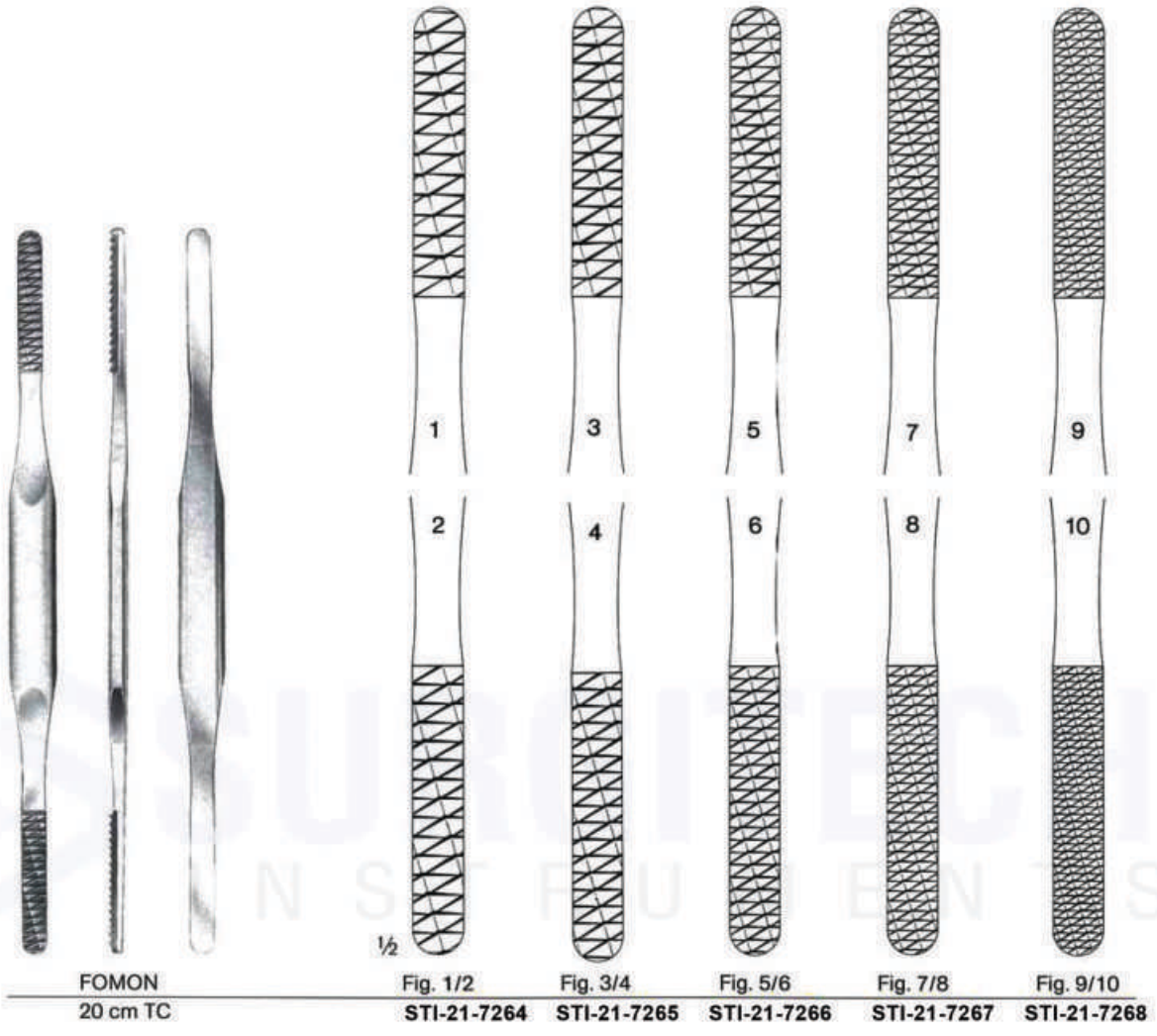



JOSEPH

19 cm **STI-21-7272**
links · left ·
à gauche
izquierda
a sinistra

STI-21-7273
rechts · right ·
à droite
derecha
a destra

JOSEPH
STI-21-7274 17 cm **STI-21-7275**

AUFRICHT
STI-21-7276
19 cm

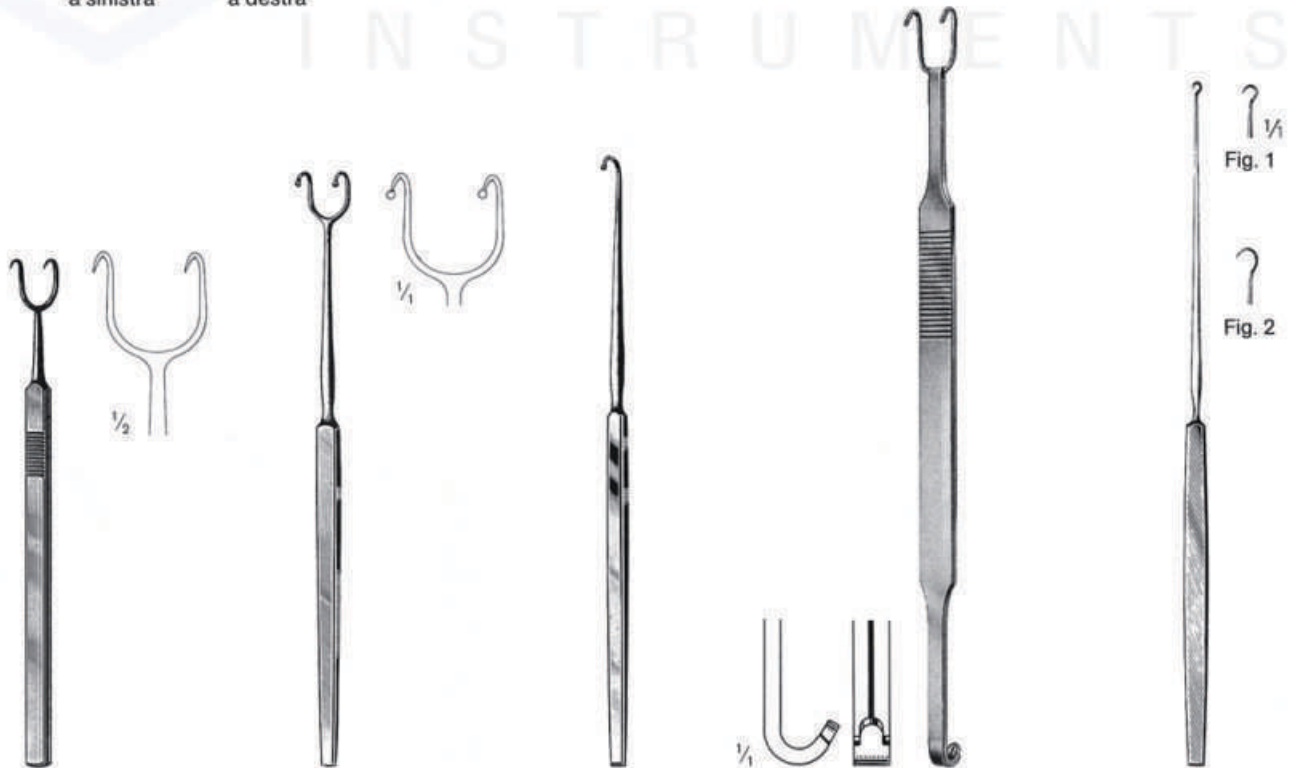

COTTLE
STI-21-7277

FOMON
STI-21-7278

FOMON
STI-21-7279

COTTLE-NEIVERT
STI-21-7280

Fig. 1
GILLIES
STI-21-7281
Fig. 2
STI-21-7282
18 cm

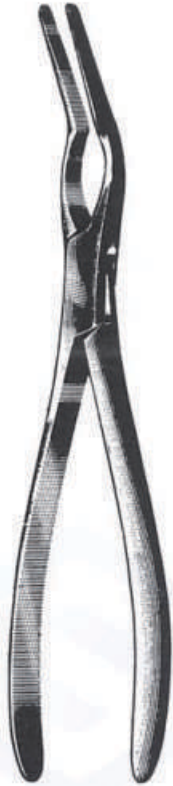

ASCH
STI-21-7283
 23 cm



STI-21-7284
 gerade
 straight
 droite
 recta
 retta

STI-21-7285
 links
 left
 à gauche
 izquierda
 a sinistra

STI-21-7286
 rechts
 right
 à droite
 derecha
 a destra

WALSHAM
STI-21-7284-7286
 23 cm



JATHO
STI-21-7287



FAULKNER
STI-21-7288
 21 cm

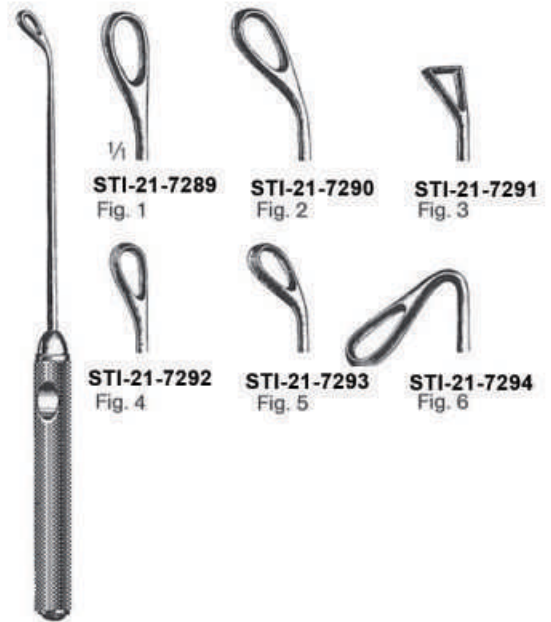

STI-21-7289
 Fig. 1

STI-21-7290
 Fig. 2

STI-21-7291
 Fig. 3

STI-21-7292
 Fig. 4

STI-21-7293
 Fig. 5

STI-21-7294
 Fig. 6

COAKLEY
STI-21-7289-7294
 17 cm



STI-21-7295
Fig. 1



STI-21-7296
Fig. 2



STI-21-7297
Fig. 3



STI-21-7298
Fig. 4



STI-21-7299
Fig. 5



STI-21-7301
Fig. 6

BECKMANN
STI-21-7295-7301
22 cm



STI-21-7302
Fig. 1



STI-21-7303
Fig. 2



STI-21-7304
Fig. 3



STI-21-7305
Fig. 4

BARNHILL
STI-21-7302-7305
21 cm



STI-21-7310
Fig. 1



STI-21-7311
Fig. 2



STI-21-7312
Fig. 3

Ersatzklingen, gelocht
Spare blades, perforated
Lames de rechange, perforées
Hojas de repuesto, perforadas
Lame di ricambio, forate

Fig.	
1	STI-21-7313
2	STI-21-7314
3	STI-21-7315



STI-21-7306
Fig. 1



STI-21-7307
Fig. 3



STI-21-7308
Fig. 2



STI-21-7309
Fig. 4

SL CLAIR-THOMSON
STI-21-7306-7309
21 cm

LAFORCE
STI-21-7310-7315
25 cm

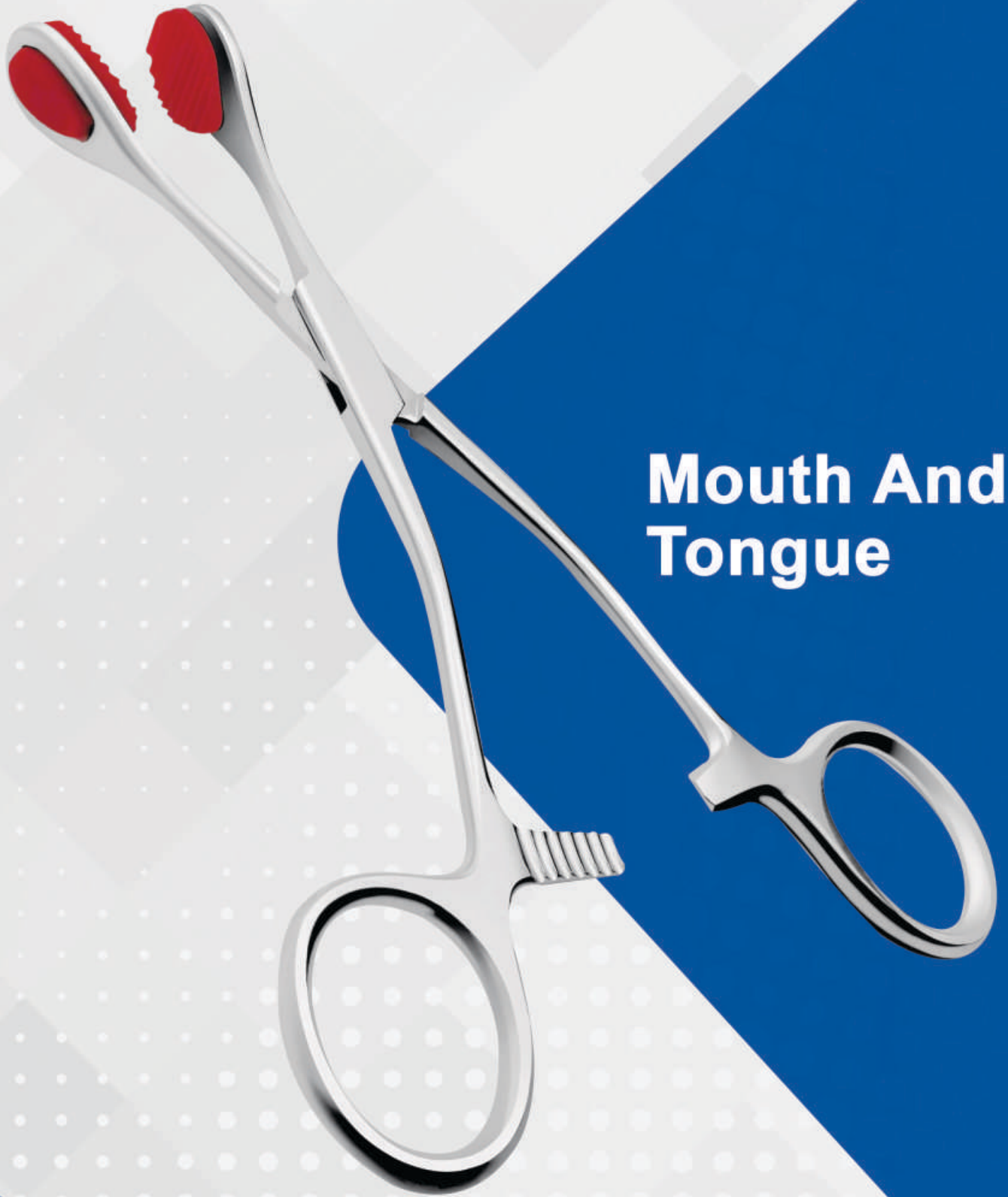

Mouth And Tongue

SURGITECH

Zungenspatel, Lippenhalter
 Tongue Depressors, Lip Retractors
 Abaisse-langue, écarteurs des lèvres
 Abajalengua, Separadores de labios
 Abbassalingua, Divaricatori di labbra



STI-21-7316
 16 cm
 Holz · wood ·
 bois · madera · legno



FRENZEL
STI-21-7317
 16,5 cm



BRUENINGS
STI-21-7318
 19 cm



BUCHWALD
STI-21-7319
 19 cm



HARTMANN
STI-21-7320
 15 cm



STI-21-7321
 Fig. 1, 14 cm

STI-21-7322
 Fig. 2, 15 cm

WIEDER
STI-21-7321-7322



ANDREW
STI-21-7324
 11 cm

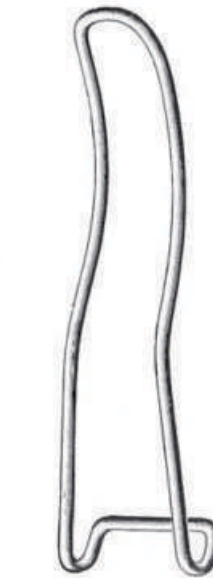

TOBOLD
STI-21-7324
 14,5 cm

cm	STERNBERG
14	STI-21-7325
16	STI-21-7326
18	STI-21-7327



cm	STERNBERG
12	STI-21-7328
14	STI-21-7329
16	STI-21-7330



STI-21-7331
11 cm



STI-21-7332
19 cm

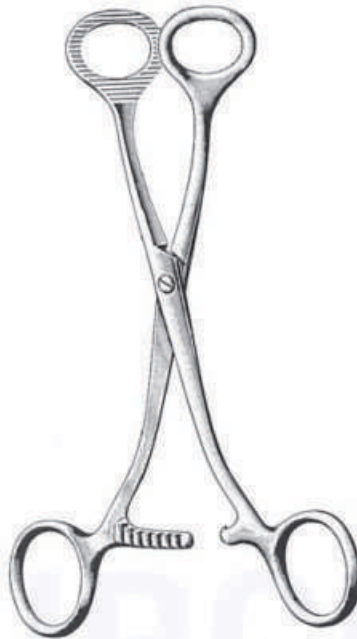

cm	COLLIN
16	STI-21-7333
18	STI-21-7334



48.255.99
Ersatz (Paar)
Spare (Pair)
Rechange (paire)
Repuesto (pareja)
Ricambio (coppia)

YOUNG
STI-21-7335
16 cm

Mundsperrer · Mouth Gags
Ouvre-bouche · Abrebocas
Apribocca



DOYEN-JANSEN (MOLT)
STI-21-7336
12 cm



DOYEN-JANSEN (MOLT)
STI-21-7337
14 cm



DENHART
STI-21-7338
12 cm

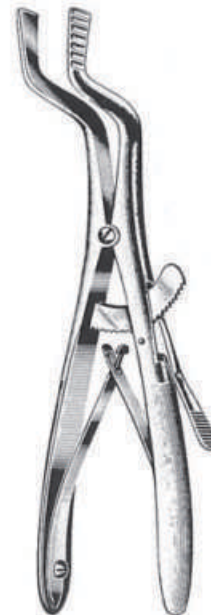

cm	ROSER-KOENIG
16	STI-21-7339
19	STI-21-7340

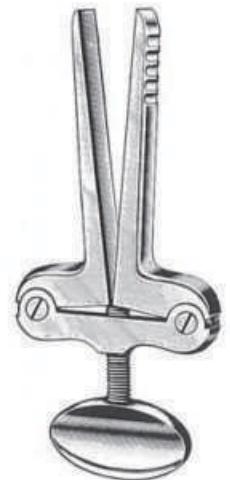

HEISTER
STI-21-7341
13 cm



cm	JENNINGS
9	STI-21-7342
11	STI-21-7343
13	STI-21-7344
15	STI-21-7345



cm	WHITEHEAD
11	EV-21-7346
13	EV-21-7347
15	EV-21-7348

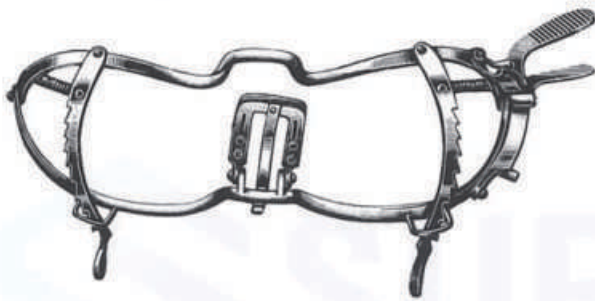

cm	WHITEHEAD
11	STI-21-7349
13	STI-21-7350
15	STI-21-7351



cm	SEEMANN-SEIFFERT
9	STI-21-7352
11	STI-21-7353
13	STI-21-7354
15	STI-21-7355

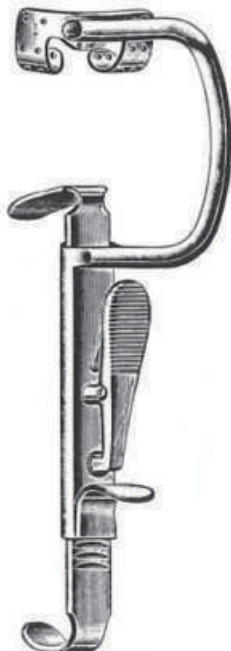

DAVIS-BOYLE
 STI-21-7356



STI-21-7357
 27 x 105 mm Fig. 1

DAVIS-BOYLE
 STI-21-7358
 compl.



STI-21-7359
 25 x 90 mm Fig. 2



STI-21-7360
 25 x 75 mm Fig. 3



STI-21-7361
 22 x 60 mm Fig. 4



STI-21-7362
 20 x 25 mm Fig. 5



STI-21-7363

1/2



STI-21-7364
28 x 65 mm
Fig. 1



STI-21-7365
32 x 75 mm
Fig. 2



STI-21-7366
37 x 80 mm
Fig. 3



STI-21-7367

KILNER-DOUGHTY

STI-21-7368
compl.



STI-21-7369



STI-21-7370
27 x 95 mm
Fig. 1



1/2

STI-21-7371
22 x 85 mm
Fig. 2



STI-21-7372
22 x 70 mm
Fig. 3

McIVOR

STI-21-7373
compl.



MAUNDER
STI-21-7374

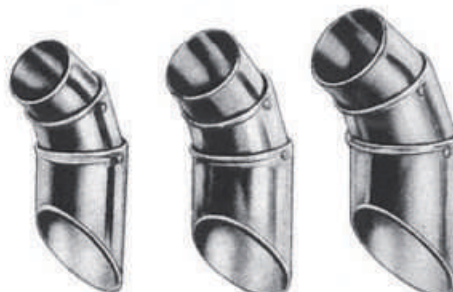

STI-21-7375
Fig. 1

LANGENBECK
STI-21-7376
Fig. 2

STI-21-7377
Fig. 3



links
left side
côté gauche
izquierda
lato sinistro

rechts
right side
côté droit
derecha
lato destro

cm	ROWE	ROWE	
22,5	STI-21-7378	STI-21-7381	Säugling · baby · bébé · bebé · lattante
23,5	STI-21-7379	STI-21-7382	Kinder · child · enfant · niño · bambino
24,0	STI-21-7380	STI-21-7383	Erwachsene · adult



Tonsils

Tonsillen
Tonsils
Amygdales
Amígdalas
Tonsille



mm	LOVE
18	STI-22-7384
20	STI-22-7385
22	STI-22-7386



HOFER
STI-22-7387
24 cm



NAGER
STI-22-7388
23 cm



HURD
STI-22-7389
glatt · smooth · lisse
liso · liscio
22 cm
STI-22-7390
gezahnt · serrated
dentelé · dentado
dentellato
22 cm

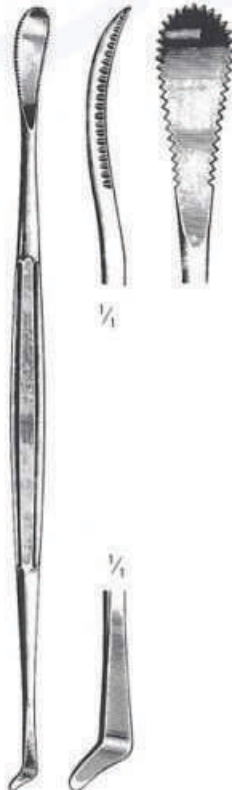

HENKE
STI-22-7391
23 cm



CARPENTER
STI-22-7392
25 cm



CARPENTER
STI-22-7393
24 cm

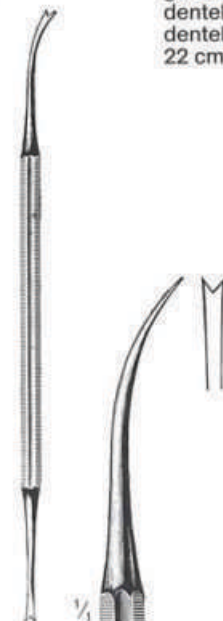

LUNIATSCHEK
STI-22-7394
19 cm



DUPUY-WEISS
STI-22-7395 STI-22-7396
22 cm

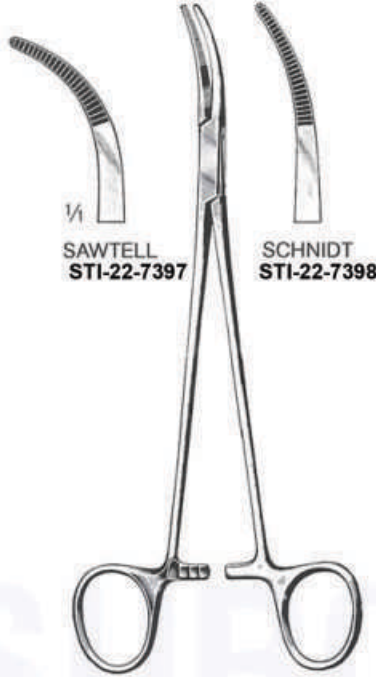

SAWTELL STI-22-7397
SCHNIDT STI-22-7398

STI-22-7397-7398
19 cm

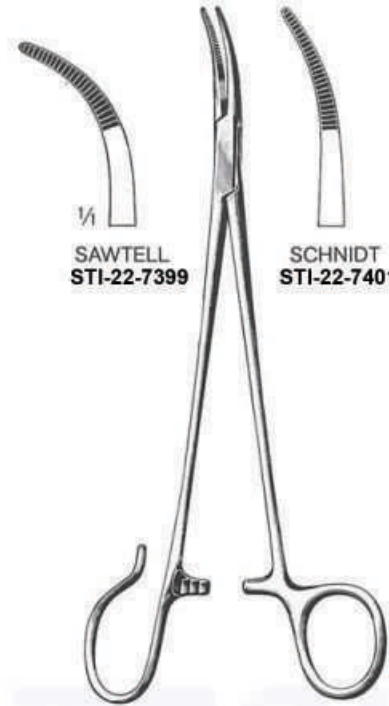

SAWTELL STI-22-7399
SCHNIDT STI-22-7401

STI-22-7399-7401
19 cm

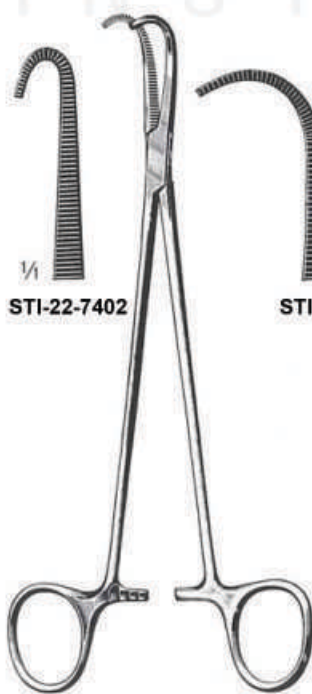

STI-22-7402
STI-22-7403

NEGUS
STI-22-7402-7403
19 cm

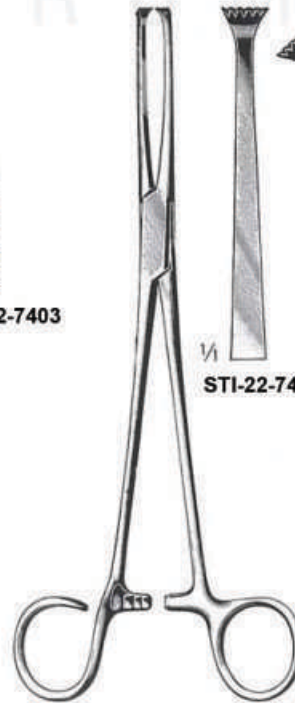

STI-22-7404
STI-22-7405

COLVER
STI-22-7404-7405
19 cm



cm	WHITE
18	STI-22-7406
23	STI-22-7407

Tonsillen
Tonsils
Amygdales
Amigdalas
Tonsille



BALLENGER
STI-22-7408
21,5 cm



BLOHMKE
STI-22-7409
20 cm

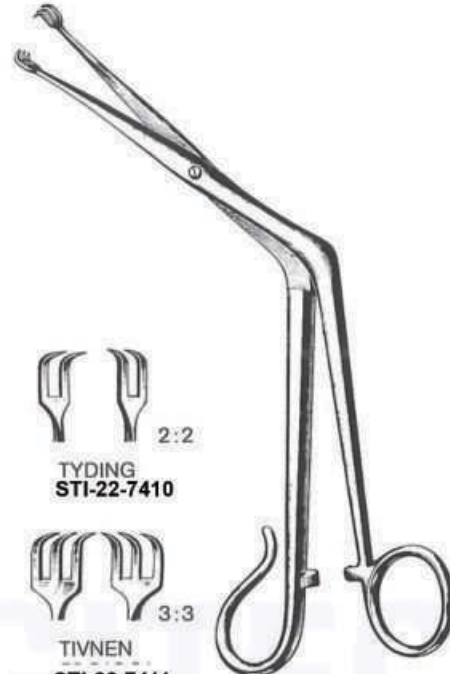

TYDING
STI-22-7410
2:2

TIVNEN
STI-22-7411
3:3

STI-22-7410-7411
21 cm

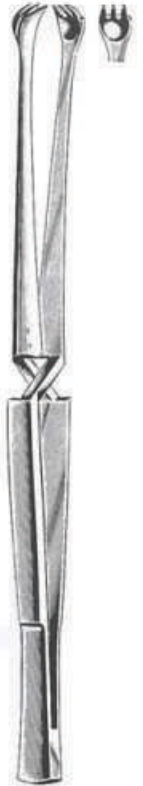

MARSCHIK
STI-22-7412
22 cm



EVES
STI-22-7413
28 cm



EVES
STI-22-7414
28 cm



BRUENINGS
STI-22-7415
28 cm



mm	STI-22-7416	STI-22-7417	STI-22-7418
40			0,3 mm
50			12 x
	100 x		

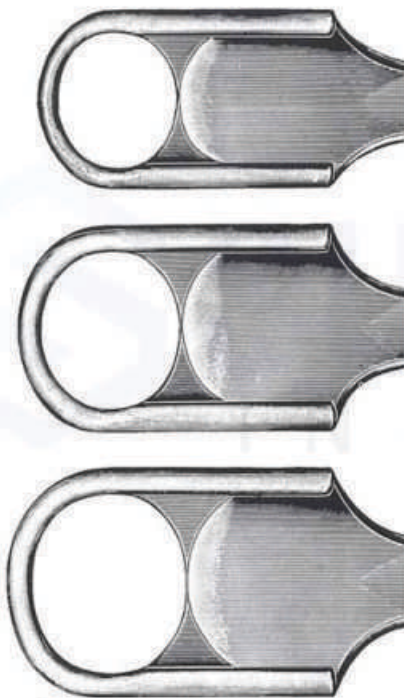

TYDING
STI-22-7419
 mit 1 geraden Aufsatz
 with 1 straight tip
 à 1 embout droit
 con 1 punta recta
 con 1 punta retta

 $\frac{1}{4}$

SLUDER-BALLENGER
STI-22-7420
 mit 3 Aufsätzen
 with 3 blades
 avec 3 lames
 con 3 hojas
 con 3 lame



STI-22-7421



STI-22-7422
 45°



STI-22-7423
 90°

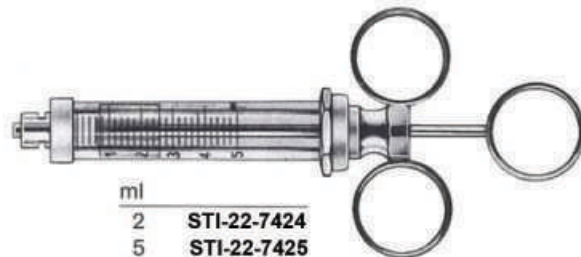

ml	
2	STI-22-7424
5	STI-22-7425
10	STI-22-7426



Larynx



JACKSON
STI-23-7427-7428
22 cm



FRAENKEL
STI-23-7429
18 cm

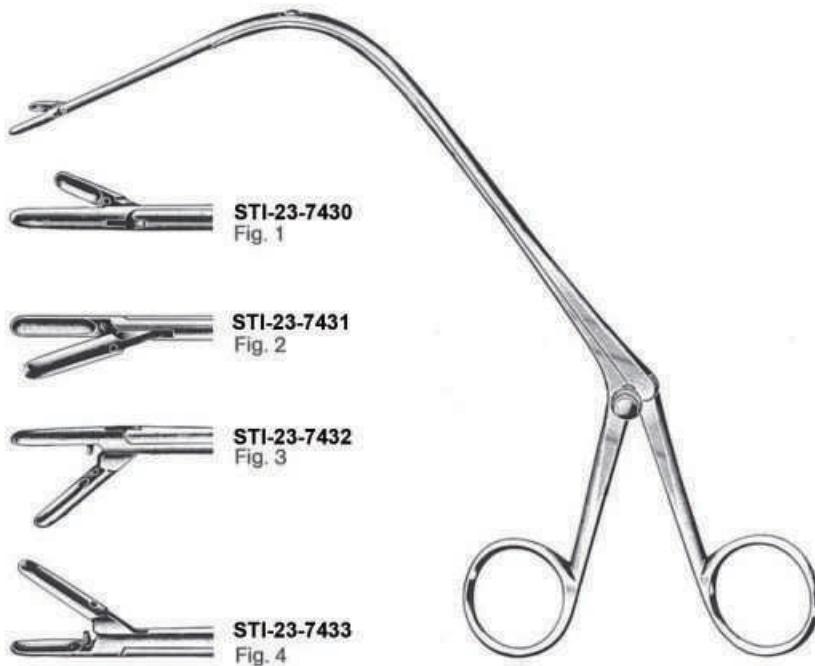

JURASZ
STI-23-7430-7433
23 cm



REICHERT
STI-23-7434
24 cm



HUBER
STI-23-7435



cm	BRUENINGS
20	STI-23-7436
30	STI-23-7437
40	STI-23-7438
50	STI-23-7439
60	STI-23-7440



BRUENINGS
STI-23-7441
20 cm



STI-23-7442
52.150.00



SIFFERT
STI-23-7443



FRANKFI
STI-23-7444



SCHEINMANN
EV-23-7445



SCHEINMANN
STI-23-7446

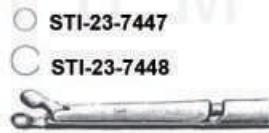

BRUENINGS
STI-23-7447-7448



BRUENINGS
STI-23-7449-7450



LANGE
STI-23-7451



STI-23-7452

STI-23-7453

KRAUSE
STI-23-7452-7453



KRAUSE
STI-23-7454

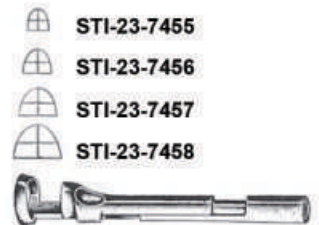

STI-23-7455

STI-23-7456

STI-23-7457

STI-23-7458

CORDES
STI-23-7455-7458



SCHUMACHER
STI-23-7459



STI-23-7460

STI-23-7461

CORDES
STI-23-7460-7461



CORDES
STI-23-7462



ROSENBERG
STI-23-7463

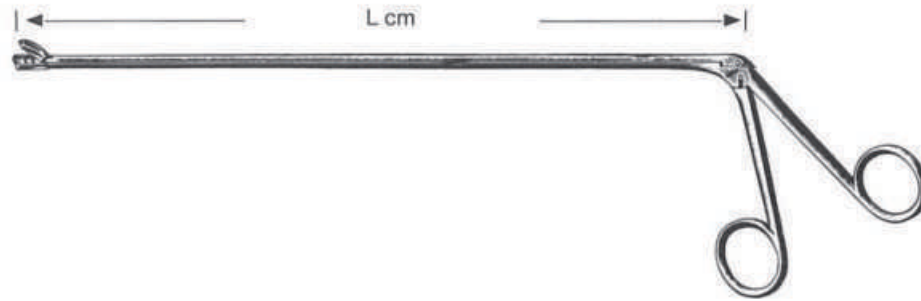

CHEVALIER-JACKSON
STI-23-7464-STI-23-7491

cm	Fig. 1	Fig. 2	Fig. 3	Fig. 4	Fig. 5	Fig. 6	Fig. 7
30	STI-23-7464	STI-23-7465	STI-23-7466	STI-23-7467	STI-23-7468	STI-23-7469	STI-23-7470
40	STI-23-7471	STI-23-7472	STI-23-7473	STI-23-7474	STI-23-7475	STI-23-7476	STI-23-7477
50	STI-23-7478	STI-23-7479	STI-23-7480	STI-23-7481	STI-23-7482	STI-23-7483	STI-23-7484
60	STI-23-7485	STI-23-7486	STI-23-7487	STI-23-7488	STI-23-7489	STI-23-7490	STI-23-7491



Fig. mm Ø

STI-23-7492	00	8	STI-23-7505
STI-23-7493	0	10	STI-23-7506
STI-23-7494	1	12	STI-23-7507
STI-23-7495	2	14	STI-23-7508
STI-23-7496	3	16	STI-23-7509
STI-23-7497	4	18	STI-23-7510
STI-23-7498	5	20	STI-23-7511
STI-23-7499	6	22	STI-23-7512
STI-23-7501	7	24	STI-23-7513
STI-23-7502	8	26	STI-23-7514
STI-23-7503	9	28	STI-23-7515
STI-23-7504	10	30	STI-23-7516

STI-23-7492-7504

STI-23-7505-7516

STI-23-7517

STI-23-7518

Tracheostomy, Goitre



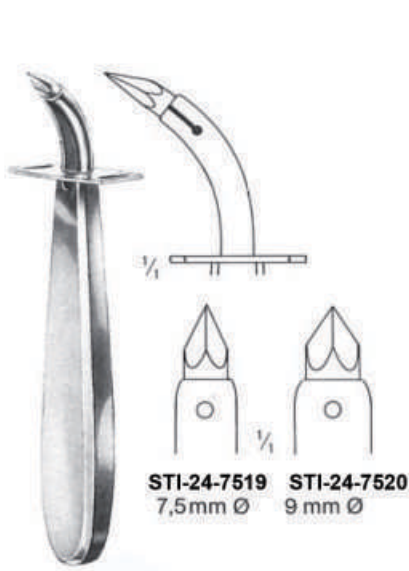

UCKERMANN
STI-24-7519-7520
 13 cm

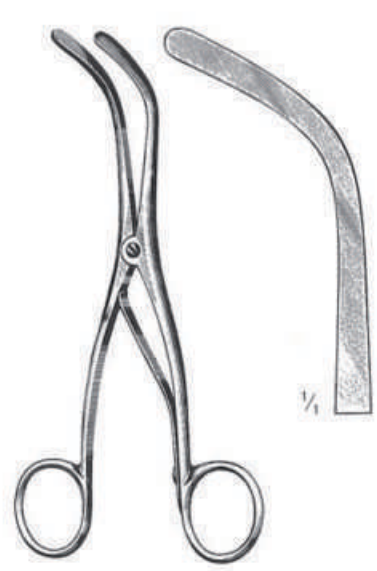

TROUSSEAU
STI-24-7521
 14 cm



LABORDE
STI-24-7522
 14 cm



BOSE
STI-24-7523
 7 cm



JACKSON
STI-24-7524
 15 cm



JACKSON
STI-24-7525
 17 cm



ITERSON
STI-23-7526-7527
 16 cm



BOSE
STI-24-7528
 16 cm



BOSE
STI-24-7529
 16 cm



ROSE
STI-24-7530
13 cm



mm	WAGENER-MOSHER
5	STI-24-7531
7	STI-24-7532
9	STI-24-7533

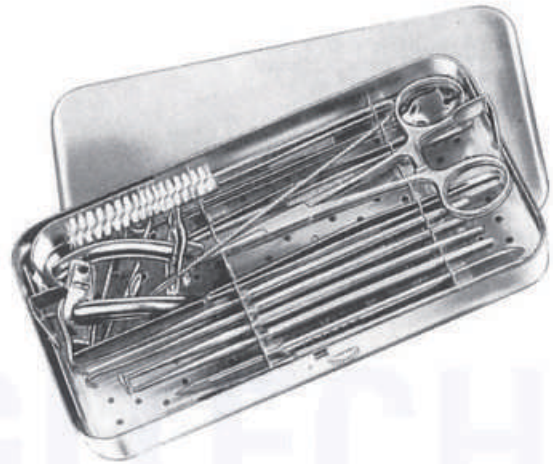

STI-24-7534



Fig.	mm	LUER
0	4	STI-24-7535
1	5	STI-24-7536
2	6	STI-24-7537
3	7	STI-24-7538
4	8	STI-24-7539
5	9	STI-24-7540
6	10	STI-24-7541
7	11	STI-24-7542
8	12	STI-24-7543
9	13	STI-24-7544



Fig.	mm	JACKSON
0	4	STI-24-7545
1	5	STI-24-7546
2	6	STI-24-7547
3	7	STI-24-7548
4	8	STI-24-7549
5	9	STI-24-7550
6	10	STI-24-7551
7	11	STI-24-7552
8	12	STI-24-7553
9	13	STI-24-7554



SURGITECH

Thorax





STI-25-7561
23,0 cm



STI-25-7562
22,0 cm

Rippenschere mit ziehendem Schnitt
Rib shears with drawing cut
Costotome avec lame excentrée
Costótomo con hoja de retroacción
Costotomo con lama eccentrica a scorrimento



GLUCK
STI-25-7563
22,0 cm



STILLE
STI-25-7564
21,0 cm



CORYLLOS
STI-25-7566
35,0 cm

CORYLLOS
STI-25-7565
35,0 cm



BETHUNE
STI-25-7567
34,0 cm



COOLEY
EV-25-7568
35,0 cm



SAUERBRUCH
EV-25-7569
26,0 cm

für die erste Rippe
for the first rib
pour la première côte
para la primera costilla
per la prima costola



GIERTZ-STILLE
STI-25-7570
27,0 cm



SAUERBRUCH-FREY
STI-25-7571
36,0 cm

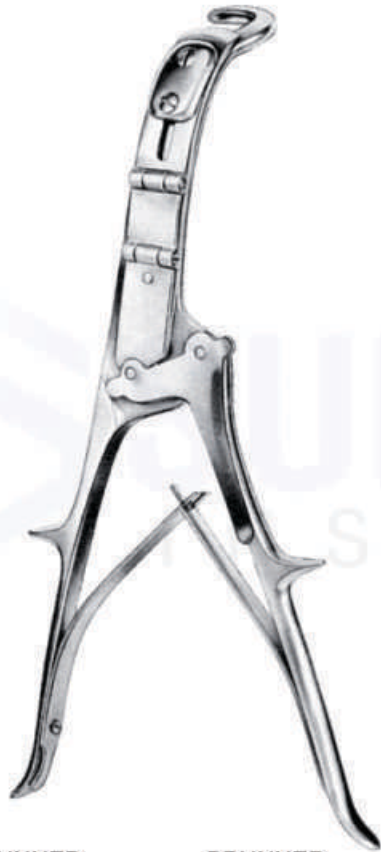

BRUNNER
STI-25-7572
 32,0 cm

für die rechte Hand
 for right hand
 pour la main droite
 para la mano derecha
 per la mano destra

BRUNNER
STI-25-7573
 32,0 cm

für die linke Hand
 for left hand
 pour la main gauche
 para la mano
 izquierda
 per la mano sinistra

Sternum Schere
 Sternum scissors
 Ciseaux a sternum
 Tijera de esternón
 Forbici per sterno



SCHUMACHER
STI-25-7574
 21,0 cm

Blatt · Blade · valve · hoja · valva		
Spreizung Spread Ecartement Abertura Apertura	Tiefe Depth profondité profundidad profondità	Breite Width largeur ancho larghezza
A	B	C



FINOCHIETTO

	A = mm	B = mm	C = mm
STI-25-7575	165 mm	40 mm	40 mm
STI-25-7576	200 mm	45 mm	65 mm
STI-25-7577	250 mm	70 mm	65 mm
STI-25-7578	300 mm	70 mm	65 mm

für Erwachsene · for adults · pour adultes · para adultos · per adulti

ALUMINIUM



FINOCHIETTO (modif.)

	A = mm	B = mm	C = mm
STI-25-7579	120 mm	14 mm	15 mm

für Kinder · for children · pour enfants · para niños · per bambini

Blatt · Blade · valve · hoja · valva		
Spreizung Spread Ecartement Abertura Apertura	Tiefe Depth profondité profundidad profondità	Breite Width largeur ancho larghezza
A	B	C



FINOCHIETTO-BABY

	A = mm	B = mm	C = mm
STI-25-7580	75 mm	18 mm	20 mm

für Säuglinge · for babies · pour bébé · para bebés · per neonati

ALUMINIUM



COOLEY

	A = mm	B = mm	C = mm
STI-25-7581	95 mm	12 mm	13 mm

für Säuglinge · for babies · pour bébé · para bebés · per neonati

COOLEY

	A = mm	B = mm	C = mm
STI-25-7582	140 mm	15 mm	30 mm
STI-25-7583	150 mm	21 mm	44 mm

für Kinder · for children · pour enfants · para niños · per bambini

COOLEY

	A = mm	B = mm	C = mm
STI-25-7584	200 mm	35 mm	50 mm

für Erwachsene · for adults · pour adultes · para adultos · per adulti

Blatt · Blade · valve · hoja · valva		
Spreizung Spread Ecartement Abertura Apertura	Tiefe Depth profondité profundidad profondità	Breite Width largeur ancho larghezza
A	B	C

ALUMINIUM



FINOCHIETTO

	A = mm	B = mm	C = mm
STI-25-7585	135 mm	38 mm	44 mm
STI-25-7586	175 mm	52 mm	62 mm
STI-25-7587	175 mm	85 mm	65 mm

für Erwachsene · for adults · pour adultes · para adultos · per adulti

ALUMINIUM



FINOCHIETTO HAIGHT Baby

	A = mm	B = mm	C = mm
STI-25-7588	100 mm	31 mm	31 mm

für Kinder · for children · pour enfants · para niños · per bambini

Blatt · Blade · valve · hoja · valva		
Spreizung Spread Ecartement Abertura Apertura	Tiefe Depth profondité profundidad profondità	Breite Width largeur ancho larghezza
A	B	C

ALUMINIUM



FINOCHIETTO

	A = mm	B = mm	C = mm
STI-25-7589	100 mm	12 mm	15 mm
STI-25-7590	143 mm	28 mm	30 mm
STI-25-7591	210 mm	31 mm	45 mm
STI-25-7592	245 mm	42 mm	61 mm
STI-25-7593	245 mm	74 mm	64 mm

für Erwachsene · for adults · pour adultes · para adultos · per adulti

Blatt · Blade · valve · hoja · valva		
Spreizung Spread	Tiefe Depth	Breite Width
Ecartement	profondité	largeur
Abertura	profundidad	ancho
Apertura	profondità	larghezza
A	B	C

ALUMINIUM



FINOCHIETTO Infant

	A = mm	B = mm	C = mm
STI-25-7594	75 mm	15 mm	15 mm

für Säuglinge · for babies · pour bébé · para bebés · per neonati

SURGITECH
 INSTRUMENTS



mit 2 Paar Valven
 with 2 pairs of blades
 avec 2 paires de valves
 con 2 pares de valvas
 con 2 paia di valve

FINOCHIETTO BURFORD

	A = mm	B = mm	C = mm
STI-25-7595	210 mm	48/77 mm	64 mm
STI-25-7596	260 mm	48/77 mm	64 mm
STI-25-7597	300 mm	48/77 mm	64 mm

für Erwachsene · for adults · pour adultes · para adultos · per adulti

Blatt · Blade · valve · hoja · valva		
Spreizung Spread	Tiefe Depth	Breite Width
Ecartement	profondité	largeur
Abertura	profundidad	ancho
Apertura	profondità	larghezza
A	B	C



ALUMINIUM

mit 2 Paar Valven
 with 2 pairs of blades
 avec 2 paires de valves
 con 2 pares de valvas
 con 2 paia di valve

FINOCHIETTO BURFORD

	A = mm	B = mm	C = mm
STI-25-7598	180 mm	47/65 mm	62 mm
STI-25-7599	260 mm	47/65 mm	62 mm
STI-25-7601	300 mm	47/65 mm	62 mm

für Erwachsene · for adults · pour adultes · para adultos · per adulti



ALUMINIUM

Blatt · Blade · valve · hoja · valva		
Spreizung Spread	Tiefe Depth	Breite Width
Ecartement	profondité	largeur
Abertura	profundidad	ancho
Apertura	profondità	larghezza
A	B	C

mit 2 Paar Valven
 with 2 pairs of blades
 avec 2 paires de valves
 con 2 pares de valvas
 con 2 paia di valve

FINOCHIETTO BURFORD

	A = mm	B = mm	C = mm
STI-25-7602	135 mm	34/48 mm	42 mm

für Kinder · for children · pour enfants · para niños · per bambini

ALUMINIUM



CASTAÑEDA

	A = mm	B = mm	C = mm
STI-25-7603	65 mm	10,5 mm	32 mm

für Säuglinge · for babies · pour bébé · para bebés · per neonati

CASTAÑEDA

	A = mm	B = mm	C = mm
STI-25-7604	70 mm	12 mm	45 mm

für Kinder · for children · pour enfants · para niños · per bambini

CASTAÑEDA

	A = mm	B = mm	C = mm
STI-25-7605	120 mm	15 mm	60 mm

für Kinder · for children · pour enfants · para niños · per bambini

Blatt · Blade · valve · hoja · valva		
Spreizung	Tiefe	Breite
Spread	Depth	Width
Ecartement	profondité	largeur
Abertura	profundidad	ancho
Apertura	profondità	larghezza
A	B	C



CHEVALIER

	A = mm	B = mm	C = mm
STI-25-7606	190 mm	27 mm	100 mm



HAIGHT

	A = mm	B = mm	C = mm
STI-25-7607	90 mm	30 mm	30 mm
STI-25-7608	115 mm	30 mm	30 mm

Blatt · Blade · valve · hoja · valva		
Spreizung Spread Ecartement Abertura Apertura	Tiefe Depth profundité profundidad profondità	Breite Width largeur ancho larghezza
A	B	C



TUFFIER

	A = mm	B = mm	C = mm
STI-25-7608	165 mm	50 mm	45 mm



Thoraxsperrer
 Thoracic retractor
 Ecarteur thoracique
 Separador torácico
 Divaricatore per il torace



MERCEDES
STI-25-7609

Thoraxsperrer, komplett, bestehend aus:
STI-25-7610 Sperrer
STI-25-7611 Seitenvlaven 42 x 65 mm
STI-25-7612 Seitenvlaven 75 x 75 mm

Thoracic retractor, complete, consisting of:
STI-25-7613 Spreader
STI-25-7614 Lateral blades 42 x 65 mm
STI-25-7615 Lateral blades 75 x 75 mm

Ecarteur thoracique, complet, compuesto de:
STI-25-7616 1 Ecarteur
STI-25-7617 2 Valves latérales 42 x 65 mm
STI-25-7618 2 Valves latérales 75 x 75 mm

Separador torácico, completo, compuesto de:
STI-25-7619 1 Separador
STI-25-7620 2 Valvas laterales 42 x 65 mm
STI-25-7621 2 Valvas laterales 75 x 75 mm

Divaricatore per il torace, completo, composto da:
STI-25-7622 1 Divaricatore
STI-25-7623 2 Valve laterali 42 x 65 mm
STI-25-7624 2 Valve laterali 75 x 75 mm

Blatt · Blade · valve · hoja · valva		
Spreizung Spread Ecartement Abertura Apertura	Tiefe Depth profondité profundidad profondità	Breite Width largeur ancho larghezza
A	B	C



MORSE-FAVOLORO

	A = mm	B = mm	C = mm
STI-25-7625	160 mm	17 mm	22 mm

für Kinder · for children · pour enfants · para niños · per bambini

MORSE-FAVOLORO

	A = mm	B = mm	C = mm
STI-25-7626	200 mm	22 mm	27 mm

für Erwachsene · for adults · pour adultes · para adultos · per adulti



HERTZLER

	A = mm	B = mm	C = mm
STI-25-7627	105 mm	25 mm	25 mm

Rippenkontraktoren
Rib Contractors
Rapprocheurs de côtes
Aproximadores para costillas
Approssimatori costali

Rippensperrer und -Kontraktor
mit drehbaren Klauen

Rib spreader and contractor
with swivel blades

Ecarteur et rapprocheur des côtes
avec valves orientables

Separador y contractor costal
con garras girables

Divaricatore ed approssimatore costale
con valve orientabili

für Kinder
for children
pour enfants;
para niños
per bambini

für Erwachsene
for adults
pour adultes
para adultos
per adulti



SELLORS
STI-25-7628
19,0 cm



BAILEY-BABY
STI-25-7629
15,5 cm



BAILEY
STI-25-7630
20,0 cm



BAILEY-GIBBON
STI-25-7631
20,0 cm

Lungenspatel
 Lung Spatulas
 Spatule pulmonaire
 Espátula para el pulmón
 Spatole per polmone



cm	ALLISON
25,5	STI-25-7632
32,0	STI-25-7633

Lungenfaßzangen
 Lung Grasping Forceps
 Pinces à saisir le poumon
 Pinzas para coger el pulmón
 Pinze per afferrare il polmone



LOVELLACE
STI-25-7634
20,0 cm



LOVELLACE
STI-25-7635
20,0 cm

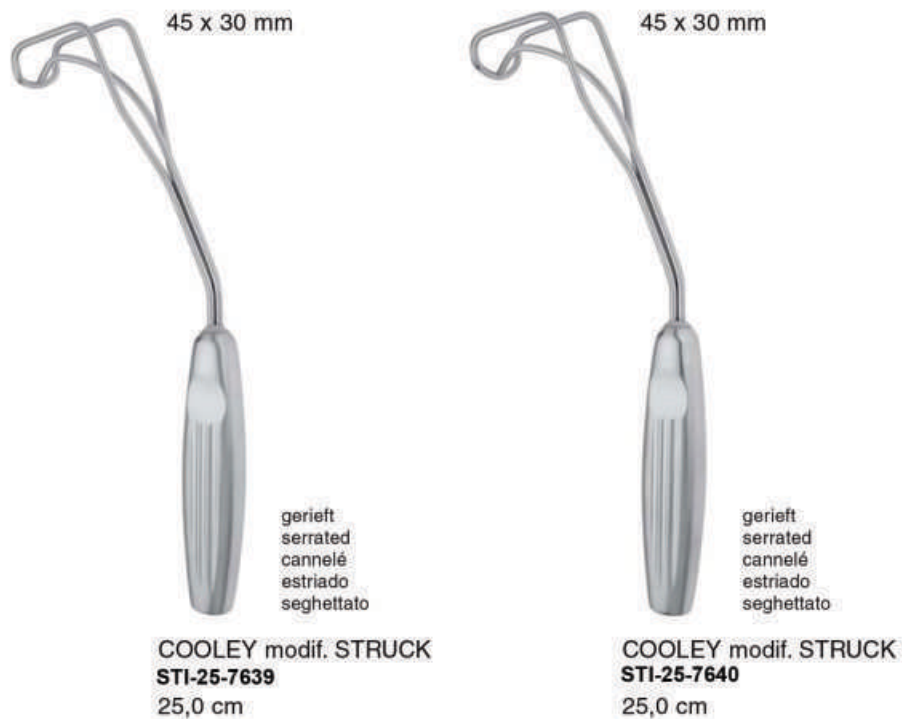
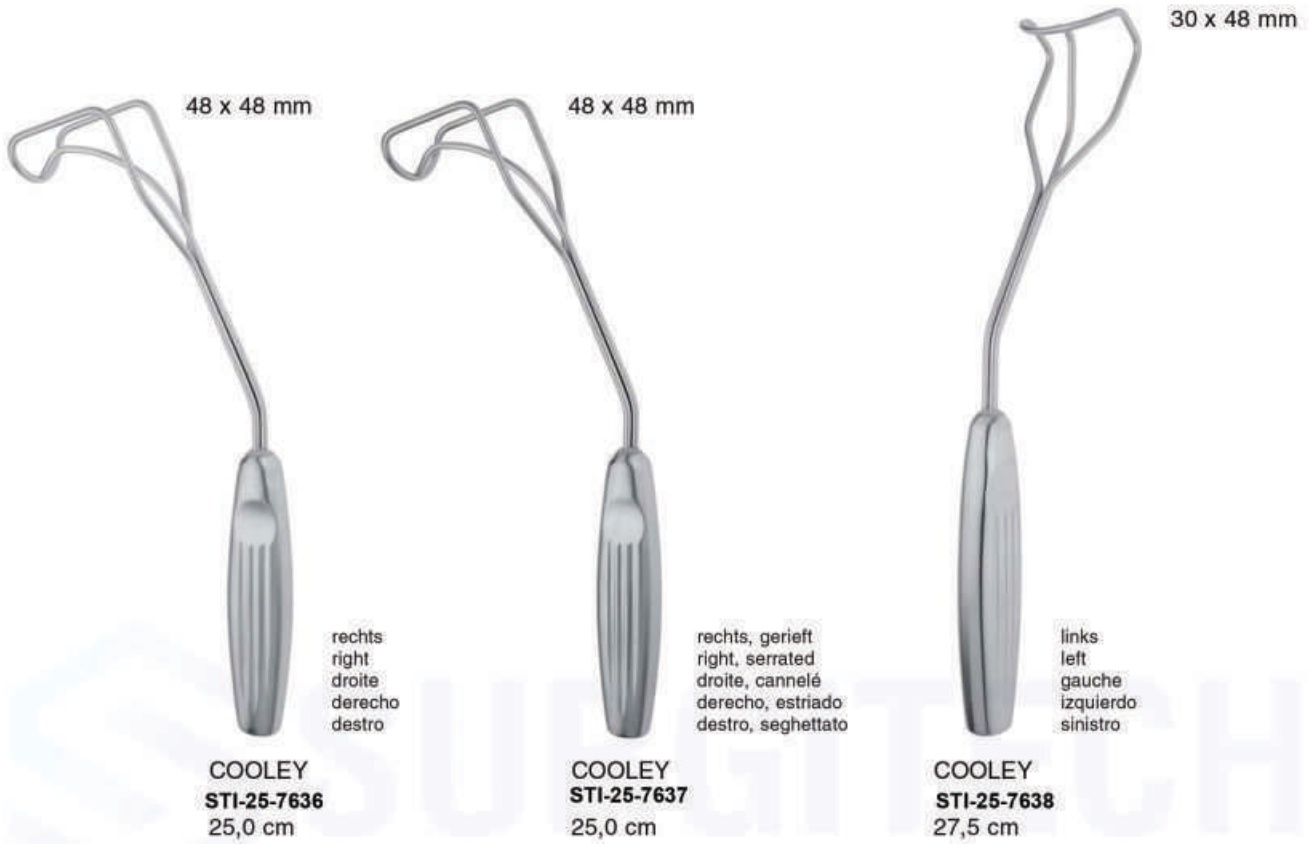

Bronchusklemmen
 Bronchus Forceps
 Pinces-Clamps à Bronches
 Pinzas clamps bronquiales
 Pinze per bronchi



HARRINGTON
STI-25-7641
 30,5 cm

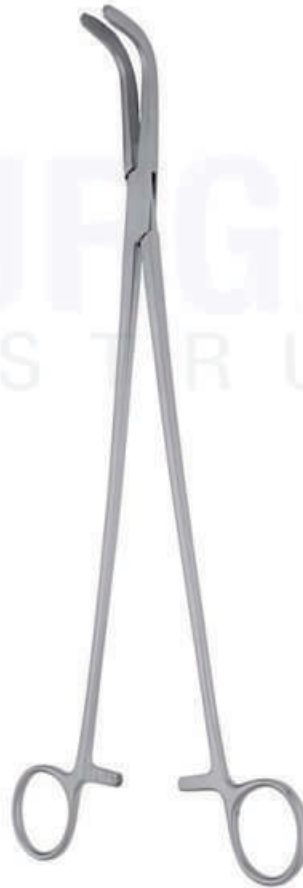

cm **HARRINGTON**
 29,0 **STI-25-7642**
 31,0 **STI-25-7643**



FINOCHIETTO
STI-25-7644
 24,0 cm

Bronchusklemmen
Bronchus Forceps
Pinces-Clamps à Bronches
Pinzas clamps bronquiales
Pinze per bronchi



PRICE-THOMAS
STI-25-7645
22,0 cm



links
left
à gauche
izquierda
sinistra

PRICE-THOMAS
STI-25-7646
22,0 cm



rechts
right
à droite
derecha
destra

PRICE-THOMAS
STI-25-7647
22,0 cm

Bronchusklemmen
Bronchus Forceps
Pinces-Clamps à Bronches
Pinzas clamps bronquiales
Pinze per bronchi



SAROT
STI-25-7648
23,0 cm

SAROT
STI-25-7649
23,0 cm



SAROT

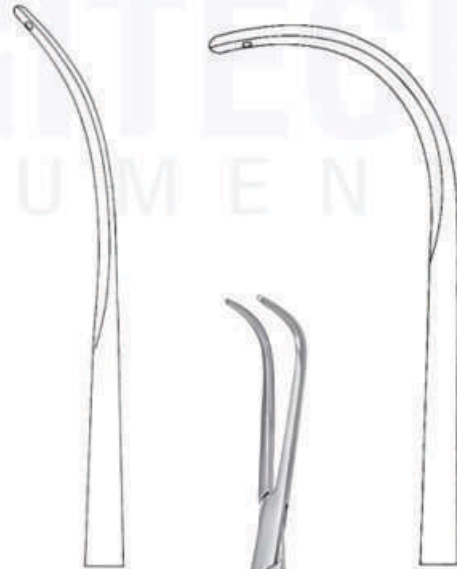

SEMB
STI-25-7650
23,0 cm

SEMB
STI-25-7651
23,0 cm

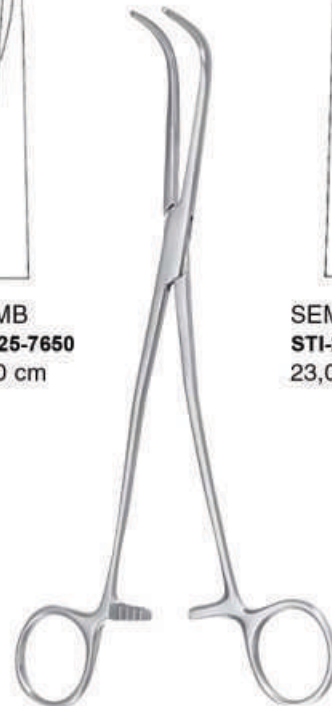

SEMB

Anastomosen- (Vena cava) Klemmen
Anastomosis (Vena Cava) Clamps
Pinces-clamps à anastomose (veine cave)
Pinzas clamps para anastomosis (vena cava)
Pinze per anastomosi (vena cava)



SATINSKY
STI-25-7652
15,0 cm



STI-25-7653
Fig. 1
26,5 cm

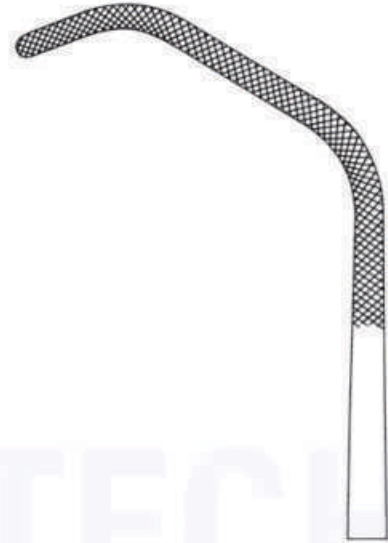

STI-25-7654
Fig. 2
26,5 cm

Anastomosen- (Vena cava) Klemmen
 Anastomosis (Vena Cava) Clamps
 Pincés-clamps à anastomose (veine cave)
 Pinzas clamps para anastomosis (vena cava)
 Pinze per anastomosi (vena cava)



SATINSKY

STI-25-7655
 Fig. 1
 26,5 cm

STI-25-7656
 Fig. 2
 26,5 cm



BROCK
STI-25-7657

Griff allein
Handle only
Manche seul
Mango suelto
Manico solo



BROCK
STI-25-7658

Dilatator Spreizweite 8 - 20 mm
Dilator Opening 8 to 20 mm
Dilatateur ouverture 8 à 20 mm
Dilatador abertura 8 a 20 mm
Dilatatore apertura 8 a 20 mm

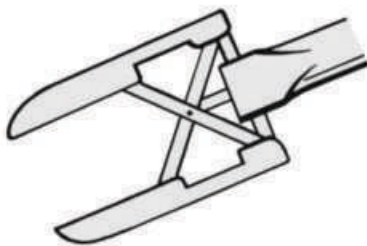

ø mm	BROCK
4,0	STI-25-7659
7,5	STI-25-7660
10,0	STI-25-7661
12,0	STI-25-7662

Stanzen
Punches
Pinzas coupantes
Pinzas cortantes
Pinze taglienti

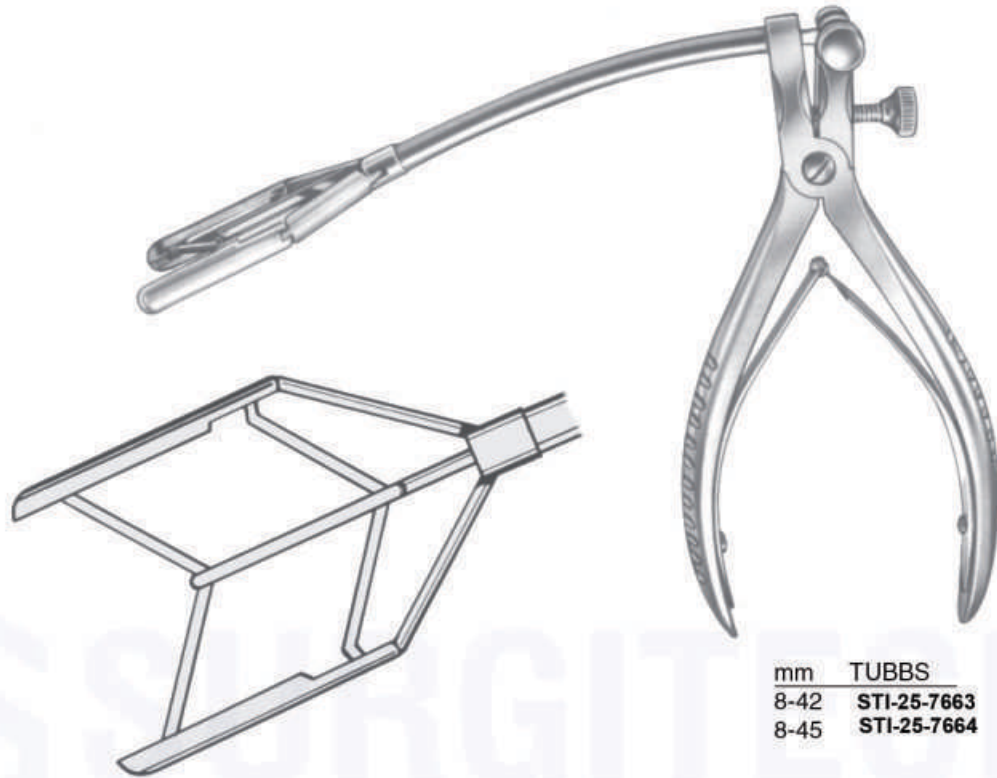

mm	TUBBS
8-42	STI-25-7663
8-45	STI-25-7664

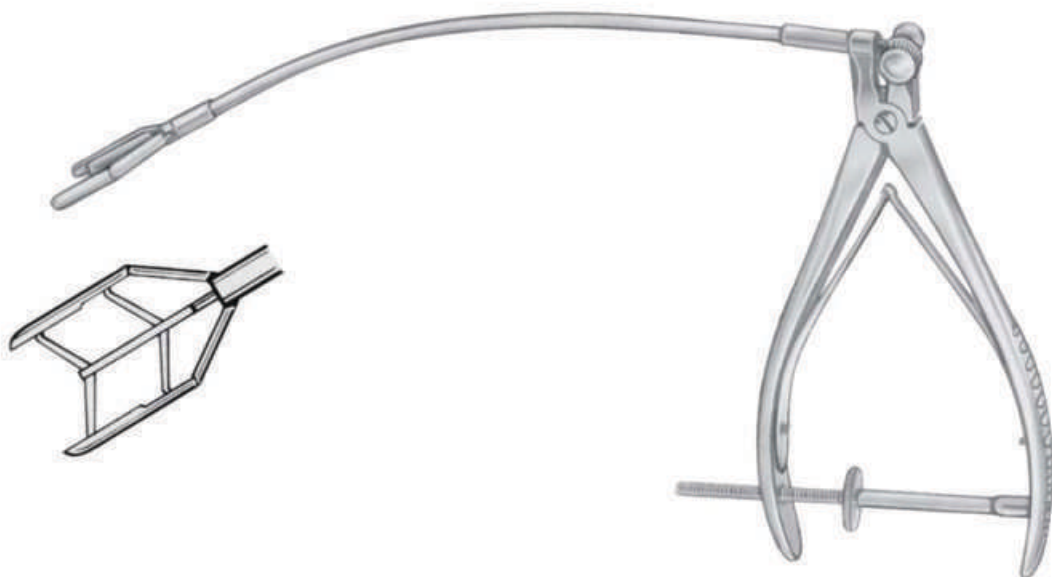

mm	COOLEY
8-15	STI-25-7665
8-45	STI-25-7666

Lunge
Lung
Poumon
Pulmón
Polmone

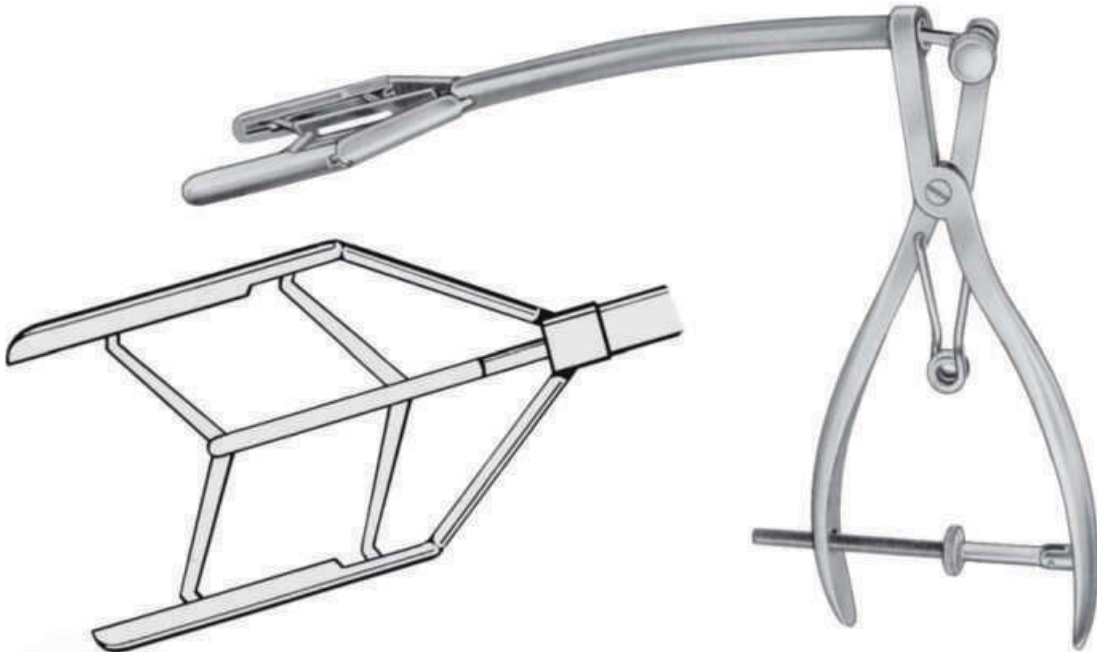

mm GERBODE
9-45 STI-25-7667

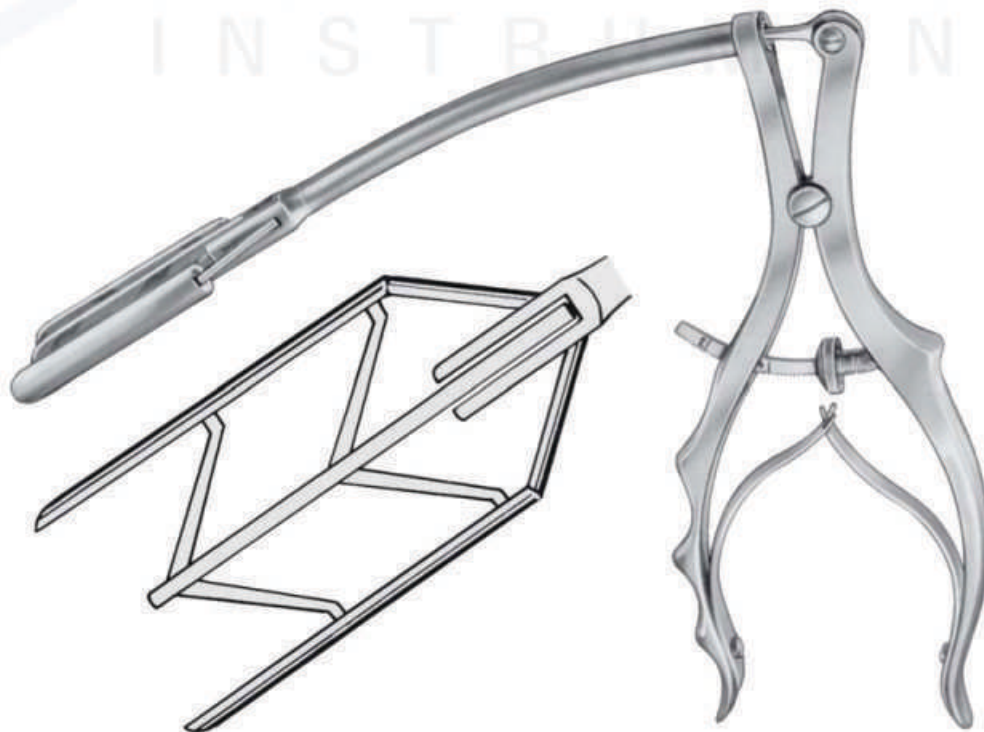

mm COOLEY
7-30 STI-25-7668
9-40 STI-25-7669



mm COOLEY
5-18 STI-25-7670
6-20 STI-25-7671



mm HETZER
4-10 STI-25-7672

biegsam, Silber
malleable, silver
malléables, argent
maleables, silver
maleabili, argento



COOLEY

ø mm	13,0 cm
0,5	STI-25-7673
1,0	STI-25-7674
1,5	STI-25-7675
2,0	STI-25-7676
2,5	STI-25-7677
3,0	STI-25-7678
4,0	STI-25-7679
5,0	STI-25-7680

biegsam
malleable
malléables
maleables
maleabili



DEBAKEY

ø mm	19,0 cm	35,0 cm
0,5	STI-25-7681	STI-25-7693
1,0	STI-25-7682	STI-25-7694
1,5	STI-25-7683	STI-25-7695
2,0	STI-25-7684	STI-25-7696
2,5	STI-25-7685	STI-25-7697
3,0	STI-25-7686	STI-25-7698
3,5	STI-25-7687	STI-25-7699
4,0	STI-25-7688	STI-25-7701
4,5	STI-25-7689	STI-25-7702
5,0	STI-25-7690	STI-25-7703
7,0	STI-25-7691	STI-25-7704
9,0	STI-25-7692	STI-25-7705

Lunge
Lung
Poumon
Pulmón
Polmone

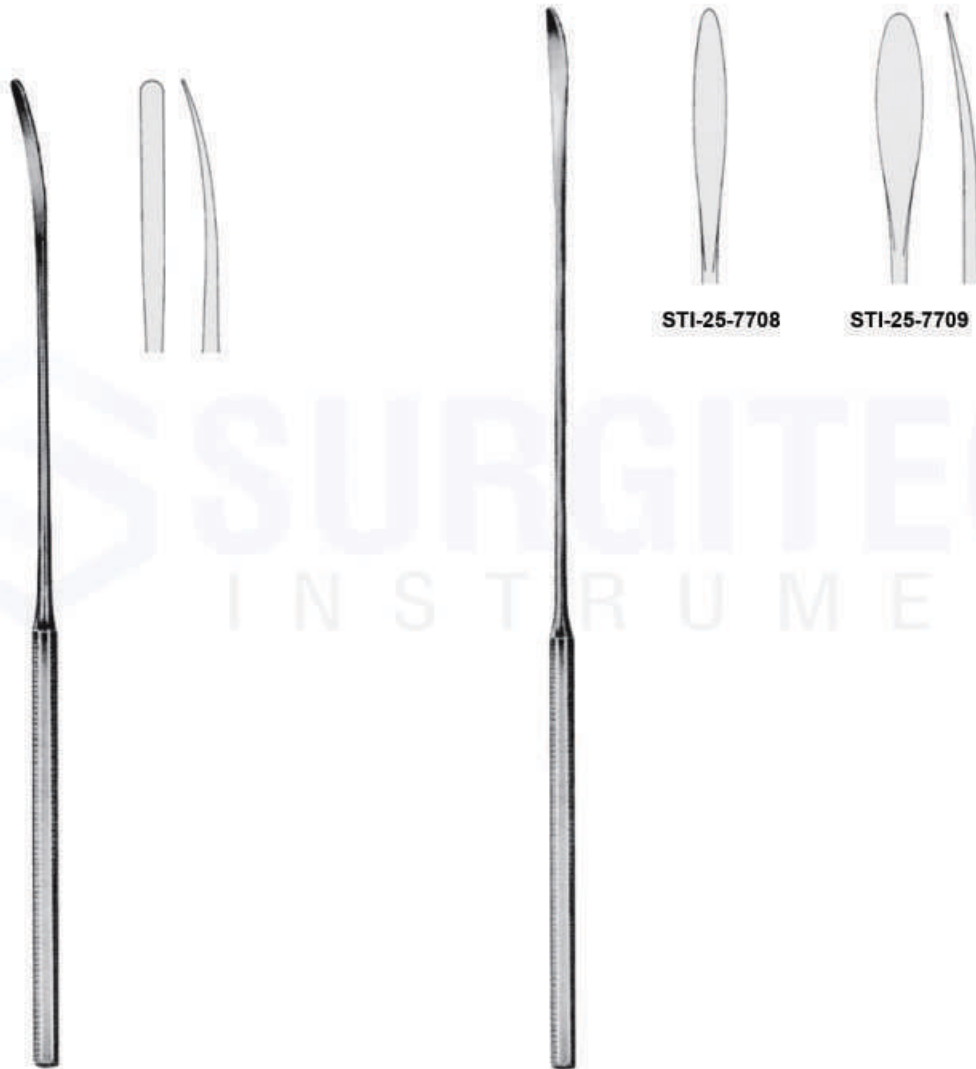

STI-25-7708

STI-25-7709

cm
18,0 STI-25-7706
21,0 STI-25-7707

cm 3 mm
14,0 STI-25-7708
24,0 STI-25-7709



ROBB
STI-25-7710
Fig. 1
24,0 cm



ROBB
STI-25-7711
Fig. 2
24,0 cm



ROBB
STI-25-7712
Fig. 3
24,0 cm



ROBB
STI-25-7713
Fig. 4
24,0 cm

Gall Bladder, Kidney

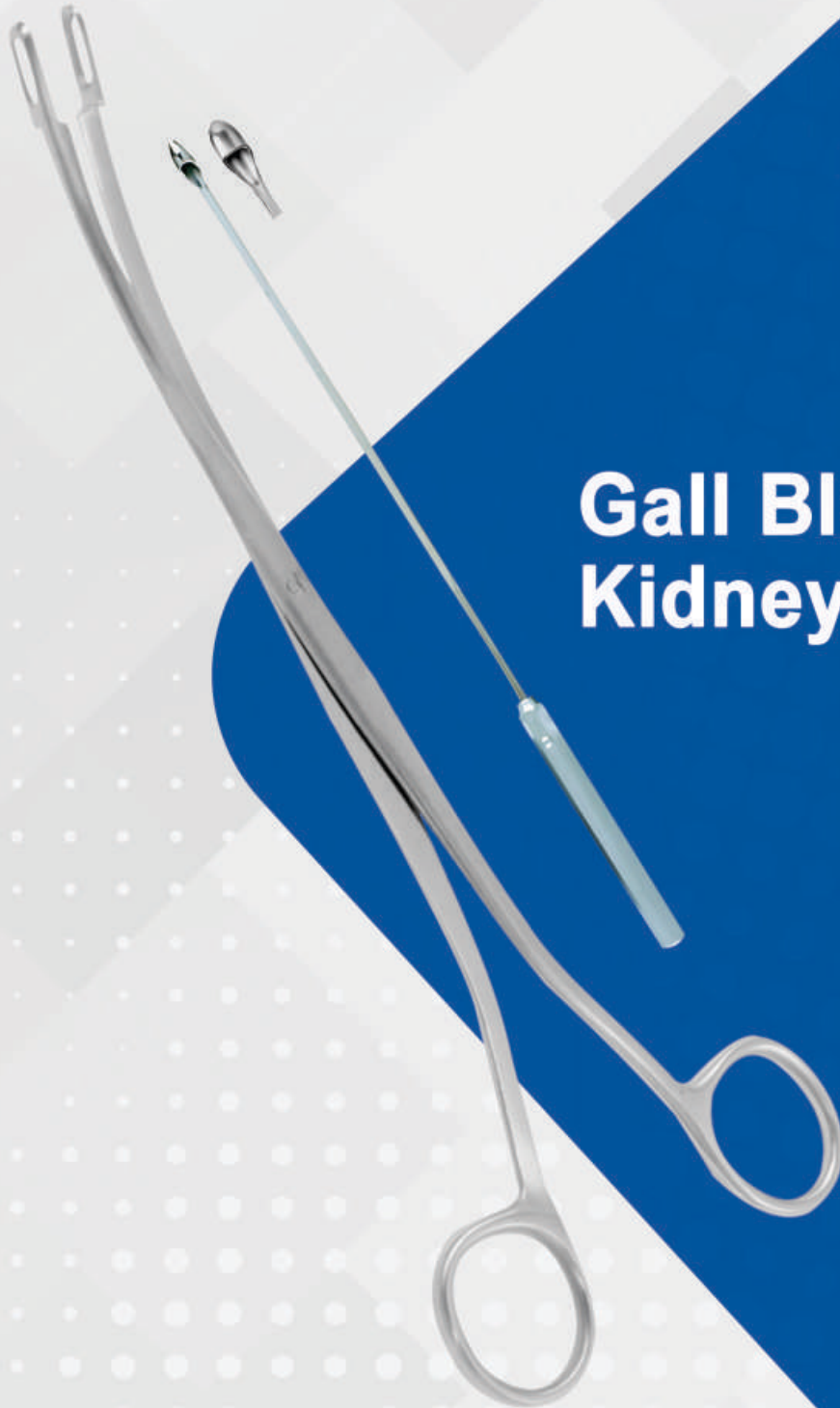

Gallensteinzangen
 Gall Stone Forceps
 Pincés pour calculs biliaires
 Pinzas para cálculos biliares
 Pinze per calcoli biliari

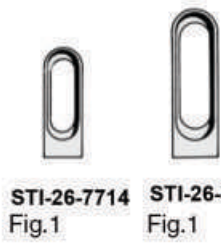

STI-26-7714
 Fig.1

STI-26-7715
 Fig.1

cm	<u>DESJARDINS</u>
23,0	STI-26-7714
23,0	STI-26-7715

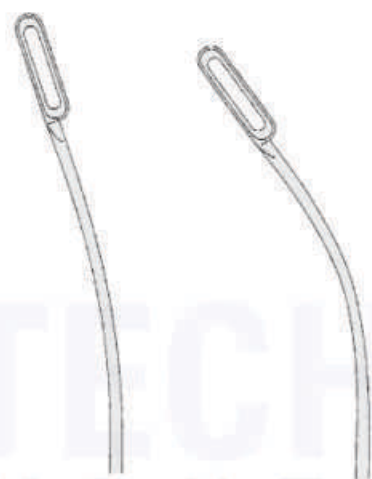

STI-26-7716

STI-26-7717

cm	<u>DESJARDINS</u>
24,0	STI-26-7716
22,5	STI-26-7717

sehr schlankes Modell
 very slender pattern
 modèle très fin
 modelo muy delgado
 modello molto delicato



cm	CZERNY
25,0	STI-26-7718



cm	BLAKE
21,0	STI-26-7720
23,0	STI-26-7721

cm	BLAKE
21,0	STI-26-7719

Gallensteinzangen
Gall Stone Forceps
Pinces pour calculs biliaires
Pinzas para cálculos biliares
Pinze per calcoli biliari



cm MAYO BLAKE
20,0 **STI-26-7722**



cm MAYO BLAKE
20,0 **STI-26-7723**



cm MIXTER
22,0 **STI-26-7724**

Gallensteinlöffel
Gall Stone Scoops
Curettes pour calculs biliaires
Cucharillas para coger cálculos biliares
Cuchhiai per calcoli biliari



cm MOORE
28,0 **STI-26-7725**

federn
elastic
élastiques
elásticas
elastice



STI-26-7726



STI-26-7727



STI-26-7728

cm DESJARDINS
28,0 **STI-26-7726**
28,0 **STI-26-7727**
28,0 **STI-26-7728**

Gallensteinsonde
Gall Stone Probes
Sondes à calculs biliaires
Sondas-exploradoras para cálculos biliares
Sonde per calcoli biliari

biegsam
malleable
souples
maleables
malleabili



cm MOYNIHAN
34,0 **STI-26-7729**

biegsamer Schaft
 malleable shaft
 tige malléable
 västago maleable
 gambo flessibile



BAKES



STI-26-7731
 32 cm
 Fig. 1
 Ø 1 mm



STI-26-7732
 32 cm
 Fig. 2
 Ø 2 mm



STI-26-7733
 32 cm
 Fig. 3
 Ø 3 mm



STI-26-7734
 32 cm
 Fig. 4
 Ø 4 mm



STI-26-7735
 32 cm
 Fig. 5
 Ø 5 mm



EV-26-7736
 32 cm
 Fig. 6
 Ø 6 mm



STI-26-7737
 32 cm
 Fig. 7
 Ø 7 mm



STI-77-2638
 32 cm
 Fig. 8
 Ø 8 mm



STI-26-7739
 32 cm
 Fig. 9
 Ø 9 mm



STI-26-7730
 32 cm
 Fig. 10
 Ø 10 mm



STI-26-7731
 32 cm
 Fig. 11
 Ø 11 mm



STI-26-7732
 32 cm
 Fig. 12
 Ø 12 mm



STI-26-7733
 32 cm
 Fig. 13
 Ø 13 mm

BAKES

STI-26-7730

Satz à 9 Stück in Leinentuchtaschen
 set of 9 pieces in canvas pocket
 jeu de 9 pièces dans une poche en toile
 juego de 9 unidades en bolsa de tela
 set di 9 pezzi

62.150.03 - 62.150.11



cm	FERGUSSON
21,5	STI-26-7734



cm	MAYO
28,0	STI-26-7735



cm	MAYO
27,0	STI-26-7736
27,0	STI-26-7737
27,0	STI-26-7738

Gallensteinlöffel
Gall Stone Scoops
Curettes pour calculs biliaries
Cucharas para cálculos biliaries
Pinze per calcoli biliari



federnd
elastic
élastiques
elásticas
elastice



STI-26-7739



STI-26-7740



STI-26-7741



STI-26-7742

cm	DESJARDINS
30,0	STI-26-7739
30,0	STI-26-7740
30,0	STI-26-7741
30,0	STI-26-7742

biegsam
 malleable
 souples
 maleables
 malleabili

STI-26-7743
 32 cm
 Fig. 000

STI-26-7744
 32 cm
 Fig. 00

STI-26-7745
 32 cm
 Fig. 0

STI-26-7746
 32 cm
 Fig. 1

STI-26-7747
 32 cm
 Fig. 2

STI-26-7748
 32 cm
 Fig. 3

STI-26-7749
 32 cm
 Fig. 4

STI-26-7750
 32 cm
 Fig. 5

Fig	mm	LUER-KOERTE
000	Ø 2,5	STI-26-7743
00	Ø 3,2	STI-26-7744
0	Ø 4,2	STI-26-7745
1	Ø 5,5	STI-26-7746
2	Ø 6,7	STI-26-7747
3	Ø 8,0	STI-26-7748
4	Ø 11,0	STI-26-7749
5	Ø 15,0	STI-26-7750

Ureterklemmen
Ureter Clamps
Pincés-clapms uretère
Pinzas clamps para ureter
Pinze per uretere



cm MAYO
32,0 STI-26-7751



cm LURZ
21,0 STI-26-7752



cm LURZ
21,0 STI-26-7753

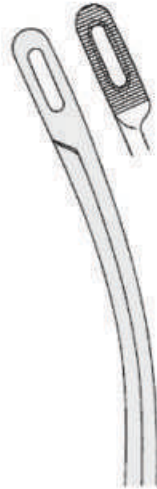

STI-26-7754
23 cm
Fig. 1

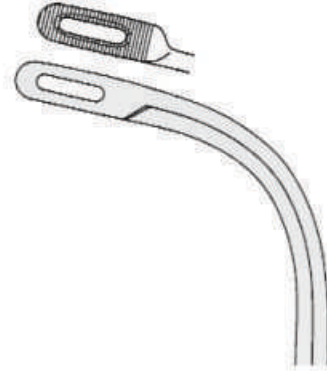

STI-26-7755
21 cm
Fig. 2

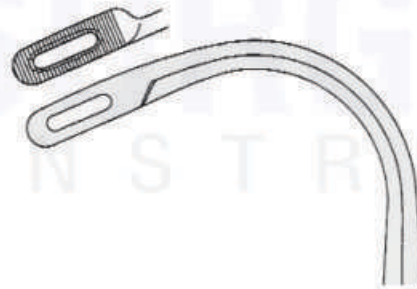

STI-26-7756
19 cm
Fig. 3

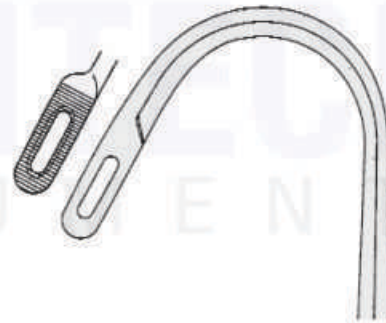

STI-26-7757
18,5 cm
Fig. 4

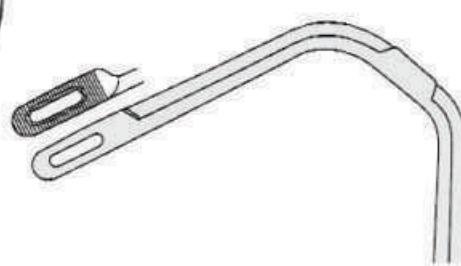

STI-26-7758
19 cm
Fig. 5

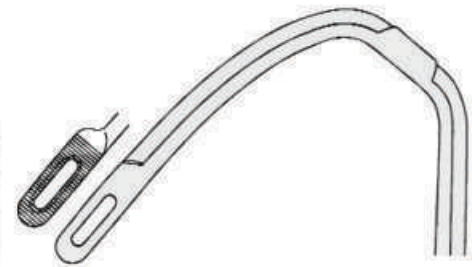

STI-26-7759
19 cm
Fig. 6

Fig.	RANDALL
1	STI-26-7754
2	STI-26-7755
3	STI-26-7756
4	STI-26-7757
5	STI-26-7758
6	STI-26-7759

feines Modell
delicate pattern
modèle délicat
modelo fino
modello delicato

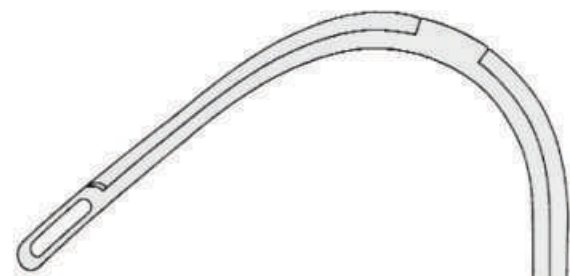

STI-26-7760
23 cm
Fig. 1

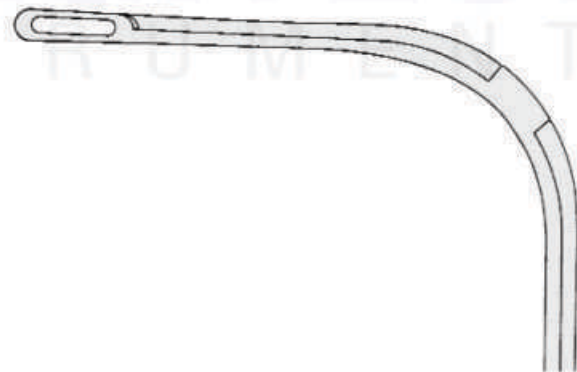

STI-26-7761
24,5 cm
Fig. 2

Fig.	RANDALL
1	STI-26-7760
2	STI-26-7761

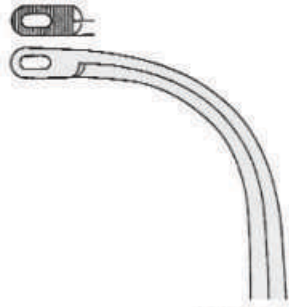

STI-26-7762
16 cm
Fig. 1

Nierenfistelzangen
Nephrostomy Forceps
Pincès à néphrostomie
Pinzas para nefrostomia
Pinze per nefrostomia



STI-26-7764
21 cm
Fig. 1

für Kinder
for children
pour enfants
para niños
per bambini

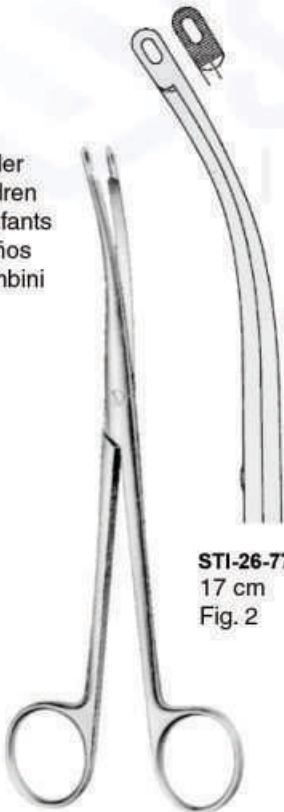

STI-26-7763
17 cm
Fig. 2



STI-26-7765
21 cm
Fig. 2

Fig. HEIMING
1 **STI-26-7762**
2 **STI-26-7763**

Fig. ELSAESSER
1 **STI-26-7764**
2 **STI-26-7765**



Intestines and Stomach

Darm- und Gewebefaßzangen
 Bowel and Tissue Grasping Forceps
 Pincés à saisir les intestins et les tissus
 Pinzas para coger intestinos y tejidos
 Pinze per afferrare intestini e tessuti



ALLIS-Baby
STI-27-7766
 14 cm



4:5	ALLIS	5:6
STI-27-7767	15 cm	STI-27-7768
	19 cm	STI-27-7769
	22 cm	STI-27-7770
	24 cm	STI-27-7771

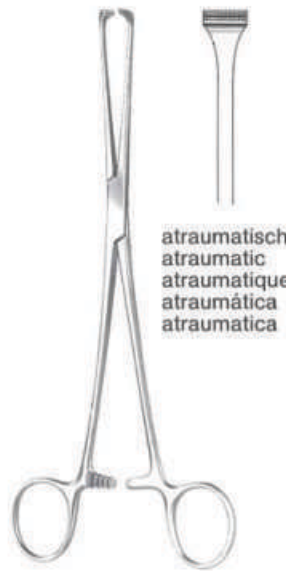

atraumatisch
 atraumatic
 atraumatique
 atraumática
 atraumatica

cm	ALLIS
16	STI-27-7772
20	STI-27-7773
25	STI-27-7774



ALLIS-ADAIR
STI-27-7775
 15,5 cm



cm	JUDD-ALLIS
15	STI-27-7776
19	STI-27-7777



THOMS-ALLIS
STI-27-7778
 20 cm

Mit TC-Einsätzen
 TC Lined
 A mors TC
 Con bocas TC
 Con morso TC



atraumatisch
 atraumatic
 atraumatique
 atraumática
 atraumatica

cm	BABCOCK	TC
16	STI-27-7779	STI-27-7783
18	STI-27-7780	
20	STI-27-7781	STI-27-7784
24	STI-27-7782	

Mit TC-Einsätzen
TC Lined
A mors TC
Con bocas TC
Con morso TC



DUVAL
13 mm



DUVAL
25 mm

cm	
18	STI-27-7787
20	STI-27-7788
20	STI-27-7789
23	

	STI-27-7790
	STI-27-7791



DUVAL
STI-27-7787-7791



WILLIAMS
STI-27-7792
16,5 cm



SCHOENBURG
STI-27-7793
22 cm

STI-27-7791

Darmklemmen
Intestinal Forceps
Pinces intestinales
Pinzas intestinales
Pinze intestinali



DOYEN
DOYEN-Baby
STI-27-7794-7807



cm DOYEN-Baby

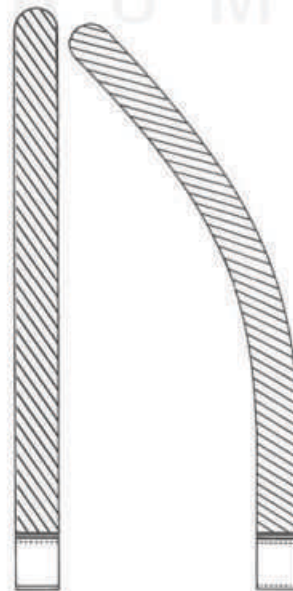

DOYEN

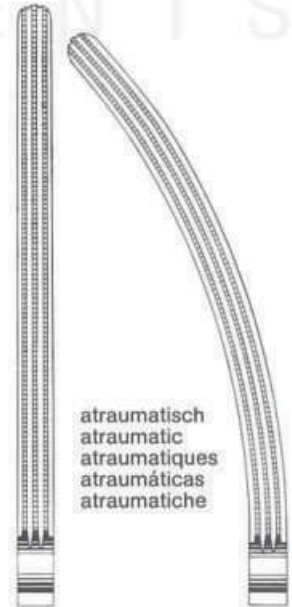

atraumatisch
atraumatic
atraumáticas
atraumáticas
atraumatiche

DOYEN

16	STI-27-7794	STI-27-7795			STI-27-7799	STI-27-7804
18					STI-27-7801	STI-27-7805
21			STI-27-7796	STI-27-7797	STI-27-7802	STI-27-7806
23			STI-27-7797	STI-27-7798	STI-27-7803	STI-27-7807

Darmklemmen
 Intestinal Forceps
 Pincas intestinales
 Pinzas intestinales
 Pinze intestinali

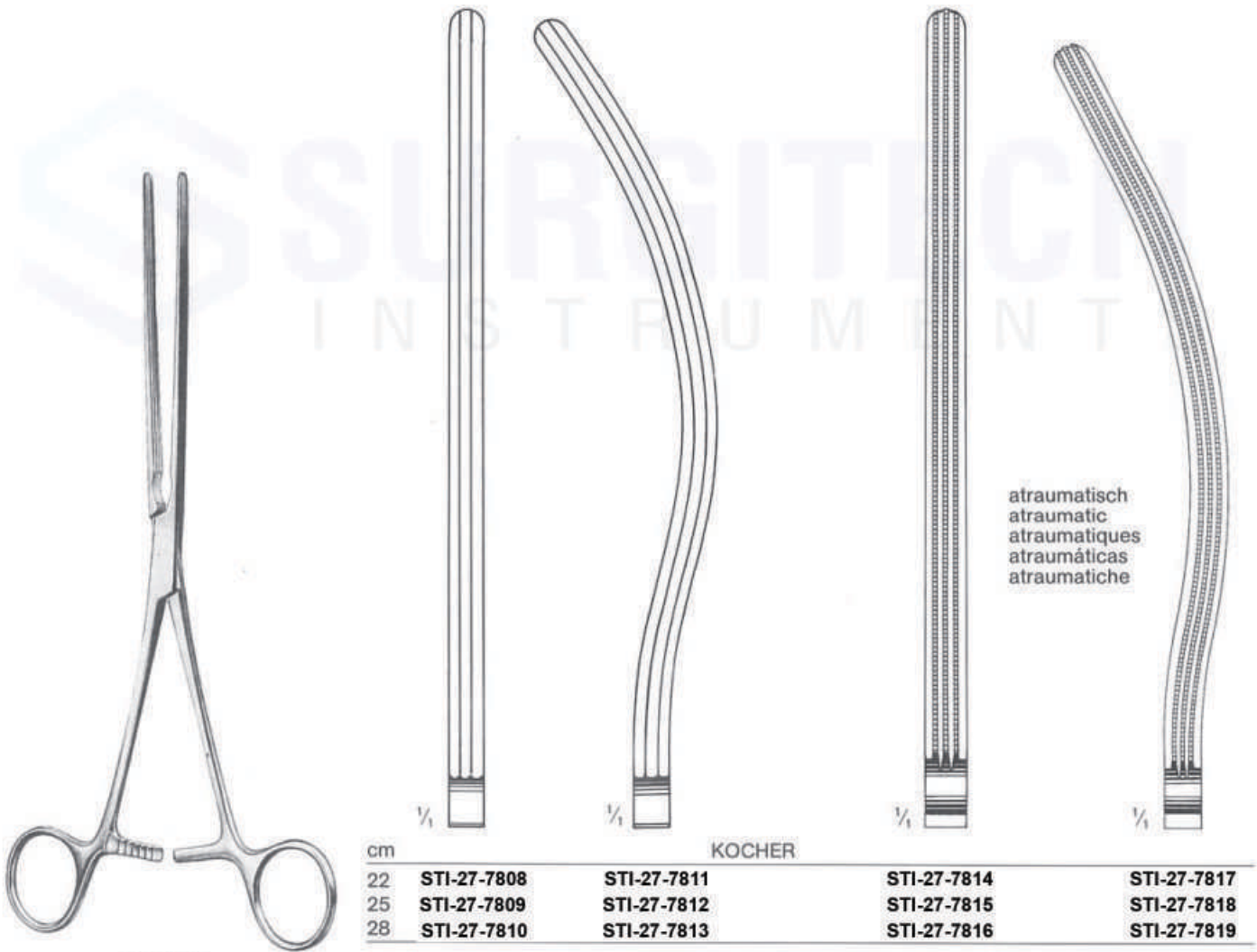

KOCHER
 STI-27-7808-7819

cm	KOCHER			
22	STI-27-7808	STI-27-7811	STI-27-7814	STI-27-7817
25	STI-27-7809	STI-27-7812	STI-27-7815	STI-27-7818
28	STI-27-7810	STI-27-7813	STI-27-7816	STI-27-7819

Darmklemmen
Intestinal Forceps
Pincas intestinales
Pinzas intestinales
Pinze intestinali

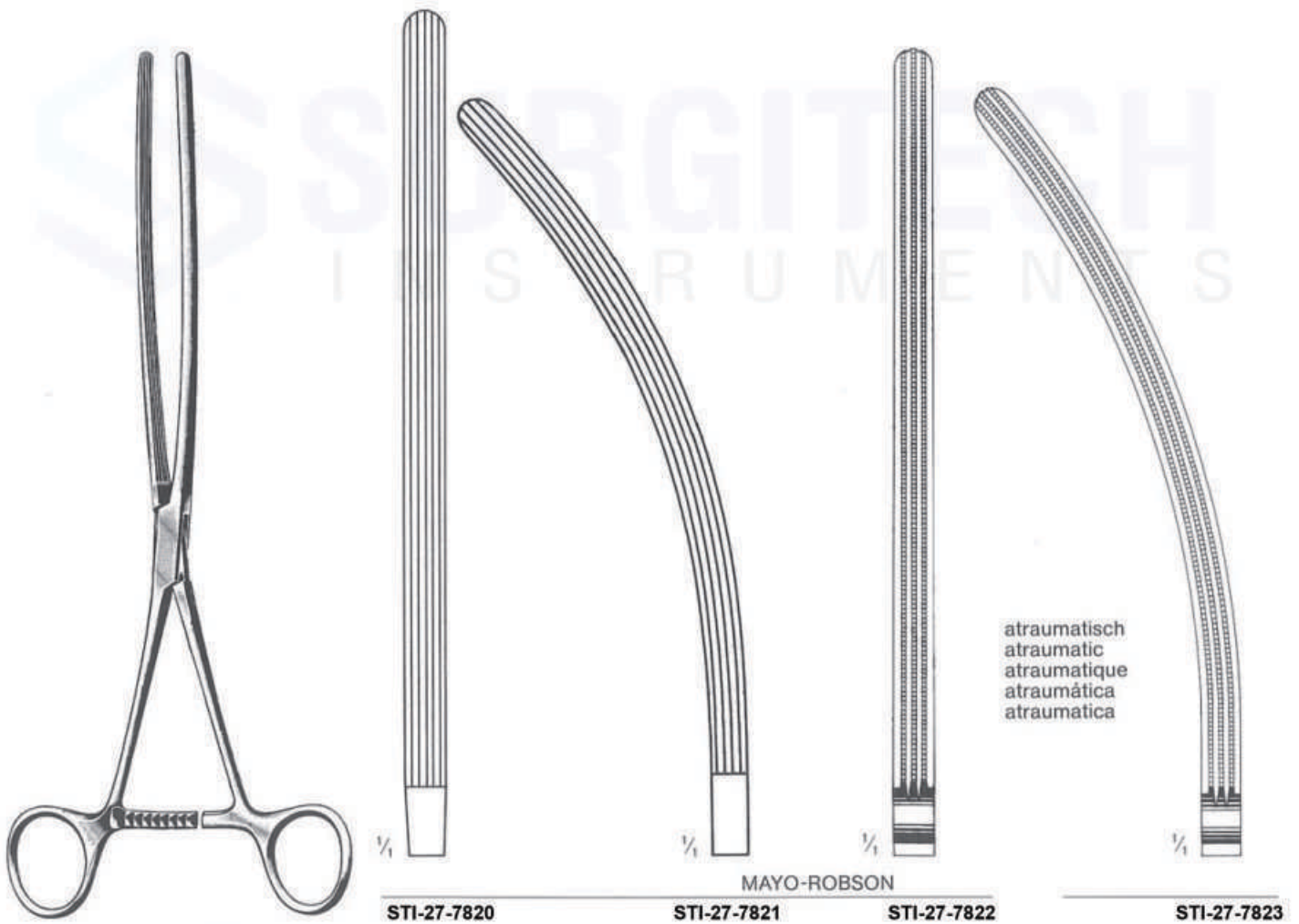

MAYO-ROBSON
STI-27-7820-7823
25 cm

STI-27-7820

STI-27-7821

STI-27-7822

STI-27-7823



normal FEHLAND atraum.
STI-27-7824 23,5 cm **STI-27-7825**

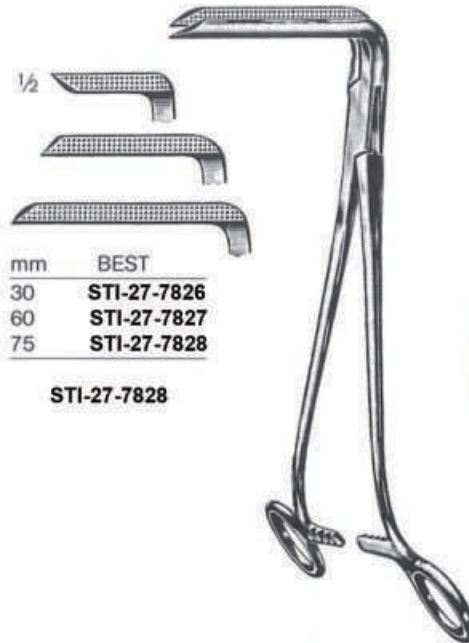

mm	BEST
30	STI-27-7826
60	STI-27-7827
75	STI-27-7828

STI-27-7828

Darm- und Magenklappen
 Intestinal and Stomach Clamps
 Pinzas-clamps intestinales
 Pinzas-clamps intestinales y estomacales
 Pinze intestinali e stomacali

BEST
STI-27-7826-7828
 26,5 cm



BRUNNER
STI-27-7829-7830
 24 cm

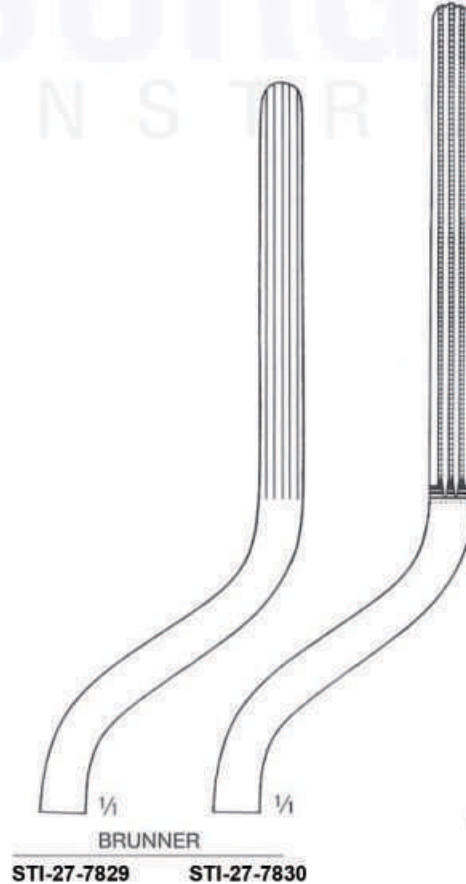

BRUNNER
STI-27-7829 **STI-27-7830**

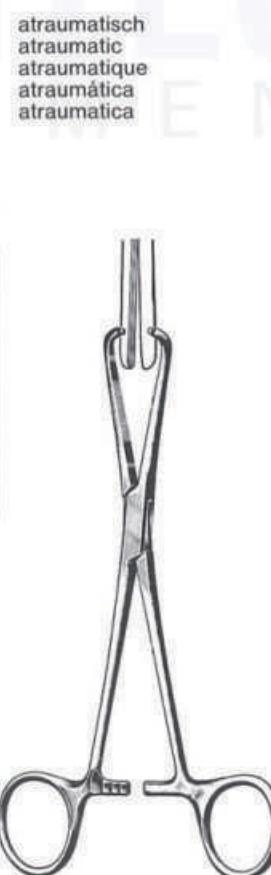

STONE
STI-27-7831
 15,5 cm

atraumatisch
 atraumatic
 atraumatique
 atraumática
 atraumatica

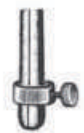

STONE-WATT
STI-27-7834



cm STONE-WATT
 7,5 **STI-27-7832**
 10 **STI-27-7833**

Anastomosenklemmen und Zubehör
Anastomosis Clamps and Accessories
Clamps à anastomose et accessoires
Clamps para anastomosis y accesorios
Pinze per anastomosi e accessori

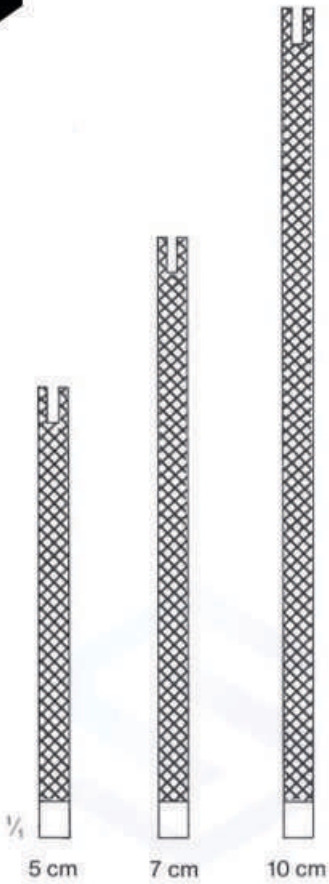

5 cm 7 cm 10 cm



cm	DE MARTEL-WOLFSON
5	STI-27-7834
7	STI-27-7835
10	STI-27-7836
Set/3	



DE MARTEL-WOLFSON
STI-27-7837
26 cm

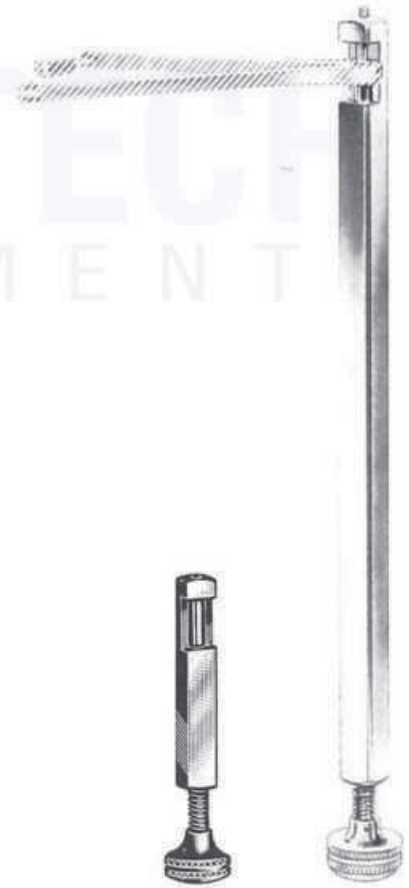

DE MARTEL-WOLFSON	
STI-27-7838	STI-27-7839
8,5 cm	23 cm

Magenklemmen
Stomach Clamps
Pincés-clamps stomacales
Pinzas-clamps estomacales
Pinze stomacali

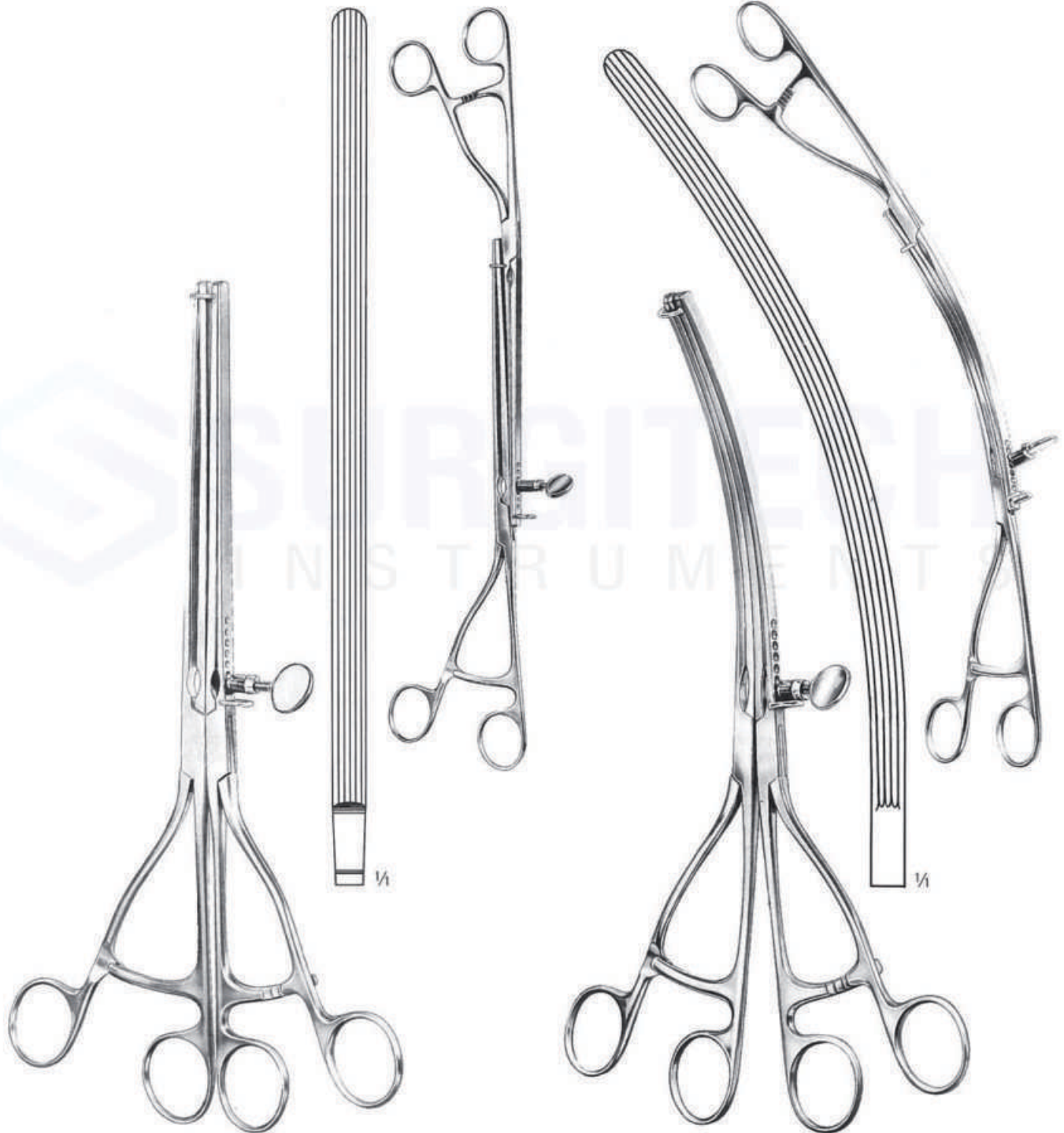

LANE
STI-27-7840
30 cm

LANE
STI-27-7841
30 cm

Magenklemmen
Stomach Clamps
Pincas-clamps stomacales
Pinzas-clamps estomacales
Pinze stomacali

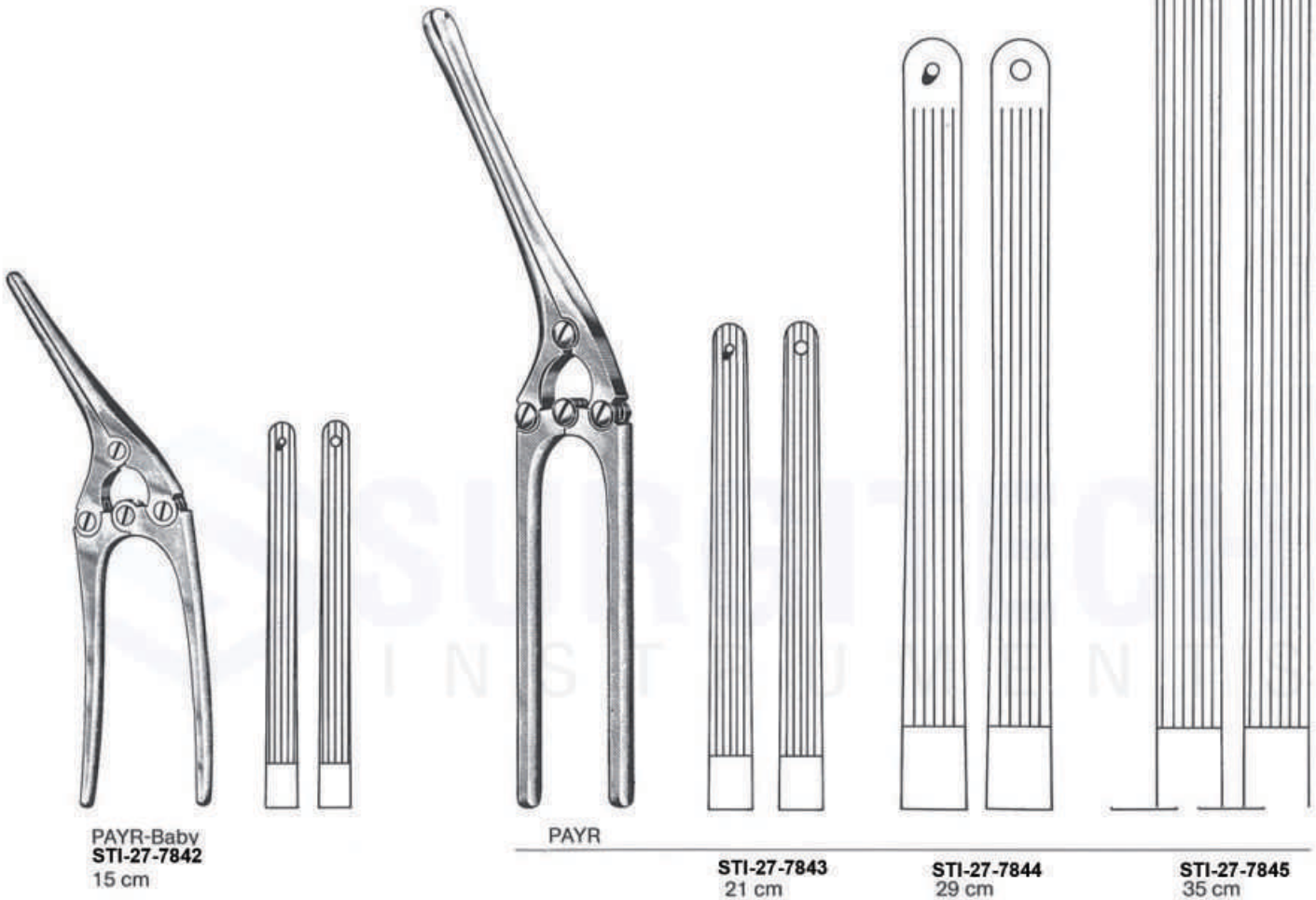

PAYR-Baby
STI-27-7842
15 cm

PAYR

STI-27-7843
21 cm

STI-27-7844
29 cm

STI-27-7845
35 cm

Magen- und Darmnähapparat · Stomach and Intestinal Suturing Apparatus · Appareil à sutures stomacales et intestinales · Aparato para suturas estomacales e intestinales · Apparecchio per suture stomacali e intestinali

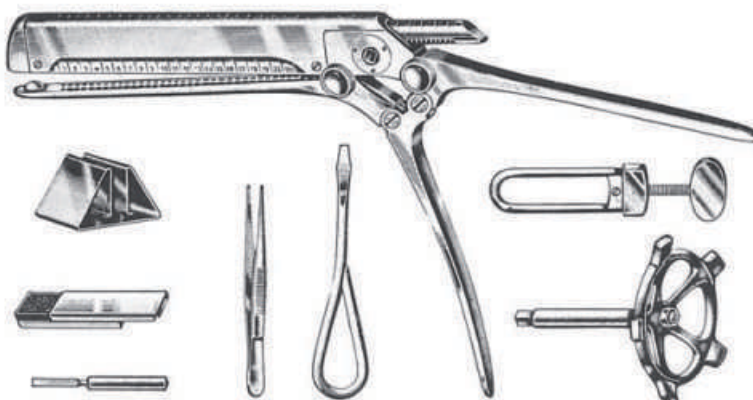

PETZ
STI-27-7846
compl.



300 Stück
300 ea.
300 pièces
300 c/u
300 pezzi

STI-27-7847



Urology

Prostata Haken, -Faßzange
Prostatic Retractors, Grasping Forceps
Ecarteurs à prostate, Pince à saisir la prostate
Separadores, Pinza para coger prostata
Divaricatori, Pinza per afferrare la prostata



YOUNG
STI-28-7848
21,5 cm

YOUNG
STI-28-7849
21,5 cm

YOUNG
STI-28-7850
20,5 cm

YOUNG
STI-28-7851
22 cm

YOUNG
STI-28-7852
20 cm



MILLIN
STI-28-7853
 24,5 cm



MILLIN
STI-28-7854
 24,5 cm



MILLIN
STI-28-7855
 22 cm



MILLIN
STI-28-7856
 22 cm



Fasszange für vordere Lappen
 Lobe Holding Forceps
 Pince pour saisir les lobes
 Pinza para lóbulos anteriores
 Pinza per lobuli anteriori



Fadenführungszange
 Ligature Carrying Forceps
 Pince porte-fil
 Pinza porta ligaduras
 Pinza porta-filo



MILLIN
STI-28-7857
 24,5 cm



35 mm

LEGUEU
STI-28-7858
27 cm



67 mm

KOCHER
STI-28-7859
26 cm



JUDD-MASSON
STI-28-7860



MILLIN

STI-28-7862

MILLIN**STI-28-7861**

komplett mit je 2 Seitenvalven
 57 x 25 mm und 80 x 25 mm,
 sowie 1 Mittelvalve 120 x 45 mm
ohne Kaltlichtaufsatz

complete with 2 pairs of lateral
 blades 57 x 25 mm and 80 x 25 mm
 and 1 central blade 120 x 45 mm
without F.O. Carrier

complet, avec 2 paires de valves laterales,
 57 x 25 mm et 80 x 25 mm,
 ainsi qu'une valve centrale 120 x 45 mm
sans support lumière froide

completo, con 2 pares de valvas laterales
 57 x 25 mm y 80 x 25 mm
 y una valva central 120 x 45 mm
sin portador de luz fria

completo, con 2 paia di valve laterali
 57 x 25 mm e 80 x 25 mm
 in piú 1 valva centrale 120 x 45 mm
senza supporto per luce fredda

MILLIN**STI-28-7862**

komplett mit je 2 Seitenvalven
 57 x 25 mm und 80 x 25 mm,
 sowie 1 Mittelvalve 120 x 45 mm
mit Kaltlichtaufsatz

complete with 2 pairs of lateral
 blades 57 x 25 mm and 80 x 25 mm
 and 1 central blade 120 x 45 mm
with F.O. Carrier

complet, avec 2 paires de valves laterales,
 57 x 25 mm et 80 x 25 mm,
 ainsi qu'une valve centrale 120 x 45 mm
avec support lumière froide

completo, con 2 pares de valvas laterales
 57 x 25 mm y 80 x 25 mm
 y una valva central 120 x 45 mm
con portador de luz fria

completo, con 2 paia di valve laterali
 57 x 25 mm e 80 x 25 mm
 in piú 1 valva centrale 120 x 45 mm
con supporto per luce fredda

MILLIN**STI-28-7863**

Kaltlichtaufsatz
 F.O. Light Carrier
 Supporto lumière froide
 Portador de luz fria
 Supporto per luce fredda



THOMSON-WALKER
STI-28-7864

komplett mit
2 Paar Seitenvalven,
1 Mittelvalve und
1 Retraktor

complete with
2 pairs of lateral blades
1 central blade and
1 retractor

complet avec
2 paires de valves laterales
1 valve centrale
1 écarteur

completo con
2 pares de valvas laterales
1 valva central
1 separador

completo con
2 paia di valve laterali
1 valva centrale e
1 retrattore



LEGUEU
STI-28-7865



MILLIN
STI-28-7866
29 cm



Fremdkörperzangen
Foreign Body Forceps
Pinceps à corps étrangers
Pinzas para cuerpos extranjeros
Pinze per corpi estranei



MATHIEU
STI-28-7867
Schaftlänge 20 cm
length of shaft 20 cm
longueur du tige 20 cm
longitud del vástago 20 cm
lunghezza del gambo 20 cm

MATHIEU
STI-28-7868
Schaftlänge 28 cm
length of shaft 28 cm
longueur du tige 28 cm
longitud del vástago 28 cm
lunghezza del gambo 28 cm

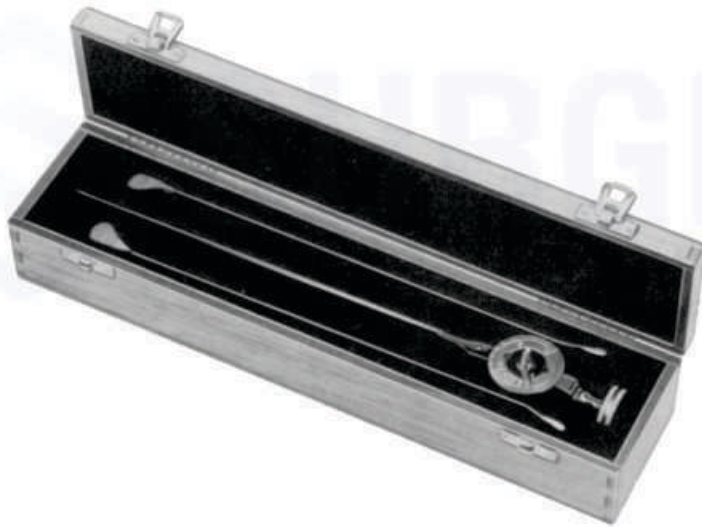

OTIS
STI-28-7869

komplett mit Holzetui
mit Dilator, 2 Messern und 3 Ansätzen

complete in wooden case
with dilator, 2 knives and 3 tips

complet, en boîte métal
avec dilatateur, 2 lames et 3 embouts

completo an caja de madera
con dilatador, 2 cuchillos y 3 puntas

completo, in contenitore di legno
con dilatatore, 2 bisturi e 3 punte



OTIS
STI-28-7870

Ersatmesser
Spare Blade
Couteau de rechange
Cuchillo de repuesto
Lama die ricambio

Circumcisionsgerät
 Circumcision Instrument
 Instrument de circoncision
 Instrumento para circuncisión
 Strumento per circuncisione



STI-28-7871 Ø 8 mm
STI-28-7872 Ø 11 mm
STI-28-7873 Ø 13 mm
STI-28-7874 Ø 16 mm
STI-28-7875 Ø 21 mm
STI-28-7876 Ø 26 mm
STI-28-7877 Ø 32 mm

Urethrographieinstrument
 Urethrography Instrument
 Instrument pour uréthrographie
 Instrumento para uretrografia
 Strumento per uretrografia



STI-28-7878

KNUTSON-KOCH
STI-28-7879

Konus
 Cone
 Cône
 Cono
 Cono

KNUTSON

STI-28-7878

Beschneidungsinstrument
 Circumcision Instrument
 Instrument de circoncision
 Instrumento para circuncisión
 Strumento per circuncisione



MOGAN
STI-28-7880
 für Erwachsene
 for adults
 pour adultes
 para adultos
 per adulti

MOGAN
STI-28-7882
 für Kinder
 for children
 pour enfants
 para niños
 per bambini

**WINKELMANN**

STI-28-7883 Ø 12 mm
STI-28-7884 Ø 16 mm
STI-28-7885 Ø 20 mm

Penisklemmen
Meatus Clamps
Compresseurs de l'urètre
Compressores uretrales
Serrapene



STOCKMANN
STI-28-7886
8 cm



STRAUSS
STI-28-7887
11 cm

Zange zum Erfassen der Glans und der Vorhaut
Forceps for grasping the glans and the foreskin



STI-28-7888
12,5 cm



STI-28-7889
14,5 cm

Klemme zum Fixieren des Samenstranges
Fixation clamp for the spermatic cord
Pince pour fixer le cordon
Pinza para fijar el cordón espermático
Pinza per fissare il tronco spermatico



GUTTMANN
STI-28-7890
 26,5 cm



DITTEL
STI-28-7891
 46 cm



GUYON
STI-28-7892
 46 cm



GUYON
STI-28-7893
 39 cm



GUYON
STI-28-7894
 35 cm

Gleitsonde, Harnröhrenbougies
Filiform Bougie, Urethral Sounds
Bougie conductrice, Bougies urétrales
Sonda filiforme, Bujias uretrales
Candeletta filiforme, Candelette dilatatrici

mit Schraubgewinde-Ansatz
with screw thread
avec ambout fileté
con rosca de tornillo
con attacco filettato



FILIFORM

STI-28-7895	3 Ch.
STI-28-7896	4 Ch.
STI-28-7897	5 Ch.
STI-28-7898	6 Ch.

Satz mit 21 Bougies, Charr. 10 bis 30
mit 4 Gleitsonden
im Metalletui 42 x 17,5 x 4 cm

set with 21 bougies, Charr. 10 to 30
with 4 filiform bougies
in metal case 42 x 17,5 x 4 cm

jeu avec 21 bougies, Charr. 10 jusqu' à 30
avec 4 bougies conductrices
en boîte métal 42 x 17,5 x 4 cm

juego de 21 bujias, Charr. 10 a 30
con 4 bujias filiformes
en caja metálica 42 x 17,5 x 4 cm

set di 21 dilatatori, Charr. 10 fino a 30
con 4 candelette dilatatrici
in contenitore metallico 42 x 17,5 x 4 cm



GUYON
STI-28-7899
compl.



VAN BUREN
STI-28-7901
 Set compl.
 8-36 Charr.

van BUREN	mm Ø	Charrière (French)
STI-28-7902	2	6
STI-28-7903	2 ² / ₃	8
STI-28-7904	3 ¹ / ₃	10
STI-28-7905	4	12
STI-28-7906	4 ² / ₃	14
STI-28-7907	5 ¹ / ₃	16
STI-28-7908	6	18
STI-28-7909	6 ² / ₃	20
STI-28-7910	7 ¹ / ₃	22
STI-28-7911	8	24
STI-28-7912	8 ² / ₃	26
STI-28-7913	9 ¹ / ₃	28
STI-28-7914	10	30
STI-28-7915	10 ² / ₃	32
STI-28-7916	11 ¹ / ₃	34
STI-28-7917	12	36
STI-28-7918	12 ² / ₃	38

mit Schraubgewinde-Ansatz
 with screw thread
 avec about fileté
 con rosca de tornillo
 con attacco filettato



GUYON
STI-28-7919
 Set compl.
 10-30 Charr.

GUYON	mm Ø	Charrière (French)
STI-28-7920	3 ¹ / ₃	10
STI-28-7921	3 ² / ₃	11
STI-28-7922	4	12
STI-28-7923	4 ¹ / ₃	13
STI-28-7924	4 ² / ₃	14
STI-28-7925	5	15
STI-28-7926	5 ¹ / ₃	16
STI-28-7927	5 ² / ₃	17
STI-28-7928	6	18
STI-28-7929	6 ¹ / ₃	19
STI-28-7930	6 ² / ₃	20
STI-28-7931	7	21
STI-28-7932	7 ¹ / ₃	22
STI-28-7933	7 ² / ₃	23
STI-28-7934	8	24
STI-28-7935	8 ¹ / ₃	25
STI-28-7936	8 ² / ₃	26
STI-28-7937	9	27
STI-28-7938	9 ¹ / ₃	28
STI-28-7939	9 ² / ₃	29
STI-28-7940	10	30



GUYON

GUYON	mm Ø	Charrière (French)
STI-28-7941	2 ² / ₃	8
STI-28-7942	3	9
STI-28-7943	3 ¹ / ₃	10
STI-28-7944	3 ² / ₃	11
STI-28-7945	4	12
STI-28-7946	4 ¹ / ₃	13
STI-28-7947	4 ² / ₃	14
STI-28-7948	5	15
STI-28-7949	5 ¹ / ₃	16
STI-28-7950	5 ² / ₃	17
STI-28-7951	6	18
STI-28-7952	6 ¹ / ₃	19
STI-28-7953	6 ² / ₃	20
STI-28-7954	7	21
STI-28-7955	7 ¹ / ₃	22
STI-28-7956	7 ² / ₃	23
STI-28-7957	8	24
STI-28-7958	8 ¹ / ₃	25
STI-28-7959	8 ² / ₃	26
STI-28-7960	9	27
STI-28-7961	9 ¹ / ₃	28
STI-28-7962	9 ² / ₃	29
STI-28-7963	10	30
STI-28-7964	10 ¹ / ₃	31
STI-28-7965	10 ² / ₃	32
STI-28-7966	11	33
STI-28-7967	11 ¹ / ₃	34
STI-28-7968	11 ² / ₃	35
STI-28-7969	12	36
STI-28-7970	12 ¹ / ₃	37
STI-28-7971	12 ² / ₃	38
STI-28-7972	13	39
STI-28-7973	13 ¹ / ₃	40
STI-28-7974	16 ² / ₃	50



für Männer
 for men
 pour hommes
 para hombres
 per uomini

	mm Ø	Charrière (French)
STI-28-7975	2 ² / ₃	8
STI-28-7976	3 ¹ / ₃	10
STI-28-7977	4	12
STI-28-7978	4 ² / ₃	14
STI-28-7979	5 ¹ / ₃	16
STI-28-7980	6	18
STI-28-7981	6 ² / ₃	20
STI-28-7982	7 ¹ / ₃	22
STI-28-7983	8	24



für Frauen
 for women
 pour femmes
 para mujeres
 per donne

	mm Ø	Charrière (French)
STI-28-7984	2 ² / ₃	8
STI-28-7985	3 ¹ / ₃	10
STI-28-7986	4	12
STI-28-7987	4 ² / ₃	14
STI-28-7988	5 ¹ / ₃	16
STI-28-7989	6	18
STI-28-7990	6 ² / ₃	20
STI-28-7991	7 ¹ / ₃	22
STI-28-7992	8	24



COXETER	mm Ø	Charrière (French)
STI-28-7993	2 ² / ₃	8
STI-28-7994	3 ¹ / ₃	10
STI-28-7995	4	12
STI-28-7996	4 ² / ₃	14
STI-28-7997	5 ¹ / ₃	16
STI-28-7998	6	18
STI-28-7999	6 ² / ₃	20
STI-28-8001	7 ¹ / ₃	22
STI-28-8002	8	24



WALTHER	mm Ø	Charrière (French)
STI-28-8003	4	12
STI-28-8004	4 ² / ₃	14
STI-28-8005	5 ¹ / ₃	16
STI-28-8006	6	18
STI-28-8007	6 ² / ₃	20
STI-28-8008	7 ¹ / ₃	22
STI-28-8009	8	24
STI-28-8010	8 ² / ₃	26
STI-28-8011	9 ¹ / ₃	28
STI-28-8012	10	30
STI-28-8013	10 ² / ₃	32
STI-28-8014	10 ¹ / ₃	34
STI-28-8015	12	36
STI-28-8016	12 ² / ₃	38

WALTHER
 STI-28-8017
 34,5 cm

Satz komplett
 complete set
 jeu complet
 juego completo
 set completo
 66.212.12 - 66.212.38



DITTEL	mm Ø	Charrière (French)
STI-28-8019	2 ² / ₃	8
STI-28-8020	3	9
STI-28-8021	3 ¹ / ₃	10
STI-28-8022	3 ² / ₃	11
STI-28-8023	4	12
STI-28-8024	4 ¹ / ₃	13
STI-28-8025	4 ² / ₃	14
STI-28-8026	5	15
STI-28-8027	5 ¹ / ₃	16
STI-28-8028	5 ² / ₃	17
STI-28-8029	6	18
STI-28-8030	6 ¹ / ₃	19
STI-28-8031	6 ² / ₃	20
STI-28-8032	7	21
STI-28-8033	7 ¹ / ₃	22
STI-28-8034	7 ² / ₃	23
STI-28-8035	8	24
STI-28-8036	8 ¹ / ₃	25
STI-28-8037	8 ² / ₃	26
STI-28-8038	9	27
STI-28-8039	9 ¹ / ₃	28
STI-28-8040	9 ² / ₃	29
STI-28-8041	10	30
STI-28-8042	10 ² / ₃	32

DITTEL
STI-28-8018

Satz komplett (23)
 complet set (23)
 jeu complet (23)
 juego completo (23)
 set completo (23)
 66.225.08 - 66.225.30

DITTEL
STI-28-8043

Satz komplett (6)
 complet set (6)
 jeu complet (6)
 juego completo (6)
 set completo (6)
 66.225.08/12/16/20/24/30

 DITTEL
 34,5 cm

DITTEL	mm Ø	Charrière (French)
STI-28-8044	2 ² / ₃	8
STI-28-8045	3	9
STI-28-8046	3 ¹ / ₃	10
STI-28-8047	3 ² / ₃	11
STI-28-8048	4	12
STI-28-8049	4 ¹ / ₃	13
STI-28-8050	4 ² / ₃	14
STI-28-8051	5	15
STI-28-8052	5 ¹ / ₃	16
STI-28-8053	5 ² / ₃	17
STI-28-8054	6	18
STI-28-8055	6 ¹ / ₃	19
STI-28-8056	6 ² / ₃	20
STI-28-8057	7	21
STI-28-8058	7 ¹ / ₃	22
STI-28-8059	7 ² / ₃	23
STI-28-8060	8	24
STI-28-8061	8 ¹ / ₃	25
STI-28-8062	8 ² / ₃	26
STI-28-8063	9	27
STI-28-8064	9 ¹ / ₃	28
STI-28-8065	9 ² / ₃	29
STI-28-8066	10	30



Rectum

Mastdarm-Spekula
Rectal Specula
Spéculum rectaux
Espéculos rectales
Specoli rettali



CZERNY
STI-29-8067
22 cm



SIMS
STI-29-8068
15 cm



BODENHAMMER
STI-29-8069

STI-29-8070 = Kaltlicht · Cold Light
Lumière froide
Luz fría · Luce fredda

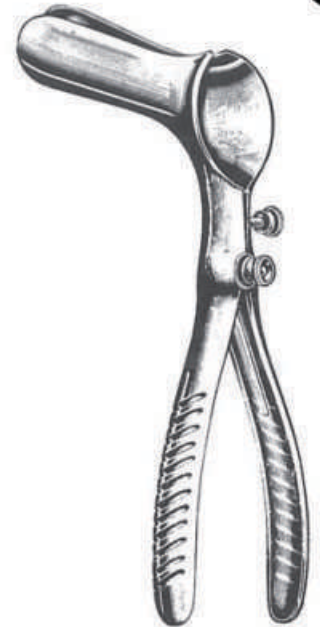

PRATT
STI-29-8071



BARR
STI-29-8072
70 x 22 mm
17 cm



MATHIEU
STI-29-8073
19,5 cm

Mastdarm-Spreizer
 Anal Retractors
 Dilatateurs p. anus et rectum
 Separadores rectales
 Dilattori per l'ano e il retto

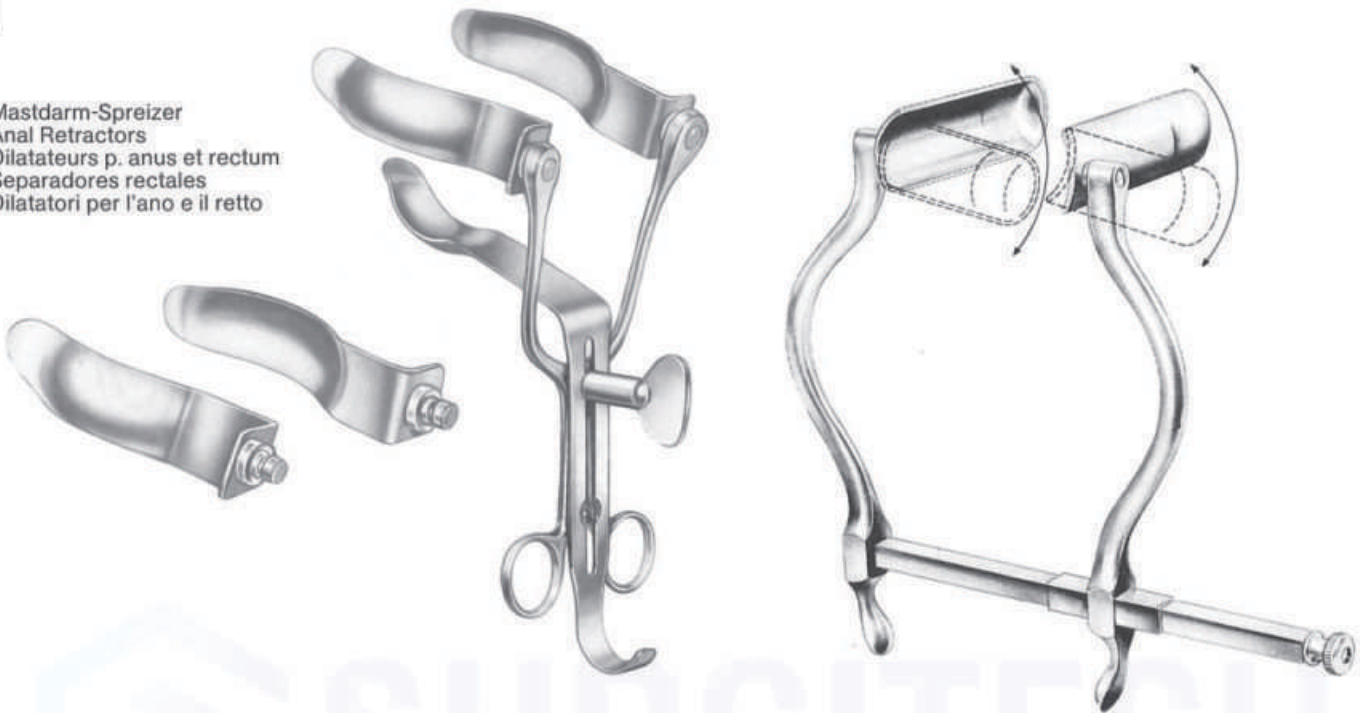

ALAN-PARKS
STI-29-8074
 compl.
 13,5 cm

SMITH-BUIE
STI-29-8076
 75 x 23 mm
 15 cm

STI-29-8075
 Kaltlicht-Adapter für **STI-29-8074**
 Cold Light Attachment for **STI-29-8074**
 Adaptateur lumière froide pour **STI-29-8074**
 Adaptador luz fría para **STI-29-8074**
 Adattatore luce fredda per **STI-29-8074**

Rektoskop
 Rectoscope
 Rectoscope
 Rettoscopio
 Rettoscopio

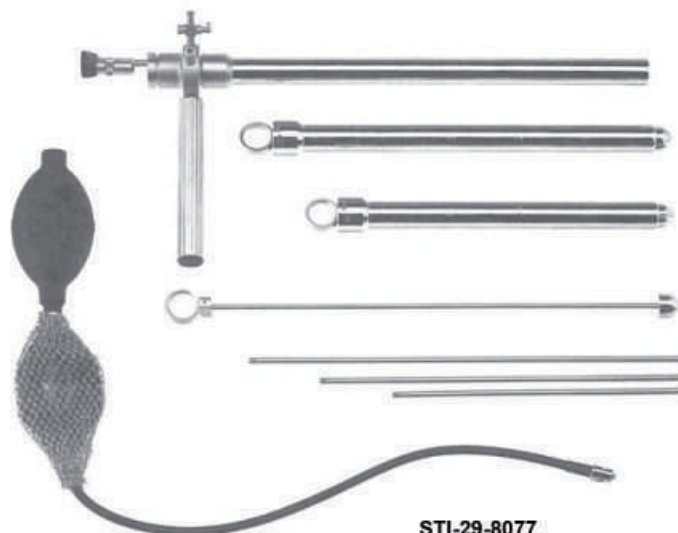

STI-29-8077
 compl.

Kaltlicht · Cold Light · Lumière froide
 Luz fría · Luce fredda

Anoskope, Proktoskope
Anoscopes, Proctoscopes
Anuscopes, Proctoscopes
Anoscopios, Proctoscopios
Anoscopi, Protoscopi



IVES-FANSLER
STI-29-8078
22 mm Ø
L = 80 mm



Ø mm HIRSCHMANN
16 **STI-29-8079**
19 **STI-29-8080**
22 **STI-29-8081**
L = 65 mm



mm
Ø x L **KELLY**
22 x 50 **STI-29-8084**
22 x 100 **STI-29-8085**
22 x 140 **STI-29-8086**
22 x 200 **STI-29-8087**

Cystikus-Haken
Cystic Hooks
Ecarteurs rectaux
Ganchos rectales
Uncini rettali



Ø mm **KELLY**
21 **STI-29-8082**
27 **STI-29-8083**
L = 50 mm



STI-29-8087
Fig. 1

STI-29-8088
Fig. 2

STI-29-8089
Fig. 3

PRATT
STI-29-8087-8089



Biopsie-Zangen
Biopsy Specimen Forceps
Pincas emporte-pièce à biopsie
Pinzas sacabocado para biopsia
Pinze per biopsia

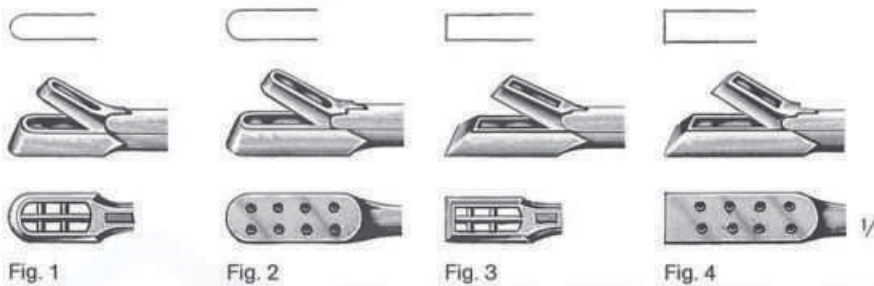
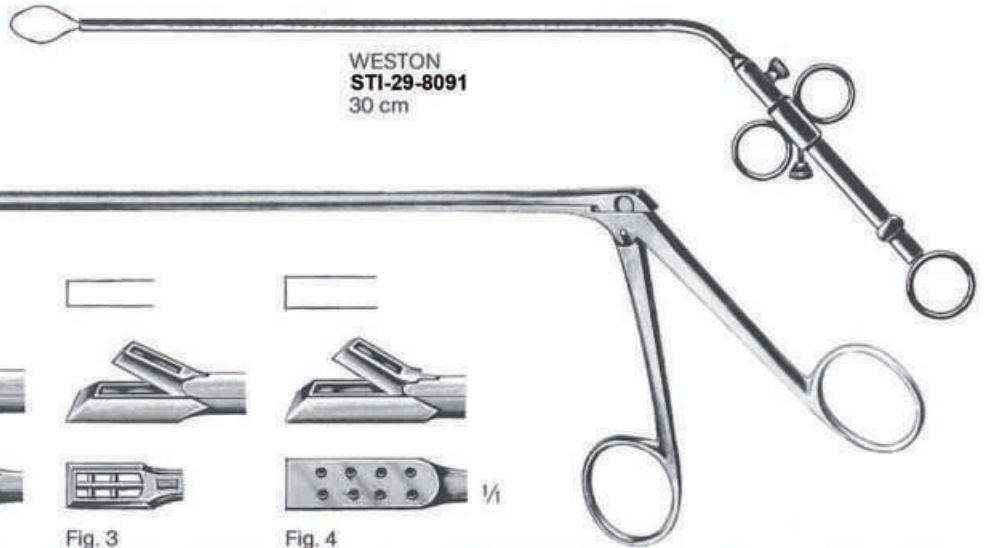

				cm	YEOMAN
STI-29-8092	STI-29-8093	STI-29-8094	STI-29-8095	28	
STI-29-8096	STI-29-8097	STI-29-8098	STI-29-8099	35	
STI-29-8101	STI-29-8102	STI-29-8102	STI-29-8103	42	



cm	YEOMAN
23	STI-29-8104
33	STI-29-8105
40	STI-29-8106



cm	TURREL
23	STI-29-8107
33	STI-29-8108
40	STI-29-8109

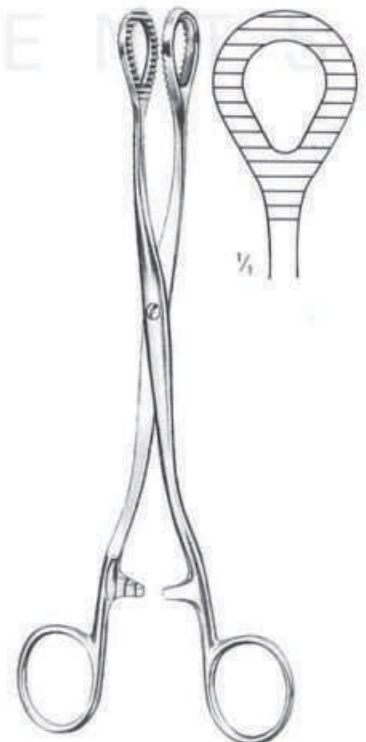

Gynecology





GRAVE

Fig.	mm	Standard	Laser Mod.
1	75x20	STI-30-8111	STI-30-8114
2	95x35	STI-30-8112	STI-30-8115
3	115x35	STI-30-8113	STI-30-8116



GRAVE

Fig.	mm	Standard
2	95x35	STI-30-8117

mit Absaugung
 with suction
 avec aspiration
 con aspiradoras
 con aspirazione



extra klein
 extra small
 extra petit
 extra pequeno
 extra piccolo

GRAVE
STI-30-8118
 76 x 12 mm



extra groß
 extra large
 extra grande
 extra grande
 extra grande

GRAVE
STI-30-8119
 120 x 38 mm

PEDERSON

Fig.	mm	
1	75x13	STI-30-8120
2	100x22	STI-30-8121
3	120x25	STI-30-8122

PEDERSON
STI-30-8123
 100 x 31 mm

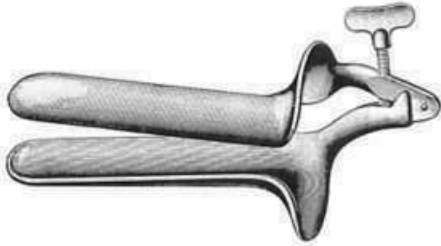

COLLIN

Fig.	mm	
1	85x30	STI-30-8124
2	100x35	STI-30-8125
3	110x40	STI-30-8126



COLLIN
STI-30-8127
 65x20 mm



COLLIN
STI-30-8128
 65x10 mm



Seitl. Schraube
 Lateral Screw
 Vis latérale
 Tornillo lateral
 Vite laterale

CUSCO

Fig.	mm	Standard	Laser Mod.
0	80x24	STI-30-8129	
1	75x32	STI-30-8130	
2	85x35	STI-30-8131	STI-30-8133
3	100x35	STI-30-8132	STI-30-8134



CUSCO
 STI-30-8135
 75x17 mm



Mittelschraube
 Central Screw
 Vis centrale
 Tornillo central
 Vite centrale

CUSCO	mm
STI-30-8136	80x24
STI-30-8137	75x32
STI-30-8138	85x36
STI-30-8139	95x37
STI-30-8140	110x37
STI-30-8141	75x17

flache Entenschnabelform
 flat duck beak
 plat bec de canard
 pico de pato llano
 becco d'anatra piatto



CUSCO	mm
STI-30-8142	80x32
STI-30-8143	90x37
STI-30-8144	115x37

Schweizer Modell
 Swiss Pattern
 Modèle suisse
 Modelo suizo
 Modello svizzero



Fig.	mm	CUSCO
1	90x23-25	STI-30-8145
2	100x25-27	STI-30-8146
3	110x27-30	STI-30-8147



FREEWAY GRAVE
STI-30-8148
 100 x 32 mm



FREEWAY GRAVE
STI-30-8149
 45°



mm	TRELAT
85x33	STI-30-8150
95x35	STI-30-8151
115x43	STI-30-8152



mm	SEMM
90x14-18	STI-30-8153
100x17-20	STI-30-8154
100x25-30	STI-30-8155



O'SULLIVAN O'CONNOR
STI-30-8156

komplett
complete
complet
completo
completo



STI-30-8157
Fig. 1
45x17 mm

STI-30-8158
Fig. 2
90x37 mm

STI-30-8159
Fig. 3
90x45mm



Satz Fig.
set no.
jeu no.
juego no.
serie no.

bestehend aus
consisting of
se composant de
consiste de
composto da

KRISTELLER

STI-30-8160	0	STI-30-8164	STI-30-8168
STI-30-8161	1	STI-30-8165	STI-30-8169
STI-30-8162	2	STI-30-8166	STI-30-8170
STI-30-8163	3	STI-30-8167	STI-30-8171



Fig.	mm	KRISTELLER
0	70x15	STI-30-8164
1	70x27	STI-30-8165
2	80x30	STI-30-8166
3	90x36	STI-30-8167

Spekulum
Speculum
Spéculum
Espéculo
Specolo

Fig.	mm	KRISTELLER
0	75x10	STI-30-8168
1	75x23	STI-30-8169
2	85x26	STI-30-8170
3	100x32	STI-30-8171

Halter
Retractor
Valve
Valva



Mit konischen Blättern, für Jungfrauen
 With taper blades, for virgins
 A valves coniques, pour vierges
 Con hojas cónicas, para vírgenes
 Con valve coniche, per vergini

Satz Fig.
 set no.
 jeu no.
 juego no.
 serie no.

bestehend aus
 consisting of
 se composant de
 consiste de
 composto da

KRISTELLER

STI-30-8172	1	STI-30-8174+ STI-30-8176
STI-30-8173	2	STI-30-8175+ STI-30-8177



mm	KRISTELLER
105x18	STI-30-8174
105x21	STI-30-8175

Spekulum
 Speculum
 Spéculum
 Espéculo
 Specolo

mm	KRISTELLER
110x14	STI-30-8176
115x17	STI-30-8177

Halter
 Retractor
 Valve
 Valva

 Satz Fig.
 set no.
 jeu no.
 juego no.
 serie no.

 bestehend aus
 consisting of
 se comstant de
 consiste de
 composto da
KRISTELLER

STI-30-8178	1	STI-30-8181+ STI-30-8184
STI-30-8179	2	STI-30-8182+ STI-30-8185
STI-30-8180	3	STI-30-8183+ STI-30-8186

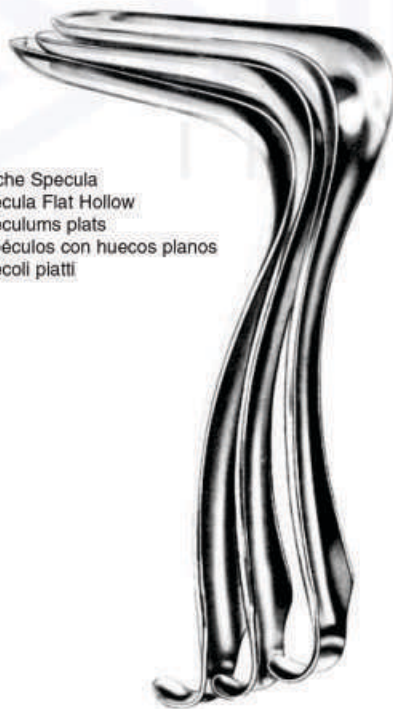
 Flache Specula
 Specula Flat Hollow
 Spéculums plats
 Espécules con huecos planos
 Specoli piatti

KRISTELLER	Fig.	mm
STI-30-8181	1	105 x 26
STI-30-8182	2	105 x 25
STI-30-8183	3	105 x 33

 Spekulum
 Speculum
 Spéculum
 Espéculo
 Specolo

KRISTELLER	Fig.	mm
STI-30-8184	1	115 x 22
STI-30-8185	2	115 x 24
STI-30-8186	3	115 x 29

 Halter
 Retractor
 Valve
 Valva



Satz Fig.
 set no.
 jeu no.
 juego no.
 serie no.

bestehend aus
 consisting of
 se compondant de
 consiste de
 composto da

KRISTELLER

STI-30-8187	00	STI-30-8192 + STI-30-8197
STI-30-8188	0	STI-30-8193 + STI-30-8198
STI-30-8189	1	STI-30-8194 + STI-30-8199
STI-30-8190	2	STI-30-8195 + STI-30-8201
STI-30-8191	3	STI-30-8196 + STI-30-8202



Fig.	mm	KRISTELLER
00	110x18	STI-30-8192
0	110x20	STI-30-8193
1	110x27	STI-30-8194
2	110x30	STI-30-8195
3	110x36	STI-30-8196

Spekulum
 Speculum
 Spéculum
 Espéculo
 Specolo

Fig.	mm	KRISTELLER
00	115x14	STI-30-8197
0	115x17	STI-30-8198
1	115x23	STI-30-8199
2	115x26	STI-30-8201
3	115x32	STI-30-8202

Halter
 Retractor
 Valve
 Valva



Für Kinder
 For children
 Pour enfants
 Para niños
 Per bambini

Satz Fig.
 set no.
 jeu no.
 juego no.
 serie no.

bestehend aus
 consisting of
 se composant de
 consiste de
 composto da

KRISTELLER
STI-30-8203

0

STI-30-8204+STI-30-8205



KRISTELLER
 mm
 70x15 **STI-30-8204**

Spekulum
 Speculum
 Spéculum
 Espéculo
 Specolo



KRISTELLER
 mm
 75x10 **STI-30-8205**

Halter
 Retractor
 Valve
 Valva

Vaginalspekula, Scheidenhalter
 Vaginal Specula, Vaginal Retractors
 Speculums vaginaux, Velves vaginales
 Espéculos vaginales, Valvas vaginales
 Specoli vaginali, Valve vaginali



Satz Fig.
 set no.
 jeu no.
 juego no.
 serie no.

bestehend aus
 consisting of
 se composant de
 consiste de
 composto da

KRISTELLER
STI-30-8206

0

STI-30-8207 + STIV-30-8208



mm **KRISTELLER**
 135x36 **STI-30-8207**

Spekulum
 Speculum
 Spéculum
 Espéculo
 Specolo

mm **KRISTELLER**
 140x30 **STI-30-8208**

Halter
 Retractor
 Valve
 Valva



Satz Fig.
set no.
jeu no.
juego no.
serie no.

bestehend aus
consisting of
se composant de
consiste de
composto da

KALLMORGEN

STI-30-8209	1	STI-30-8211	STI-30-8213
STI-30-8210	2	STI-30-8212	STI-30-8214



mm KALLMORGEN

70x40 **STI-30-8211**

90x40 **STI-30-8212**

Spekulum
Speculum
Spéculum
Espéculo
Specolo



mm KALLMORGEN

70x33 **STI-30-8213**

90x33 **STI-30-8214**

Halter
Retractor
Valve
Valva

56 x 13 mm



mm **BRAUN**
 56x13 **STI-30-8215**

60 x 10 mm



mm **BRAUN**
 60x10 **STI-30-8216**



flaches Spekulum
 flat speculum
 spéculum plat
 espéculo plano
 specolo piatto

JACKSON



STI-30-8217
 75 x 40 mm



STI-30-8218
 90 x 40 mm



STI-30-8219
 100 x 40 mm



Fig. 1 = klein/small/petit/pequeno/piccolo
 Fig. 2 = mittel/medlum/moyen/mediano/medio
 Fig. 3 = groß/large7grand/grande

SIMS	Fig.	mm	
	1	70x25	STI-30-8220
	2	85x30	STI-30-8221
	3	100x40	STI-30-8222

Scheidenspekula, doppelendig
 Vaginal specula, double-ended
 Spéculums vaginaux, doubles
 Espéculos vaginales, dobles
 Speculi vaginali, doppi

STI-30-8223= Set

bestehend aus
 consisting of
 consiste de
 se composant de
 composto da

70.291.01/70.291.02/70.291.03



Fig.	mm	SIMS
1	65x25, 70x30	STI-30-8224
2	70x30, 70x35	STI-30-8225
3	85x35, 90x40	STI-30-8226



leicht hohl
 slightly concave
 légèrement concave
 ligeramente cóncavo
 leggermente concavo

Fig.	mm	DOYEN
1	75x45	STI-30-8227
2	90x45	STI-30-8228
3	110x45	STI-30-8229

Fig.	mm	DOYEN
1	55x35	STI-30-8230
2	75x35	STI-30-8231
3	115x35	STI-30-8232
1	55x45	STI-30-8233
2	75x45	STI-30-8234
3	115x45	STI-30-8235
4	160x45	STI-30-8236
1	55x60	STI-30-8237
2	75x60	STI-30-8238
3	115x60	STI-30-8239
4	160x60	STI-30-8240



AUVARD
STI-30-8241
83x38 mm
Loses Gewicht
Detachable Weight
Poids démontable
Pessa desmontable
Peso smontabile

AUVARD
STI-30-8242
83 x 38 mm
Festes Gewicht
Fixed Weight
Poids fixe
Pessa fija
Peso fisso



mm	BREISKY
100x20	STI-30-8243
100x25	STI-30-8244
100x30	STI-30-8245
100x35	STI-30-8246
100x40	STI-30-8247
130x20	STI-30-8248
130x25	STI-30-8249
130x30	STI-30-8250
130x35	STI-30-8251
130x40	STI-30-8252
155x40	STI-30-8253



DOYEN
STI-30-8254
25,0 cm

SCHERBAK
70.318.00

Satz komplett mit Griff,
 Gewicht (400 g) und 5 Blättern
 complete Set with handle,
 weight (400 g) and 5 blades
 jeu complet avec manche,
 poids (400 g) et 5 valves
 juego completo con mango,
 peso (400 g) y 5 valvas
 Set completo con manico,
 peso (400 g) e 5 valve

Blatt allein
 Specula Blade only
 Valve vaginale, seule
 Valva vaginal, suelta
 Valve vaginale, sola

SCHERBAK

STI-30-8255	80x30 mm
STI-30-8256	85x35 mm
STI-30-8257	90x40 mm

SCHERBAK

STI-30-8258	62x40-60 mm
STI-30-8259	81x45-70 mm

Gewicht zum Vaginalspekulum
 Weight for Vaginal Speculum
 Poids pour spéculum vaginal
 Peso para especulo vaginal
 Peso per specolo vaginale



SCHERBAK
STI-30-8260
 10,5 cm
 400 g

SCHERBAK
STI-30-8261
 13,0 cm
 800 g

Griff zum Vaginalspekulum
 Handle for Vaginal Speculum
 Manche pour spéculum vaginal
 Mango para especulo vaginal
 Manico per specolo vaginale



SCHERBAK
STI-30-8262
 20,0 cm



LANDAU

STI-30-8263	100x28 mm
STI-30-8264	100x38 mm



STI-30-8266

Auffangsieb
Strainer for Vaginal Speculum
Tarnis pour spéculum vaginal
Tamiz para especulo vaginal
Crivello per specolo vaginale

WEISSBARTH

STI-30-8265

80x42 mm

komplett, mit abnehmbarem Auffangkorb
complete, with detachable strainer
complet avec tamiz demontable
completo, con tamiz desmontable
completo con crivello smontabile

**FRIEDMANN**

STI-30-8267	10,0 cm
STI-30-8268	15,0 cm

mit skaliertes Sperre und Fixierschraube
 with graduated ratchet and fixing screw
 avec crémaillère à échelle et vis à fixation
 con cremallera graduada y tornillo de fijación
 con cremagliera con scala e vite di fissaggio



KOGAN
STI-30-8269
 24,5 cm



Standard	KOGAN	Laser
STI-30-8270	24,0 cm	STI-30-8271

HEGAR
STI-30-8272

Satz mit 14 Stück (ganze Größen)
 von 4,0 - 17,0 mm ohne Etui

set of 14 pieces (full sizes)
 from 4,0 - 17,0 mm without case

jeu de 14 pièces (taille entière)
 de 4,0 - 17,0 mm sans boîte

juego de 14 piezas (tamaños enteros)
 de 4,0 - 17,0 mm sin caja

serie di 14 pezzi (grandezza intera)
 da 4,0 - 17,0 mm senza scatola



HEGAR
EV-30-8273

Satz mit 26 Stück (ganze Größen)
 von 1,0 - 26,0 mm ohne Etui

set of 26 pieces (full sizes)
 from 1,0 - 26,0 mm without case

jeu de 26 pièces (taille entière)
 de 1,0 - 26,0 mm sans boîte

juego de 26 piezas (tamaños enteros)
 de 1,0 - 26,0 mm sin caja

serie di 26 pezzi (grandezza intera)
 da 1,0 - 26,0 mm senza scatola

HEGAR	mm	HEGAR	mm
STI-30-8274	1	STI-30-8305	1,5
STI-30-8275	2	STI-30-8306	2,5
STI-30-8276	3	STI-30-8307	3,5
STI-30-8277	4	STI-30-8308	4,5
STI-30-8278	5	STI-30-8309	5,5
STI-30-8279	6	STI-30-8310	6,5
STI-30-8280	7	STI-30-8311	7,5
STI-30-8281	8	STI-30-8312	8,5
STI-30-8282	9	STI-30-8313	9,5
STI-30-8283	10	STI-30-8314	10,5
STI-30-8284	11	STI-30-8315	11,5
STI-30-8285	12	STI-30-8316	12,5
STI-30-8286	13	STI-30-8317	13,5
STI-30-8287	14	STI-30-8318	14,5
STI-30-8288	15	STI-30-8319	15,5
STI-30-8289	16	STI-30-8320	16,5
STI-30-8290	17	STI-30-8321	17,5
STI-30-8291	18	STI-30-8322	18,5
STI-30-8292	19	STI-30-8323	19,5
STI-30-8293	20		
STI-30-8294	21		
STI-30-8295	22		
STI-30-8296	23		
STI-30-8297	24		
STI-30-8298	25		
STI-30-8299	26		
STI-30-8301	27		
STI-30-8302	28		
STI-30-8303	29		
STI-30-8304	30		

Uterusdilatore
Uterine Dilators
Dilatateurs du col de l'utérus
Dilataores uterinos
Dilatatori uterini



HEGAR
STI-30-8324
4-17 mm
14 Stück/ea./pces./c./u./pezzi



in Metalletui
in metal case
en boîte metal
en caja metalica
in scatola metallica

HEGAR	mm	
STI-30-8325	4-17	14 Stück/ea./pces./c./u./pezzi
STI-30-8326	1-26	26 Stück/ea./pces./c./u./pezzi

HEGAR
EV-30-8340

Satz mit 8 Stück von 3,0 / 4,0 - 17,0 / 18,0 mm
ohne Etui

set of 8 pieces from 3,0 / 4,0 - 17,0 / 18,0 mm
without case

jeu de 8 pièces de 3,0 / 4,0 - 17,0 / 18,0 mm
sans boîte

juego de 8 piezas de 3,0 / 4,0 - 17,0 / 18,0 mm
sin caja

serie di 8 pezzi da 3,0 / 4,0 - 17,0 / 18,0 mm
senza scatola

HEGAR
EV-30-8341

Satz mit 13 Stück von 1,0 / 2,0 - 25,0 / 26,0 mm
ohne Etui

set of 13 pieces from 1,0 / 2,0 - 25,0 / 26,0 mm
without case

jeu de 13 pièces de 1,0 / 2,0 - 25,0 / 26,0 mm
sans boîte

juego de 13 piezas de 1,0 / 2,0 - 25,0 / 26,0 mm
sin caja

serie di 13 pezzi da 1,0 / 2,0 - 25,0 / 26,0 mm
senza scatola

HEGAR	mm
EV-30-8327	1/ 2
EV-30-8328	3/ 4
EV-30-8329	5/ 6
EV-30-8330	7/ 8
EV-30-8331	9/10
EV-30-8332	11/12
EV-30-8333	13/14
EV-30-8334	15/16
EV-30-8335	17/18
EV-30-8336	19/20
EV-30-8337	21/22
EV-30-8338	23/24
EV-30-8339	25/26

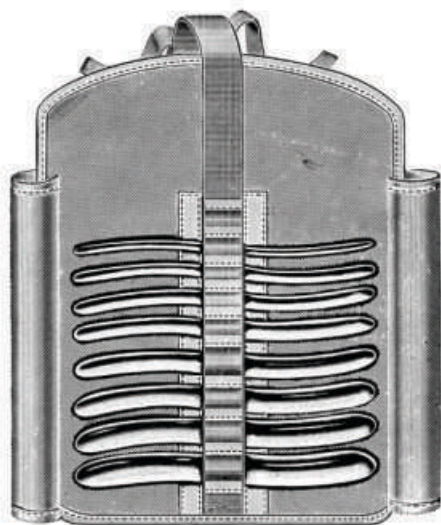

HEGAR
STI-30-8342

Satz mit 8 Stück von 3,0 / 4,0 - 17,0 / 18,0 mm
in auskochbarer Stoffrolltasche

set of 8 pieces from 3,0 / 4,0 - 17,0 / 18,0 mm
in boilable canvas roll

jeu de 8 pièces de 3,0 / 4,0 - 17,0 / 18,0 mm
en pochette en treillis stérilisable par ébullition

juego de 8 piezas de 3,0 / 4,0 - 17,0 / 18,0 mm
en bolsa de tela esterilizable por ebullicion

serie di 8 pezzi da 3,0 / 4,0 - 17,0 / 18,0 mm
in busta di tela sterilizzabile

HEGAR
STI-30-8343

Satz mit 8 Stück von 3,0 / 4,0 - 17,0 / 18,0 mm
im Metalletui mit Scharnierdeckel

set of 8 pieces from 3,0 / 4,0 - 17,0 / 18,0 mm
in metal case with hinged lid

jeu de 8 pièces de 3,0 / 4,0 - 17,0 / 18,0 mm
en boîte métal à charnière

juego de 8 piezas de 3,0 / 4,0 - 17,0 / 18,0 mm
en caja metálica con tapa de bisagra

serie di 8 pezzi da 3,0 / 4,0 - 17,0 / 18,0 mm
in scatola metallica con coperchio a cerniera



HEGAR
STI-30-8344

Satz mit 13 Stück von 1,0 / 2,0 - 25,0 / 26,0 mm
im Metalletui mit Scharnierdeckel

set of 13 pieces from 1,0 / 2,0 - 25,0 / 26,0 mm
in metal case with hinged lid

jeu de 13 pièces de 1,0 / 2,0 - 25,0 / 26,0 mm
en boîte métal à charnière

juego de 13 piezas de 1,0 / 2,0 - 25,0 / 26,0 mm
en caja metálica con tapa de bisagra

serie di 13 pezzi da 1,0 / 2,0 - 25,0 / 26,0 mm
in scatola metallica con coperchio a cerniera

 amerikanische Skala
 American scala
 échelle américaine
 escala americana
 scala americana

HANK
STI-30-8355

 Satz mit 6 Stück
 von 4,5 - 10,0 mm ohne Etui

 set of 6 pieces
 from 4,5 - 10,0 mm without case

 jeu de 6 pièces
 de 4,5 - 10,0 mm sans boîte

 juego de 6 piezas
 de 4,5 - 10,0 mm sin caja

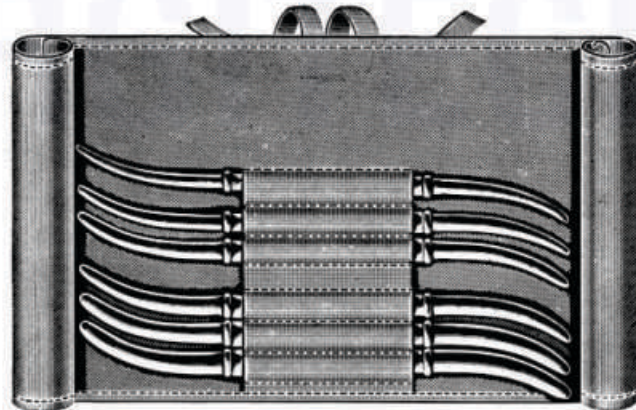
 serie di 6 pezzi
 da 4,5 - 10,0 mm senza scatola

HANK
STI-30-8356

 Satz mit 6 Stück von 4,5 - 10,0 mm
 in auskochbarer Stoffrolltasche

 set of 6 pieces from 4,5 - 10,0 mm
 in boilable canvas roll

 jeu de 6 pièces de 4,5 - 10,0 mm
 en pochette en treillis stérilisable par ébullition

 juego de 6 piezas de 4,5 - 10,0 mm
 en bolsa de tela esterilizable por ebullicion

 serie di 6 pezzi da 4,5 - 10,0 mm
 in busta di tela sterilizzabile

HANK	mm	Fig. US.
STI-30-8345	3,5/ 4	7/ 8
STI-30-8346	4,5/ 5	9/10
STI-30-8347	5,5/ 6	11/12
STI-30-8348	6,5/ 7	13/14
STI-30-8349	7,5/ 8	15/16
STI-30-8350	8,5/ 9	17/18
STI-30-8351	9,5/10	19/20
STI-30-8352	10,5/11	21/22
STI-30-8353	11,5/12	23/24
STI-30-8354	12,5/13	25/26



PRATT
STI-30-8357

Satz mit 8 Stück von 4,5 / 5,0 - 13,6 / 14,3 mm
 in auskochbarer Stoffrolltasche

set of 8 pieces from 4,5 / 5,0 - 13,6 / 14,3 mm
 in boilable canvas roll

jeu de 8 pièces de 4,5 / 5,0 - 13,6 / 14,3 mm
 en pochette en treillis stérilisable par ébullition

juego de 8 piezas de 4,5 / 5,0 - 13,6 / 14,3 mm
 en bolsa de tela esterilizable por ebullicion

serie di 8 pezzi da 4,5 / 5,0 - 13,6 / 14,3 mm
 in busta di tela sterilizzabile

PRATT	Charr.	mm
STI-30-8358	13/15	4,5/ 5,0
STI-30-8359	17/19	5,6/ 6,3
STI-30-8360	21/23	7,0/ 7,6
STI-30-8361	25/27	8,3/ 9,0
STI-30-8362	29/31	9,6/10,3
STI-30-8363	33/35	11,0/11,6
STI-30-8364	37/39	12,3/13,0
STI-30-8365	41/43	13,6/14,3
STI-30-8366	45/47	14,9/15,6
STI-30-8367	49/51	16,3/16,9
STI-30-8368	53/55	17,6/18,3
STI-30-8369	57/59	19,9/19,6



GOODELL
STI-30-8370
 34,0 cm



WYLIE
STI-30-8371
 29,0 cm



SIMS
STI-30-8372
 29,0 cm

Hakenzangen
Tenaculum Forceps
Pincas pour abaissement du col de l'uterus
Pinzas para coger el cuello del útero
Pinze per abbassare il collo dell'utero



SCHROEDER
EV-30-8373 23,0 cm
EV-30-8374 25,0 cm



BRAUN
EV-30-8375
25,0 cm



SKENE
EV-30-8376
24,0 cm



POZZI
EV-30-8377
25,0 cm



DUPLAY
EV-30-8378
28,0 cm



STAUDE-MOORE
EV-30-8379
17,0 cm



COLLIN-POZZI
STI-30-8380
25,0 cm



BARRETT
STI-30-8381
18,0 cm



JARCHO
STI-30-8382
20,0 cm



2x2 Zähne
2x2 teeth
2x2 dents
2x2 dientes
2x2 denti

cm **SCHROEDER**
20,0 **STI-30-8383**
24,0 **STI-30-8384**



2x2 Zähne
2x2 teeth
2x2 dents
2x2 dientes
2x2 denti

SCHROEDER
STI-30-8385
24,0 cm



TIEMANN
STI-30-8386
22,0 cm

Hakenzangen
 Tenaculum Forceps
 Pinces pour abaissement du col de l'uterus
 Pinzas para coger el cuello del útero
 Pinze per abbassare il collo dell'utero

2x2 Zähne
 2x2 teeth
 2x2 dents
 2x2 dientes
 2x2 denti



MUSEUX



MUSEUX
STI-30-8387
 6 mm
 24,0 cm



MUSEUX
STI-30-8388
 8 mm
 24,0 cm



MUSEUX
STI-30-8389
 10 mm
 24,0 cm



MUSEUX
STI-30-8390
 6 mm
 24,0 cm



MUSEUX
STI-30-8391
 8 mm
 24,0 cm



MUSEUX
STI-30-8392
 10 mm
 24,0 cm

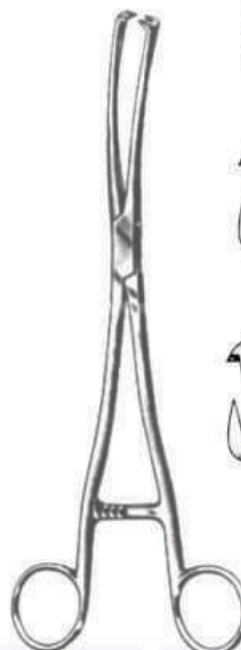

MUSEUX

2x2 Zähne
 2x2 teeth
 2x2 dents
 2x2 dientes
 2x2 denti



MUSEUX
STI-30-8393
 20,0 cm

3x4 Zähne
 3x4 teeth
 3x4 dents
 3x4 dientes
 3x4 denti



cm	TEALE
18,0	STI-30-8394
23,0	STI-30-8395
26,5	STI-30-8396



2x2 Zähne
 2x2 teeth
 2x2 dents
 2x2 dientes
 2x2 denti

JAKOBS
STI-30-8397
 21,0 cm



2x2 Zähne
 2x2 teeth
 2x2 dents
 2x2 dientes
 2x2 denti

JAKOBS
STI-30-8398
 21,0 cm



2x3 Zähne
 2x3 teeth
 2x3 dents
 2x3 dientes
 2x3 denti

HENROTIN
STI-30-8399
 20,5 cm



4x4 Zähne
 4x4 teeth
 4x4 dents
 4x4 dientes
 4x4 denti

PRATT
STI-30-8401
 28,0 cm



4x4 Zähne
 4x4 teeth
 4x4 dents
 4x4 dientes
 4x4 denti

CZERNY
STI-30-8402
 21,0 cm



4x4 Zähne
 4x4 teeth
 4x4 dents
 4x4 dientes
 4x4 denti

BRAUN
STI-30-8403
 15,5 cm

Hakenzangen
Tenaculum Forceps
Pincés pour abaissement du col de l'uterus
Pinzas para coger el cuello del útero
Pinze per abbassare il collo dell'utero



4x4 Zähne
4x4 teeth
4x4 dents
4x4 dientes
4x4 denti

PRATT
STI-30-8404
26,0 cm



5x6 Zähne
5x6 teeth
5x6 dents
5x6 dientes
5x6 denti

IOWA
STI-30-8405
26,0 cm



NOTO
STI-30-8406
27,0 cm



DOYEN
STI-30-8407
20,0 cm



KELLY
STI-30-8408
32,0 cm

Uterus-Faßzangen
Uterine Elevating Forceps
Pinces hystérolabes
Pinzas para el útero
Pinzas per afferrare l'utero



DARTIGUES
STI-30-8409
27,0 cm



SOMER
STI-30-8410
23,0 cm



COLLIN
STI-30-8411
25,0 cm



COLLIN
STI-30-8412
28,0 cm



COLLIN
STI-30-8412
25,0 cm



BUMM
STI-30-8413
28,0 cm



SIEGLER HELLMANN
STI-30-8414
24,0 cm

Uterussonden, Uterusdepressor
 Uterine Sounds, Uterine Depressor
 Hystéromètres, Dépresseur utérin
 Histerómetros, Depresor uterino
 Isterometri, Depressore uterino



Anniotom
 Anniotome
 Anniotome
 Anniótomo
 Anniotomo



BRAUN
STI-30-8416
 28 cm



Uterus-Depressoren
 Uterine Depressors
 Dépresseurs utérins
 Depressores uterinos
 Depressori uterini



SIMS
STI-30-8417
 26 cm

BEACHMANN
STI-30-8415
 26 cm

SURGITECH
 INSTRUMENTS



starr
 rigid
 rigide
 rigida
 rigida
SIMS
STI-30-8418 32 cm

Uterus-Sonden
 Uterine Sounds
 Hystéromètres
 Histerómetros
 Isterometri



starr
 rigid
 rigide
 rigida
 rigida
MARTIN
STI-30-8420 32 cm



COLLIN
STI-30-8422
 28 cm



VALLEIX
STI-30-8423
 29,5 cm

biegsam
 malleable
 malléable
 maleable
 malleabile
STI-30-8419

biegsam
 malleable
 malléable
 maleable
 malleabile
STI-30-8421



RANDALL
 EV-30-8424
 24 cm/4 mm



mm	NOVAK
1	STI-30-8425
2	STI-30-8426
3	STI-30-8427
4	STI-30-8428



mit Korb
 with basket
 avec grille
 con cesto
 con cestino

	KEVORKIAN	
STI-30-8429	1,2 mm	
STI-30-8430	4,0 mm	STI-30-8431
	30 cm	

Probeexcisionszangen
Biopsy Specimen Forceps
Pincés amporte-pièce pour le col de l'utérus
Pinzas sacabocado para el cuello del útero
Pinze taglianti per biopsia



FAURE
STI-30-8432
21 cm

cm **SCHUBERT**
21 **STI-30-8433**
28 **STI-30-8434**

SCHUBERT
STI-30-8435
26 cm



THOMS-GAYLOR
STI-30-8436 23,5 cm
STI-30-8437 21,0 cm



GELLHORN
STI-30-8438
23 cm

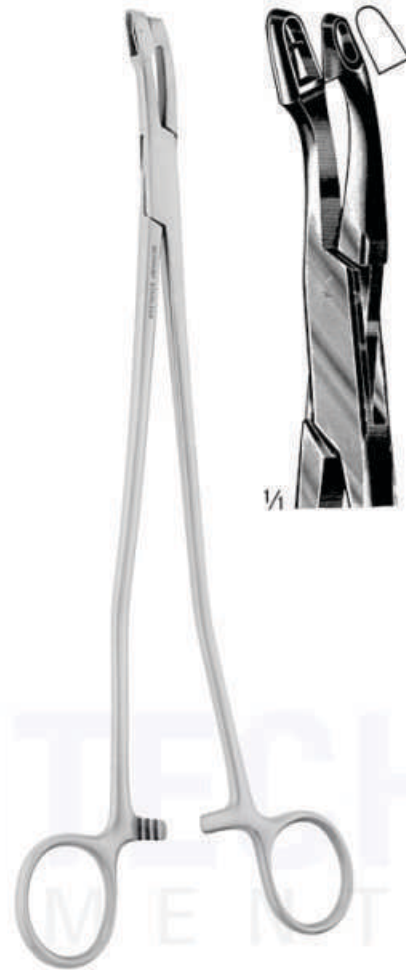

van DOREN
STI-30-8439
25 cm

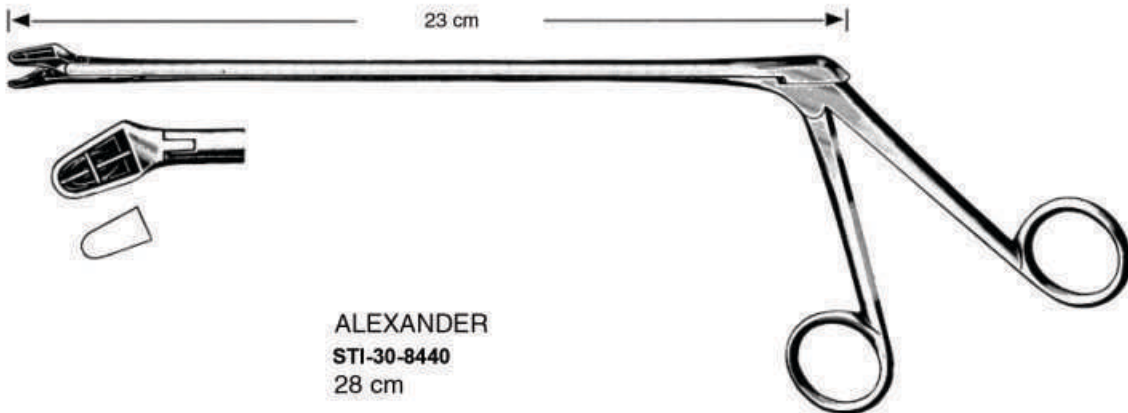

ALEXANDER
STI-30-8440
28 cm

Biopsiezangen
Biopsy Specimen Forceps
Pincas à biopsie
Pinzas sacabocado p. biopsia
Pinze per biopsia

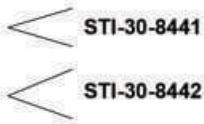

SCHUMACHER
STI-30-8441 - STI-30-8442
24 cm

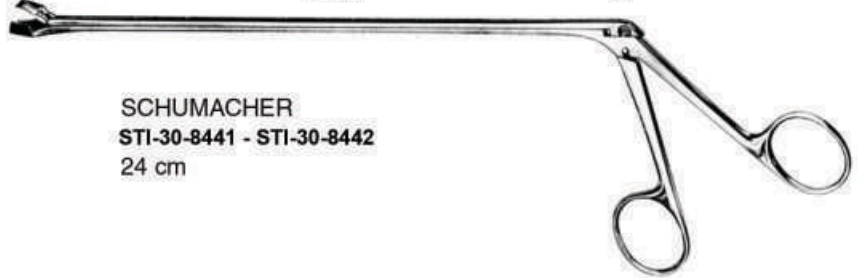

KEVORKIAN (YOUNGE)
STI-30-8443
24,5 cm



WITTNER
STI-30-8444 23 cm STI-30-8445

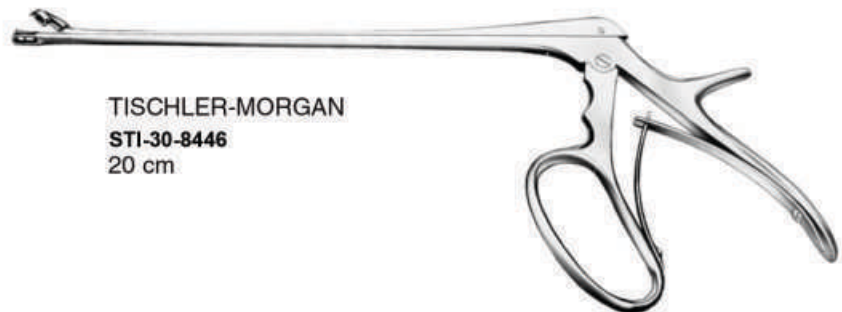

TISCHLER-MORGAN
STI-30-8446
20 cm



oval
7 x 5 mm

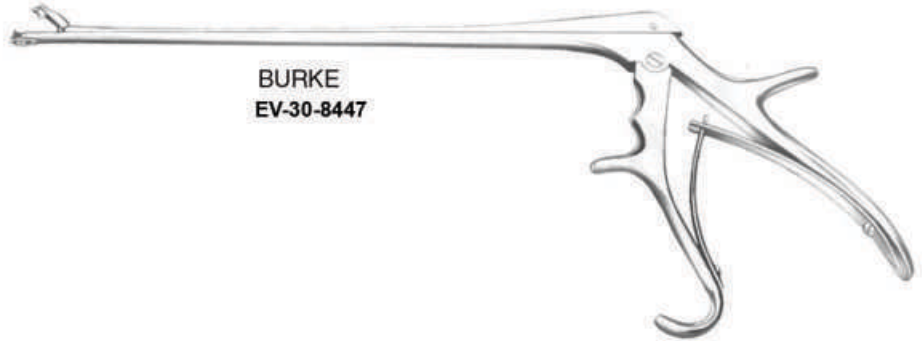

BURKE
EV-30-8447



TISCHLER Morgan

Fig. 1



Instr. kompl.	Aufsatz allein
compl. instr.	Tip only
Instrum. compl.	Embout seul
Strumento completo	Punta sola

Fig.	TOWNSEND	
1	STI-30-8448	STI-30-8452
3	STI-30-8449	STI-30-8453
4	STI-30-8450	STI-30-8454
5	STI-30-8451	STI-30-8455

STI-30-8456
Griff allein
handle only
manche seul
manico solo
mango suelto



Fig. 3

oval ● 3,7 x 5 mm



mini

Fig. 5



KEVORKAN

Fig. 4



3 x 8 mm

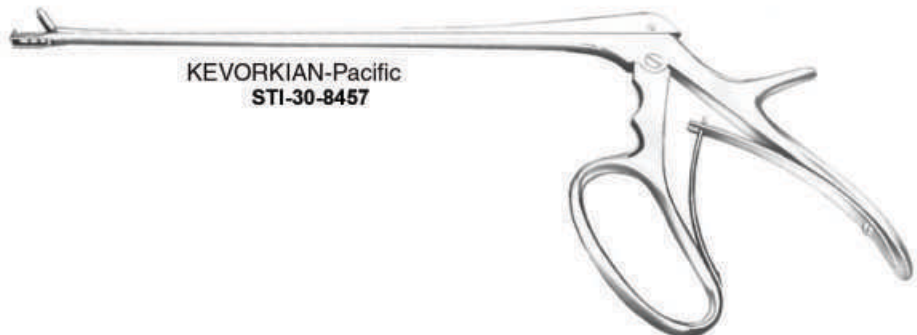

KEVORKIAN-Pacific
STI-30-8457

Biopsiezangen
Biopsy Specimen Forceps
Pincès à biopsie
Pinças sacabocado p. biopsia
Pinze per biopsia



■ 2,3 x 4,2 mm

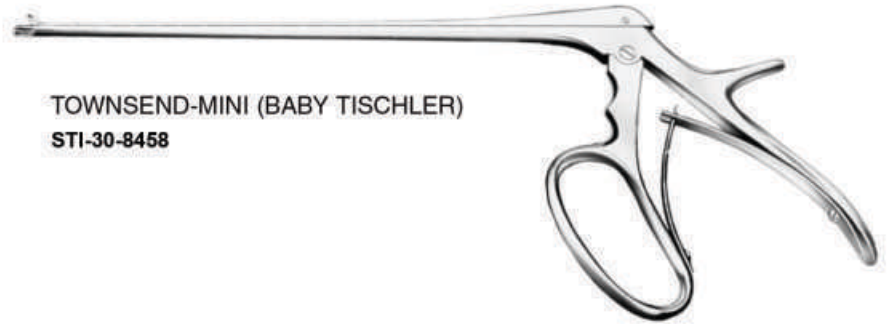

TOWNSEND-MINI (BABY TISCHLER)
STI-30-8458



■ 3,0 x 9,5 mm



TISCHLER-KEVORKIAN
STI-30-8459



● 4,0 x 6,5 mm



BAGGISH
STI-30-8460



■ 4,5 x 8 mm

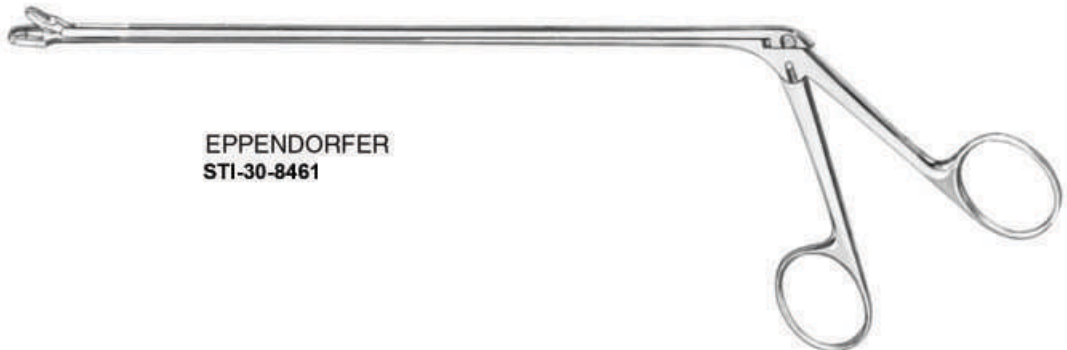

EPPENDORFER
STI-30-8461

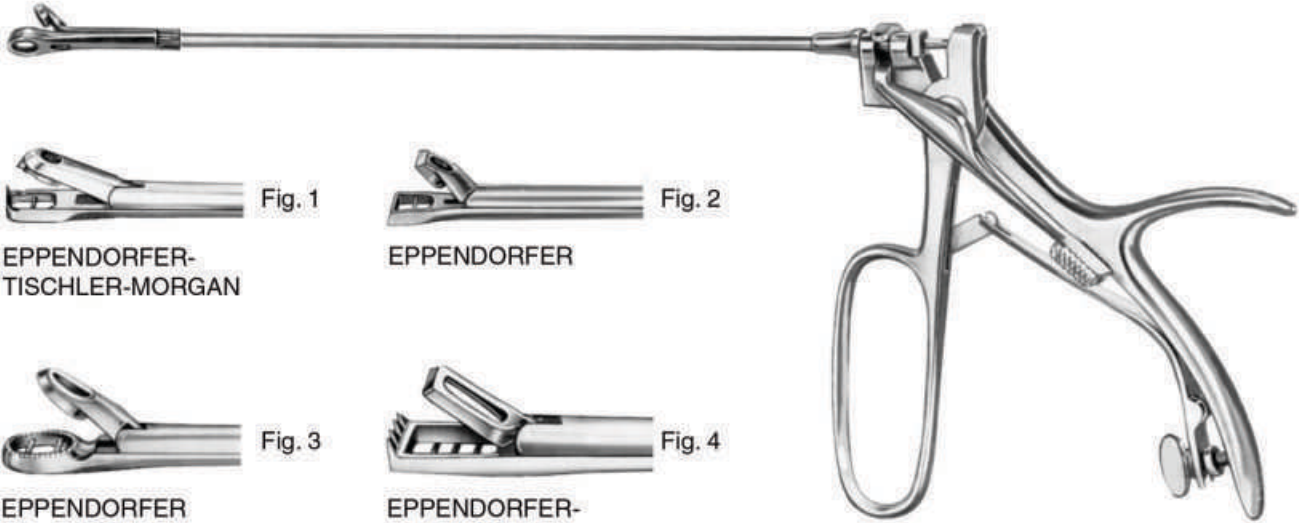

Fig. 1
EPPENDORFER-TISCHLER-MORGAN

Fig. 2
EPPENDORFER

Fig. 3
EPPENDORFER

Fig. 4
EPPENDORFER-KERVORKIAN

Fig.	Instr. kompl. compl. instr. Instrum. compl. Strumento completo	Aufsatz allein Tip only Embout seul Punta sola
1	STI-30-8462	STI-30-8466
2	STI-30-8463	STI-30-8467
3	STI-30-8464	STI-30-8468
4	STI-30-8465	STI-30-8469

Myom-Heber
Myoma Screw
Tracteur pour fibromes
Tirabuzón para fibromas
Tiramiomi



DOYEN
STI-30-8470
15 cm

Myommesser
Myoma knives
Evidens pour fibromes
Cuchillo para fibromas
Bisturi per fibromi



SEGOND
STI-30-8471
27 cm



EMMET
22 cm



STI-30-8472
Fig. 1



STI-30-8473
Fig. 2



STI-30-8474
Fig. 3



STI-30-8475
Fig. 4



STI-30-8476
Fig. 5

Fistelhaken
Fistula Hooks
Crochets pour fistules
Ganchos para fistulas
Unicini per fistole



SCHULTZE
STI-30-8477
compl.

im Holzetui
in wooden case
en boîte de bois
en estuche de madera
in scatola di legno

SCHULTZE
STI-30-8478

ohne Manometer
without manometer
sans manomètre
sin manómetro
senza manometro

SCHULTZE
STI-30-8479

Manometer zum Salpingograph
Manometer for Salpingograph
Manomètre pour salpingographe
Manómetro para salpingógrafo
Manometro per salpingografo

scharf
 sharp
 tranchant
 cortante
 tagliente

Fig.	SIMON
1	STI-30-8480
2	STI-30-8481
3	STI-30-8482
4	STI-30-8483
5	STI-30-8484
6	STI-30-8485

25 cm



Fig.	SCHROEDER
1	STI-30-8486
2	STI-30-8487
3	STI-30-8488
4	STI-30-8489
5	STI-30-8490
6	STI-30-8491

31 cm

 scharf/stumpf
 sharp/blunt
 tranchant/mousse
 cortante/roma
 tagliente/smussa

Fig.	BLAKE
1	STI-30-8492

27 cm



Fig.	GOURDET
1	STI-30-8493
2	STI-30-8494
3	STI-30-8495
4	STI-30-8496
5	STI-30-8497

28 cm

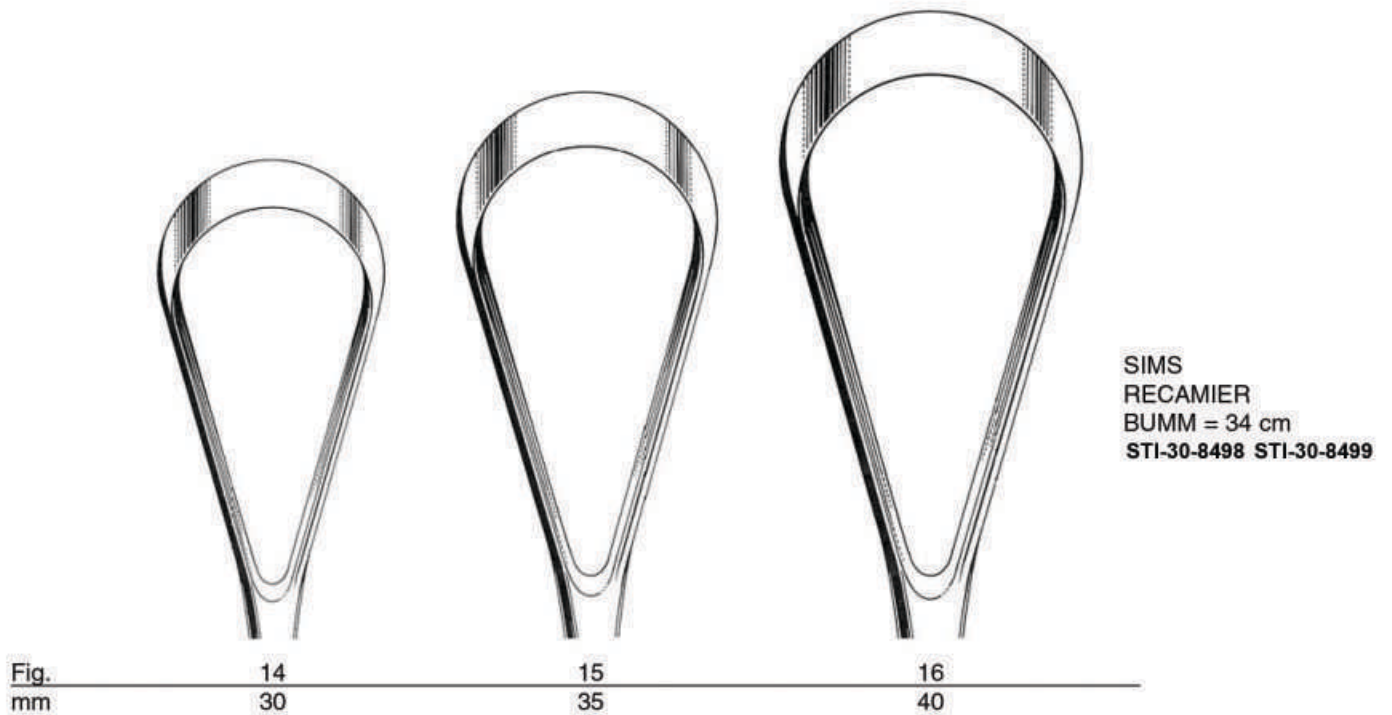
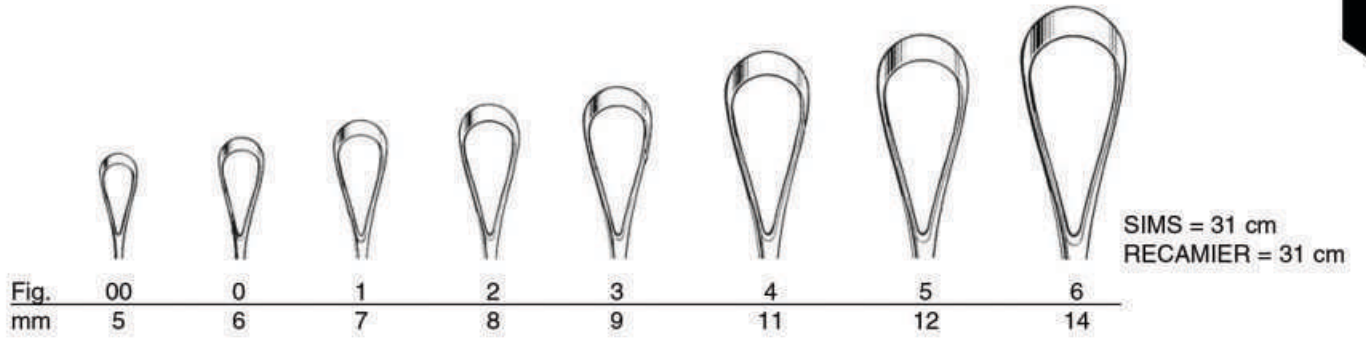



SIMS
STI-30-84500 STI-30-84501
31 cm



RECAMIER
STI-30-84503 STI-30-84504
31 cm



BUMM
STI-30-84505 STI-30-84506
34 cm

Ausführung	scharf	stumpf
Features	sharp	blunt
Exécution	tranch.	mousse
Ejecución	cut.	roma
Esecuzione	tagl.	smussa
fest/rig.	A	B
flex./fless.	C	D

Fig.	A	B	C	D	A	B	C	D	A	B	C	D
00	STI-30-84507	STI-30-84516	STI-30-84524	STI-30-84532	STI-30-84540	STI-30-84552	STI-30-84564	STI-30-84576				
0	STI-30-84508	STI-30-84517	STI-30-84525	STI-30-84533	STI-30-84541	STI-30-84553	STI-30-84565	STI-30-84577				
1	STI-30-84510	STI-30-84518	STI-30-84526	STI-30-84534	STI-30-84542	STI-30-84554	STI-30-84566	STI-30-84578				
2	STI-30-84511	STI-30-84519	STI-30-84527	STI-30-84535	STI-30-84543	STI-30-84555	STI-30-84567	STI-30-84579				
3	STI-30-84512	STI-30-84520	STI-30-84528	STI-30-84536	STI-30-84544	STI-30-84556	STI-30-84568	STI-30-84580				
4	STI-30-84513	STI-30-84521	STI-30-84529	STI-30-84537	STI-30-84545	STI-30-84557	STI-30-84569	STI-30-84581				
5	STI-30-84514	STI-30-84522	STI-30-84530	STI-30-84538	STI-30-84546	STI-30-84558	STI-30-84570	STI-30-84582				
6	STI-30-84515	STI-30-84523	STI-30-84531	STI-30-84539	STI-30-84547	STI-30-84559	STI-30-84571	STI-30-84583				
7					STI-30-84548	STI-30-84560	STI-30-84572	STI-30-84584				
8					STI-30-84549	STI-30-84561	STI-30-84573	STI-30-84585				
9					STI-30-84550	STI-30-84562	STI-30-84574	STI-30-84586				
10					STI-30-84551	STI-30-84563	STI-30-84575	STI-30-84587				STI-30-84597
14									STI-30-84588	STI-30-84591	STI-30-84594	STI-30-84598
15									STI-30-84589	STI-30-84592	STI-30-84595	STI-30-84599
16									STI-30-84590	STI-30-84593	STI-30-84596	STI-30-84600



STI-30-84608

Kupplungsstück
Coupling Piece
Pièce de raccordement
Pieza de acoplamiento
Pezzo di collegamento



Tubenaßpinzette
Tubal seizing forceps
Pince a saisir les trompes
Pinza para sostener trompas
Pinze per afferare trompe

29 cm

STI-30-84601	Ø 3,0 mm
STI-30-84602	Ø 4,0 mm
STI-30-84603	Ø 6,0 mm
STI-30-84604	Ø 8,0 mm
STI-30-84605	Ø 10,0 mm
STI-30-84606	Ø 12,0 mm
STI-30-84607	Ø 14,0 mm

NEUBÜSSER

20 cm

STI-30-84609	Ø 6,0 mm
STI-30-84610	Ø 8,0 mm
STI-30-84611	Ø 10,0 mm



Obstetrics

Geburtszangen für section caesares (Schnittentbindung)
 Forceps for caesarean section
 Forceps pour césarienne
 Fórceps para operación cesárea
 Forcipi per tagli cesarei



cm WRIGLEY
 23 STI-31-84612
 28 STI-31-84613



SIMPSON
 STI-31-84614
 30 cm



SIMPSON
 STI-31-84615
 23 cm



cm SIMPSON-BRAUN
 33 STI-31-84616
 36 STI-31-84617



De LEE
 STI-31-84618
 30 cm



cm De LEE
 36 STI-31-84619
 39 STI-31-84620



KIELLAND
 STI-31-84621
 41 cm



cm ELLIOT
 32 STI-31-84622
 38 STI-31-84623



cm NAEGELE
36 **STI-31-84624**
40 **STI-31-84625**



LUIKART
STI-31-84626
40 cm



KIELLAND-LUIKART
STI-31-84627
40 cm



SIMPSON-LUIKART
STI-31-84628
36 cm



McLEAN-TUCKER-LUIKART
STI-31-84629
40 cm



McLEAN-TUCKER
STI-31-84630
39 cm



McLEAN-LUIKART
STI-31-84631
39 cm



McLEAN
STI-31-84632
36 cm



BARTON
STI-31-84633
36 cm



BARTON
STI-31-84634
17 cm



BOERMA
STI-31-84635
29 cm



PIPER
STI-31-84636
44 cm

für nachkommenden Kopf bei Steisslagen
for delivery of the after coming head in breech presentation
Spatules pour dégager la tête
Especialmente para partos en presentación de nalgas
Speciale in parti con prentazione di podice



PIPER
STI-31-84637
40 cm



DEWEY
STI-31-84638
 37 cm

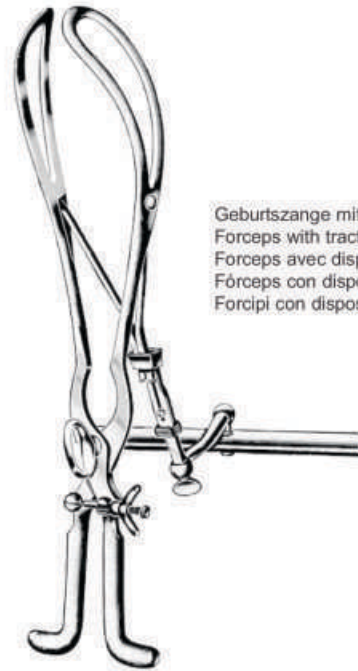

TARNIER
STI-31-84639
 40 cm

Geburtszange mit Achsenzugvorrichtung
 Forceps with traction rod
 Forceps avec dispositif de traction
 Fórceps con dispositivo de tracción
 Forcipi con dispositivo di trazione

Kopfhebel für unteres Segment bei Kaiserschnitt
 Head extractor for use in lower segment in caesarean operation
 Levier à tête utilisé en cas de césarienne
 Elevador para cabeza usándose en el segmento inferior del útero
 en casos de operaciones cesáreas
 Elevatore per testa in interventi con taglio cesareo



MURLESS
STI-31-84640



BILL
STI-31-84641

Zughebel, passend für alle Geburtszangen mit
 gehorntem Standard-Griff
 Traction handle to be used with all forceps
 with standard type handle
 Tracteurs pour tous les forceps avec manches
 ordinaires
 Tractor adecuado para todas las fórceps con
 mango standard
 Manico a trazione adatto a tutte le forcipi con
 manico standard



LUIKART-BILL
STI-31-84642
 21 cm

Uterusklemmzange zur Blutstillung
 Caesarean section haemostatic forceps
 Pince-clamp utérine pour hémostase
 Pinza-clamp uterina para hemostasis
 Pinza emostatiche per tagli cesarei



SMELLIE
STI-31-84643
 33 cm



GAUSS
STI-31-84644
 27 cm



GREEN-ARMYTAGE
STI-31-84645
 21 cm

Nabelschnurklemmen
 Umbilical Cord Clamps
 Clamps p. cordon ombilical
 Clamps umbilicales
 Pinze ombelicali



COLLIN
STI-31-84646
 9 cm

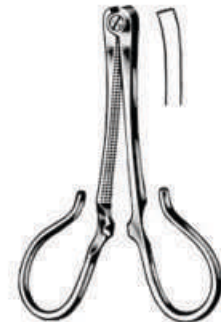

KANE
STI-31-84647
 8,5 cm



MARTIN
STI-31-84648
 34 cm



COLLIER
STI-31-84649
 30 cm



COLLIN
STI-31-84650
 35 cm



— SAENGER —
STI-31-84651 STI-31-84652



— WINTER —
28 cm
Fig.
STI-31-84653 1 STI-31-84656
STI-31-84654 2 STI-31-84657
STI-31-84655 3 STI-31-84658



— WINTER — Fig.
STI-31-84659 2
STI-31-84660 3

mit Sperre
with ratchet
avec crémaillère
con cremallera
con cremagliera



— LEWKOWITZ —
STI-31-84661 STI-31-84662



McCLINTOCK
STI-31-84663
24 cm

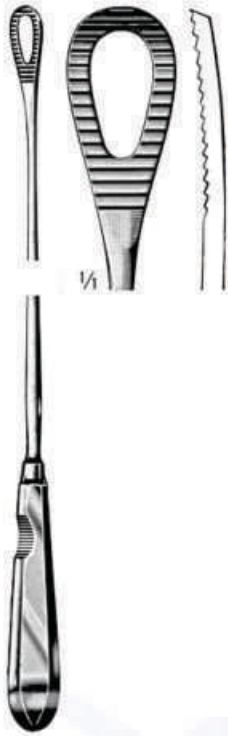

PESTALOZZA
STI-31-84664
30 cm

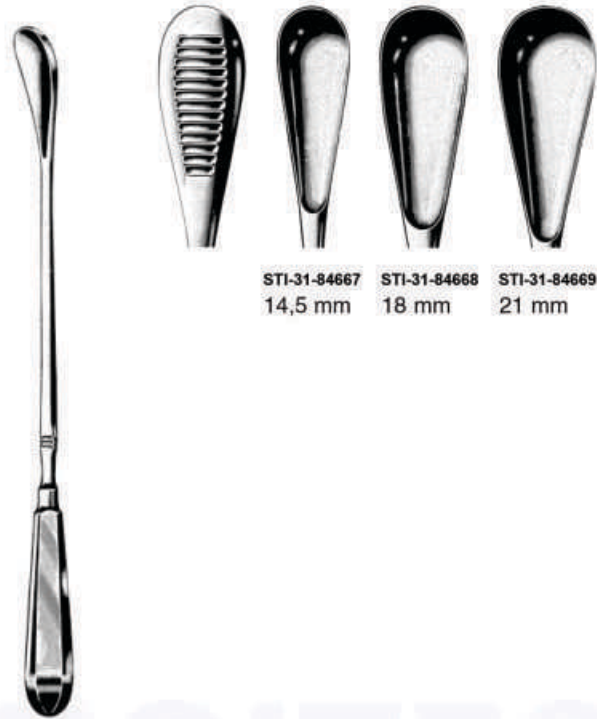

STI-31-84667 14,5 mm
STI-31-84668 18 mm
STI-31-84669 21 mm

CUZZI
STI-31-84665 STI-31-84666
30 cm



WALLICH
STI-31-84670
42 cm



SELLHEIM
STI-31-84671
28 cm



BRAUN
STI-31-84672
42 cm

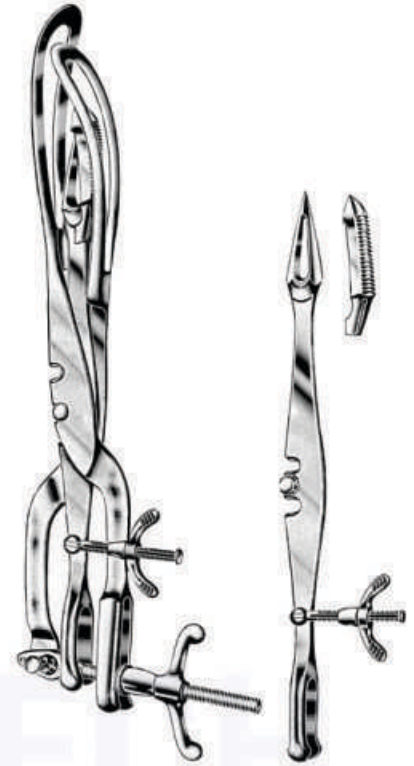

TARNIER
STI-31-84673
46 cm



Perforatorium
Perforator
Perce-crâne
Perfora-crâneos
Spezzacraneo

SPELLIE
STI-31-84674
25 cm



NÄGELE
STI-31-84675
25 cm



Dekapitationshaken
Decapitating hook
Crochet pour décapitation
Gancho para decapitación
Uncino per detroncazione

BRAUN
STI-31-84676
30 cm



Dermatology, Hygiene



KILNER
STI-32-84677
15 cm



SCHAMBERG
STI-32-84678
10 cm



UNNA
STI-32-84679
14 cm



UNNA
STI-32-84680
14 cm



WALTON
STI-32-84681
14 cm



SAALFELD
STI-32-84682
10 cm

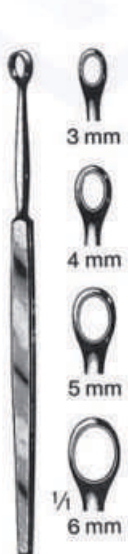

mm	FOX
3	STI-32-84683
4	STI-32-84684
5	STI-32-84685
6	STI-32-84686

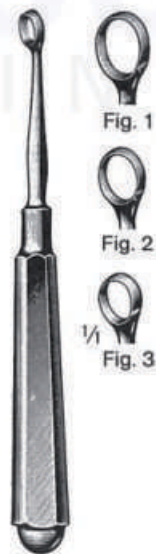
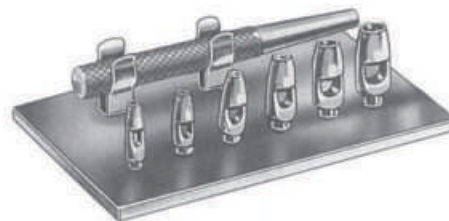
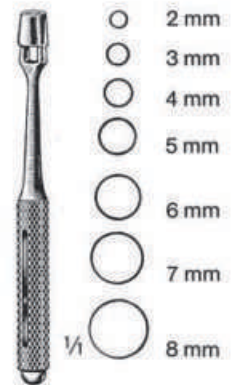

Fig.	PIFFARD
1	STI-32-84687
2	STI-32-84688
3	STI-32-84689



KEYES
STI-32-84690
compl.



mm	KEYES
2	STI-32-84691
3	STI-32-84692
4	STI-32-84693
5	STI-32-84694
6	STI-32-84695
7	STI-32-84696
8	STI-32-84697



STI-32-84698

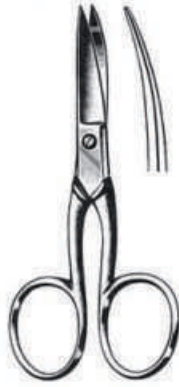

STI-32-84699 10 cm STI-32-84700



STI-32-84701
14 cm



STI-32-84702
14 cm



cm **TURNBULL**
11,5 STI-32-84703
13,5 STI-32-84704



STI-32-84705
13 cm



STI-32-84706
11 cm



STI-32-84707
10,5 cm



STI-32-84708
10 cm



STI-32-84709
10 mm



cm
10 STI-32-84710
12 STI-32-84711



CREDO
STI-32-84712
14,5 cm

74.396.00
10 Ersatzklingen
10 Spare Blades
10 lames de rechange
10 hojas de repuesto
10 lame di ricambio

Different Containers



Nadeldosen
 Needle Cases
 Boites pour aiguilles
 Estuches para agujas
 Scatole per aghi

18/10
 Edelstahl rostfrei
 Stainless Steel
 Acier inoxydable
 Acero inoxidable
 Acciaio inossidabile

komplett mit perforierter Innendose
 complete with perforated interior box
 complet avec boite interieure perforée
 completo con caja interior perforada
 completo con scatola interiore perforata



STI-33-84713
 65x15 mm

Innendose
 Deckel und Boden perforiert
 Interior Box
 perforated lid and bottom
 Boite intérieure
 couvercle et fond perforé
 Caja interior
 tapa y fondo perforado
 Scatola interiore
 coperchio e fondo perforati



STI-33-84714

Nadelkassetten
 Needle Cases
 Boites pour aiguilles
 Estuches para agujas
 Scatole per aghi

Deckel und Boden perforiert
 perforated lid and bottom
 couvercle et fond perforé
 tapa y fondo perforado
 coperchio e fondo perforati



SAUERBRUCH
 STI-33-84715
 210x125x17 mm

Deckel und Boden perforiert
 perforated lid and bottom
 couvercle et fond perforé
 tapa y fondo perforado
 coperchio e fondo perforati



STI-33-84716
 150x95x13 mm

Deckel ohne Knopf
 lid without knob
 couvercle sans bouton
 tapa sin botón
 coperchio senza bottone



Instrumentenkästen
 Instrument Boxes
 Boîtes pour instruments
 Cajas para instrumentos
 Scatole per strumenti

	L x B x H
STI-33-84717	165x 85x 35 mm
STI-33-84718	200x100x 60 mm
STI-33-84719	220x120x 60 mm
STI-33-84720	230x130x 50 mm
STI-33-84721	260x150x 50 mm
STI-33-84722	280x140x 60 mm
STI-33-84723	500x200x120 mm

mit Knopfdeckel
 lid with knob
 avec couvercle à bouton
 tapa con botón
 con coperchio a bottone



Instrumentenkästen
 Instrument Boxes
 Boîtes pour instruments
 Cajas para instrumentos
 Scatole per strumenti

	L x B x H
STI-33-84724	320x100x50 mm
STI-33-84725	430x100x35 mm

mit Knopfdeckel
 lid with knob
 avec couvercle à bouton
 tapa con botón
 con coperchio a bottone



Instrumentenkästen
 Instrument Boxes
 Boîtes pour instruments
 Cajas para instrumentos
 Scatole per strumenti

	L x B x H
STI-33-84726	170x120x60 mm
STI-33-84727	200x 60x40 mm
STI-33-84728	220x100x50 mm
STI-33-84729	220x140x60 mm
STI-33-84730	270x170x60 mm
STI-33-84731	300x180x65 mm



Wattspender
 Cotton dispensers
 Distributeurs de coton
 Dispensores de algodón
 Distributore del cotone

	Ø x H	
STI-33-84732	75x	60 mm
STI-33-84733	75x	75 mm
STI-33-84734	100x	60 mm
STI-33-84735	100x	100 mm
STI-33-84736	125x	80 mm
STI-33-84737	125x	125 mm
STI-33-84738	150x	150 mm

Metallschalen
 Stainless Steel Bowls
 Cuvettes de acier inoxydable
 Cubetas de acero inoxidable
 Scodelle di acciaio inossidabile



	Ø x H		
STI-33-84739	40x	19 mm	(0.05 Liter)
STI-33-84740	61x	30 mm	(0.07 Liter)
STI-33-84741	80x	40 mm	(0.14 Liter)
STI-33-84742	116x	50 mm	(0.35 Liter)
STI-33-84743	128x	55 mm	(0.45 Liter)
STI-33-84744	147x	65 mm	(0.70 Liter)
STI-33-84745	157x	75 mm	(1.10 Liter)
STI-33-84746	187x	85 mm	(1.60 Liter)

Metallschalen
 Stainless Steel Bowls
 Cuvettes de acier inoxydable
 Cubetas de acero inoxidable
 Scodelle di acciaio inossidabile



	Ø x H	
STI-33-84747	42x	30 mm
STI-33-84748	53x	34 mm
STI-33-84749	58x	40 mm
STI-33-84750	64x	48 mm
STI-33-84751	68x	47 mm
STI-33-84752	71x	46 mm
STI-33-84753	71x	50 mm
STI-33-84754	81x	51 mm
STI-33-84755	81x	54 mm
STI-33-84756	89x	47 mm
STI-33-84757	100x	48 mm
STI-33-84758	100x	53 mm

 Waschschüsseln
 Wash Bowls
 Cuvettes
 Palanganas
 Scodelle per liquidi

	Ø x H
STI-33-84759	300x100 mm
STI-33-84760	350x100 mm
STI-33-84761	400x100 mm
STI-33-84762	330x 90 mm
STI-33-84763	330x115 mm

 Runde Schüsseln
 Round Bowls
 Cuvettes rondes
 Cubetas redondas
 Scodelle rotonde

	Ø x H	
STI-33-84764	150x 74 mm	(0.75 Liter)
STI-33-84765	160x 65 mm	(1.00 Liter)
STI-33-84766	220x 70 mm	(2.00 Liter)
STI-33-84767	230x 80 mm	(2.50 Liter)
STI-33-84768	260x130 mm	(4.50 Liter)
STI-33-84769	255x115 mm	(3.50 Liter)
STI-33-84770	275x115 mm	(5.00 Liter)
STI-33-84771	300x105 mm	(6.00 Liter)
STI-33-84772	400x150 mm	(14.00 Liter)

 Spülschale
 Solution Bowls
 Cuvettes rondes
 Cubetas redondas
 Scodelle rotonde

	Ø x H
STI-33-84773	300x120 mm
STI-33-84774	350x130 mm
STI-33-84775	400x140 mm

 Irrigatoren
 Irrigator
 Irrigateurs
 Irrigadores
 Irrigatori

STI-33-84776	1.00 Liter
STI-33-84777	1.50 Liter
STI-33-84778	2.00 Liter



Stechbecken, amerik. Form
 Bed pan (american pattern)
 Bassin de lit (modèle américain)
 Silletas (forma americana)
 Padelle (modello americano)

	L x B x H
STI-33-84779	380x230x95 mm
STI-33-84780	350x270x100 mm



Stechbecken
 Bed pan
 Bassin de lit
 Silletas
 Padelle

	Ø
STI-33-84781	235 mm
STI-33-84782	310 mm



Stechbecken
 Bed pan
 Bassin de lit
 Silletas
 Padelle

	L x B x H	
STI-33-84783	300x200x 75 mm	Small (with handle)
STI-33-84784	300x200x 75 mm	Small (without handle)
STI-33-84785	350x230x100 mm	Large (with handle)



Sputumbecher
 Sputum Cup
 Crachoir
 Escupideria
 Sputacchiera

	Ø x H
STI-33-84786	100x50 mm

 Nierenschalen
 Kidney bowls
 Bassins réniformes
 Riñoneras
 Padelle reniformi

	L x B x H
STI-33-84787	170x100x30 mm
STI-33-84788	200x120x35 mm
STI-33-84789	250x140x40 mm
STI-33-84790	275x150x50 mm
STI-33-84791	300x160x50 mm
STI-33-84792	400x200x60 mm

 Trichter
 Funnels
 Entonnoires
 Embudos
 Imbuti

	Ø x H
STI-33-84793	100x100 mm
STI-33-84794	150x150 mm

 Medizinbecher
 Medicine Cups
 Gobelets
 Vasos graduados
 Bicchieri per medicinali

	Ø x H	
STI-33-84795	58x30 mm	25ml
STI-33-84796	52x50 mm	50ml
STI-33-84797	65x55 mm	100ml

 Meßbecher
 Measuring jugs
 Gobelets gradués
 Copas graduadas
 Misurino

STI-33-84798	0.25 Liter
STI-33-84799	0.50 Liter
STI-33-84800	1.00 Liter
STI-33-84801	2.00 Liter



Petrischalen
 Petri Dishes
 Boîtes de Petri
 Cápsulas de Petri
 Scodella di Petri

	Ø x H
STI-33-84802	60x20 mm
STI-33-84803	90x15 mm
STI-33-84804	100x20 mm
STI-33-84805	120x20 mm



Standgefäße
 Metal Jars
 Récipients en métal
 Tarros metálicos
 Recipienti metallici

	Ø x H
STI-33-84806	30x 90 mm
STI-33-84807	50x100 mm
STI-33-84808	50x130 mm
STI-33-84809	50x175 mm
STI-33-84810	75x100 mm
STI-33-84811	75x130 mm
STI-33-84812	75x175 mm
STI-33-84813	100x175 mm
STI-33-84814	100x200 mm



Instrumenttablets
 Instrument Trays
 Plateaux pour instruments
 Bandejas para instrumentos
 Bacinelle per strumenti

	L x B x H
STI-33-84815	190x100x13 mm
STI-33-84816	200x100x13 mm



Instrumenttablets
 Instrument Trays
 Plateaux pour instruments
 Bandejas para instrumentos
 Bacinelle per strumenti

	L x B x H
STI-33-84817	190x100x13 mm
STI-33-84818	200x100x13 mm
STI-33-84819	450x300x32 mm

 Instrumententablets
 Instrument Trays
 Plateaux pour instruments
 Bandejas para instrumentos
 Bacinelle per strumenti

	L x B x H
STI-33-84820	200x150x25 mm
STI-33-84821	230x155x30 mm
STI-33-84822	300x175x30 mm
STI-33-84823	300x175x40 mm
STI-33-84824	300x200x50 mm
STI-33-84825	350x220x40 mm
STI-33-84826	400x300x50 mm
STI-33-84827	450x350x50 mm

 Instrumententablets
 Instrument Trays
 Plateaux pour instruments
 Bandejas para instrumentos
 Bacinelle per strumenti

	L x B x H
STI-33-84828	210x160x10 mm
STI-33-84829	240x180x10 mm
STI-33-84830	290x190x10 mm
STI-33-84831	310x150x10 mm
STI-33-84832	300x200x20 mm
STI-33-84833	300x245x16 mm
STI-33-84834	350x240x10 mm
STI-33-84835	385x265x16 mm
STI-33-84836	385x210x10 mm
STI-33-84837	400x270x20 mm
STI-33-84838	420x280x10 mm
STI-33-84839	430x295x16 mm
STI-33-84840	485x320x16 mm
STI-33-84841	510x380x30 mm
STI-33-84842	590x380x30 mm

 Mehrzweckschalen
 Universal Trays
 Plateaux universaux
 Bandejas universales
 Bacinelle universali

	L x B x H
STI-33-84843	220x170x50 mm
STI-33-84844	300x175x30 mm
STI-33-84845	300x175x40 mm
STI-33-84846	300x200x50 mm
STI-33-84847	350x240x36 mm
STI-33-84848	400x300x50 mm
STI-33-84849	450x350x50 mm



Urinal für Männer
 Urinal male
 Urinal homme
 Urinal hombre
 Urinale uomo

	L x B x H
STI-33-84850	230x150x85 mm



Urinal für Frauen
 Urinal female
 Urinal femme
 Urinal mujer
 Urinale donna

	L x B x H
STI-33-84851	230x150x85 mm



Urinal
 Urinal
 Urinal
 Urinal
 Urinale

	Ø x H
STI-33-84852	230x115 mm



Becher
 Cups
 Récipients
 Tarros
 Recipienti

	Ø x H	
STI-33-84853	75x 75 mm	0.25 Liter
STI-33-84854	100x 85 mm	0.50 Liter
STI-33-84855	115x100 mm	0.75 Liter
STI-33-84856	125x125 mm	1.00 Liter



Abfalleimer
 Waste Bucket
 Seaux pour déchets
 Cobo para desechos
 Secchi per rifiuti

STI-33-84857	10.00 Liter
STI-33-84858	13.00 Liter
STI-33-84859	15.00 Liter
STI-33-84860	18.00 Liter



Abfalleimer
 Waste Bucket
 Seaux pour déchets
 Cobo para desechos
 Secchi per rifiuti

STI-33-84861	210 mm
STI-33-84862	240 mm
STI-33-84863	270 mm
STI-33-84864	300 mm

Sterilisiertrommeln
 Sterilizing Drums
 Tambours à stérilisation
 Tambores p. esterilización
 Tambori p. sterilizzazione

18/10
 Edelstahl rostfrei
 Stainless Steel
 Acier inoxydable
 Acero inoxidable
 Acciaio inossidabile



SCHIMMELBUSCH	Ø x H	KONRICH
STI-33-84865	125x 80 mm	STI-33-84907
STI-33-84866	125x100 mm	STI-33-84908
STI-33-84867	125x125 mm	STI-33-84909
STI-33-84868	150x 80 mm	STI-33-84910
STI-33-84869	150x100 mm	STI-33-84911
STI-33-84870	150x130 mm	STI-33-84912
STI-33-84871	150x150 mm	STI-33-84913
STI-33-84872	150x190 mm	STI-33-84914
STI-33-84873	190x145 mm	STI-33-84915
STI-33-84874	190x165 mm	STI-33-84916
STI-33-84875	190x190 mm	STI-33-84917
STI-33-84876	190x240 mm	STI-33-84918
STI-33-84877	240x145 mm	
STI-33-84878	240x165 mm	STI-33-84919
STI-33-84879	240x190 mm	STI-33-84920
STI-33-84880	240x240 mm	STI-33-84921
STI-33-84881	240x290 mm	STI-33-84922
STI-33-84882	240x340 mm	
STI-33-84883	240x390 mm	
STI-33-84884	290x145 mm	STI-33-84923
STI-33-84885	290x165 mm	STI-33-84924
STI-33-84886	290x190 mm	STI-33-84925
STI-33-84887	290x240 mm	STI-33-84926
STI-33-84888	290x290 mm	STI-33-84927
STI-33-84889	290x340 mm	
STI-33-84890	290x390 mm	
STI-33-84891	340x145 mm	STI-33-84928
STI-33-84892	340x165 mm	STI-33-84929
STI-33-84893	340x190 mm	STI-33-84930
STI-33-84894	340x240 mm	STI-33-84931
STI-33-84895	340x290 mm	STI-33-84932
STI-33-84896	340x340 mm	
STI-33-84897	340x390 mm	
STI-33-84898	390x145 mm	STI-33-84933
STI-33-84899	390x165 mm	STI-33-84934
STI-33-84900	390x190 mm	STI-33-84935
STI-33-84901	390x240 mm	STI-33-84936
STI-33-84902	390x290 mm	STI-33-84937
STI-33-84903	390x340 mm	STI-33-84938
STI-33-84904	390x390 mm	STI-33-84939
STI-33-84905	390x490 mm	
STI-33-84906	390x590 mm	

18/10
 Edelstahl rostfrei
 Stainless Steel
 Acier inoxydable
 Acero inoxidable
 Acciaio inossidabile

Aus Drahtgeflecht
 Wire Mesh
 En fil inox
 De alambre
 In rete metallica



Aus perforiertem Blech
 From Perforated Sheet Metal
 En tôle perforée
 De chapa de acero perforada
 In acciaio perforato



	L x B x H
STI-33-84940	240x250x 50 mm
STI-33-84941	480x250x 50 mm
STI-33-84942	550x250x 50 mm
STI-33-84943	240x250x 70 mm
STI-33-84944	480x250x 70 mm
STI-33-84945	240x250x100 mm
STI-33-84946	480x250x100 mm

	L x B x H
STI-33-84947	260x260x 50 mm
STI-33-84948	480x260x 50 mm
STI-33-84949	505x305x 40 mm



Aluminium Containers



Große Container und Zubehör
Large Containers and Accessories
Grands container et accessoires
Contenedores grandes y accesoris
Grossi container e accessori

STI-34-84950 bis 8478
STI-34-84951 to 8478
STI-34-84952 jusque 8478
STI-34-84953 hasta 8478
STI-34-84954 fino a 8478



3/4 Container und Zubehör
3/4 Containers and Accessories
3/4 Container et accessoires
3/4 Contenedores y accesorios
3/4 Container e accessori

STI-34-84955 bis 8480
STI-34-84956 to 8480
STI-34-84957 jusque 8480
STI-34-84958 hasta 8480
STI-34-84959 fino a 8480



Halb-Container und Zubehör
Half-Size-Containers and Accessories
Semi-Container et accessoires
Contenedores medianos y accesorios
Mezzi container e accessori

STI-34-84960 bis 8482
STI-34-84961 to 8482
STI-34-84962 jusque 8482
STI-34-84963 hasta 8482
STI-34-84964 fino a 8482



Flach-, Halb-, Container und Zubehör
Flat Half-Size-Containers and Accessories
Plat-, Semi-, Container et accessoires
Contenedores medianos y planos y accesorios
Piatti, Mezzi-, Container e accessori

STI-34-84965 bis 8484
STI-34-84966 to 8484
STI-34-84967 jusque 8484
STI-34-84968 hasta 8484
STI-34-84969 fino a 8484



Kleine Container und Zubehör
Small Containers and Accessories
Petit-Container et accessoires
Contenedores pequeños y accesorios
Piccoli container e accessori

STI-34-84970 bis 8486
STI-34-84971 to 8486
STI-34-84972 jusque 8486
STI-34-84973 hasta 8486
STI-34-84974 fino a 8486



Spezial Container Set und Zubehör
Special Container Set and Accessories
Spécial Container Set et accessoires
Contenedores especiales y accesorios
Container speciale e accessori

STI-34-84975
STI-34-84976
STI-34-84977
STI-34-84978
STI-34-84979



Spezial Container Set und Zubehör
Special Container Set and Accessories
Spécial Container Set et accessoires
Contenedores especiales y accesorios
Container speciale e accessori

STI-34-84980 bis 8489
STI-34-84981 to 8489
STI-34-84982 jusque 8489
STI-34-84983 hasta 8489
STI-34-84984 fino a 8489

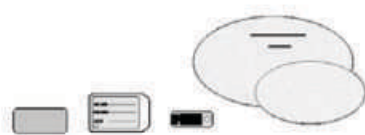

Zubehör
Accessories
Accessoires
Accesorios
Accessori

STI-34-84985 bis 8491
STI-34-84986 to 8491
STI-34-84987 jusque 8491
STI-34-84988 hasta 8491
STI-34-84989 fino a 8491

Deckel gelocht - Boden ungelocht
 Lid perforated - Bottom non perforated
 Courvercle perforé - Fond non perforé
 Tapa perforada - Fondo no perforada
 Coperchio forato - Fondo non forato

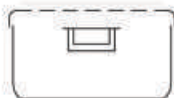

Deckel gelocht - Boden gelocht
 Lid perforated - Bottom perforated
 Courvercle perforé - Fond perforé
 Tapa perforada - Fondo perforada
 Coperchio forato - Fondo forato



580 x 280 x 100 mm



STI-34-84990 A
 STI-34-84991 B
 STI-34-84992 C
 STI-34-84993 D
 STI-34-84994 E
 STI-34-84995 F

STI-34-85020 A
 STI-34-85021 B
 STI-34-85022 C
 STI-34-85023 D
 STI-34-85024 E
 STI-34-85025 F

580 x 280 x 135 mm



STI-34-84996 A
 STI-34-84997 B
 STI-34-84998 C
 STI-34-84999 D
 STI-34-85000 E
 STI-34-85001 F

STI-34-85026 A
 STI-34-85027 B
 STI-34-85028 C
 STI-34-85029 D
 STI-34-85030 E
 STI-34-85031 F

580 x 280 x 150 mm



STI-34-85002 A
 STI-34-85003 B
 STI-34-85004 C
 STI-34-85005 D
 STI-34-85006 E
 STI-34-85007 F

STI-34-85032 A
 STI-34-85033 B
 STI-34-85034 C
 STI-34-85035 D
 STI-34-85036 E
 STI-34-85037 F

580 x 280 x 200 mm



STI-34-85008 A
 STI-34-85009 B
 STI-34-85010 C
 STI-34-85011 D
 STI-34-85012 E
 STI-34-85013 F

STI-34-85038 A
 STI-34-85039 B
 STI-34-85040 C
 STI-34-85041 D
 STI-34-85042 E
 STI-34-85043 F

580 x 280 x 260 mm



STI-34-85014 A
 STI-34-85015 B
 STI-34-85016 C
 STI-34-85017 D
 STI-34-85018 E
 STI-34-85019 F

STI-34-85044 A
 STI-34-85045 B
 STI-34-85046 C
 STI-34-85047 D
 STI-34-85048 E
 STI-34-85049 F

Sicherheitsdeckel - Boden ungelocht
 Safety Lid - Bottom non-perforated
 Courvercle de securité - Fond non perforé
 Tapa de seguridad - Fondo no perforada
 Coperchio di Protezione - Fondo non forato

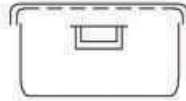

Sicherheitsdeckel - Boden gelocht
 Safety Lid - Bottom perforated
 Courvercle de securité - Fond perforé
 Tapa de seguridad - Fondo perforada
 Coperchio di Protezione - Fondo forato

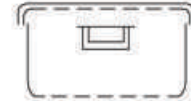

580 x 280 x 100 mm



STI-34-85050 A
STI-34-85051 B
STI-34-85052 C
STI-34-85053 D
STI-34-85054 E
STI-34-85055 F

STI-34-85080 A
STI-34-85081 B
STI-34-85082 C
STI-34-85083 D
STI-34-85084 E
STI-34-85085 F

580 x 280 x 135 mm



STI-34-85056 A
STI-34-85057 B
STI-34-85058 C
STI-34-85059 D
STI-34-85060 E
STI-34-85061 F

STI-34-85086 A
STI-34-85087 B
STI-34-85088 C
STI-34-85089 D
STI-34-85090 E
STI-34-85091 F

580 x 280 x 150 mm



STI-34-85062 A
STI-34-85063 B
STI-34-85064 C
STI-34-85065 D
STI-34-85066 E
STI-34-85067 F

STI-34-85092 A
STI-34-85093 B
STI-34-85094 C
STI-34-85095 D
STI-34-85096 E
STI-34-85097 F

580 x 280 x 200 mm



STI-34-85068 A
STI-34-85069 B
STI-34-85070 C
STI-34-85071 D
STI-34-85072 E
STI-34-85073 F

STI-34-85098 A
STI-34-85099 B
STI-34-85100 C
STI-34-85101 D
STI-34-85102 E
STI-34-85103 F

580 x 280 x 260 mm



STI-34-85074 A
STI-34-85075 B
STI-34-85076 C
STI-34-85077 D
STI-34-85078 E
STI-34-85079 F

STI-34-85104 A
STI-34-85105 B
STI-34-85106 C
STI-34-85107 D
STI-34-85108 E
STI-34-85109 F

Boden ungelocht
 Bottom non-perforated
 Fond non perforé
 Fondo no perforada
 Fondo non forato



STI-34-85110 580 x 280 x 100 mm
STI-34-85111 580 x 280 x 135 mm
STI-34-85112 580 x 280 x 150 mm
STI-34-85113 580 x 280 x 200 mm
STI-34-85114 580 x 280 x 260 mm

Boden gelocht
 Bottom perforated
 Fond perforé
 Fondo perforada
 Fondo forato



STI-34-85115 580 x 280 x 100 mm
STI-34-85116 580 x 280 x 135 mm
STI-34-85117 580 x 280 x 150 mm
STI-34-85118 580 x 280 x 200 mm
STI-34-85119 580 x 280 x 260 mm

Deckel gelocht
 Lid perforated
 Courvercle perforé
 Tapa perforada
 Coperchio forato



580 x 280 mm

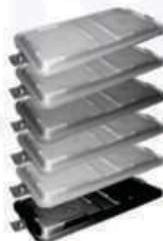

STI-34-85120 A
STI-34-85121 B
STI-34-85122 C
STI-34-85123 D
STI-34-85124 E
STI-34-85125 F

Sicherheitsdeckel
 Safety Lid
 Courvercle de sécurité
 Tapa de seguridad
 Coperchio di Protezione



580 x 280 mm



STI-34-85126 A
STI-34-85127 B
STI-34-85128 C
STI-34-85129 D
STI-34-85130 E
STI-34-85131 F

Siebkörbe Edelstahl
Wire baskets, special steel
Paniers grillagés en acier de haute qualité
Cestillos de acero fino
Cestelli in acciaio fino



STI-34-85132 540 x 255 x 30 mm
STI-34-85133 540 x 255 x 50 mm
STI-34-85134 540 x 255 x 70 mm
STI-34-85135 540 x 255 x 100 mm

Siebkörbe Edelstahl
Wire baskets, special steel
Paniers grillagés en acier de haute qualité
Cestillos de acero fino
Cestelli in acciaio fino



STI-34-85136 485 x 255 x 30 mm
STI-34-85137 485 x 255 x 50 mm
STI-34-85138 485 x 255 x 70 mm
STI-34-85139 485 x 255 x 100 mm

Siebboden
Separate floors
Fond du crible
Cestas-cuerpos
Fondo di Cestello



STI-34-85140 545 x 255 x 30 mm

Spannrahmen für Einschlagtücher
Tension Clips for Towels
Cadre tendeur à champs
Marcos tensores para paños
Telaio di fissaggio



STI-34-85141 545 x 255 mm

Einschlagtücher aus Baumwolle
Wrapping drapes, cotton
Champs, coton
Paños de embalaje de algodón
Telo, cotone

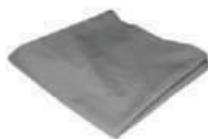

STI-34-85142 130 x 60 cm
STI-34-85143 140 x 100 cm
STI-34-85144 185 x 45 cm
STI-34-85145 185 x 60 cm

Deckel gelocht - Boden ungelocht
Lid perforated - Bottom non perforated
Courvercle perforé - Fond non perforé
Tapa perforada - Fondo no perforada
Coperchio forato - Fondo non forato

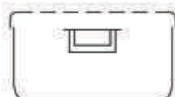

Deckel gelocht - Boden gelocht
Lid perforated - Bottom perforated
Courvercle perforé - Fond perforé
Tapa perforada - Fondo perforada
Coperchio forato - Fondo forato

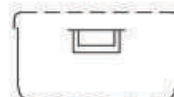

465 x 280 x 100 mm



STI-34-85146 A
STI-34-85147 B
STI-34-85148 C
STI-34-85149 D
STI-34-85150 E
STI-34-85151 F

STI-34-85164 A
STI-34-85165 B
STI-34-85166 C
STI-34-85167 D
STI-34-85168 E
STI-34-85169 F

465 x 280 x 135 mm



STI-34-85152 A
STI-34-85153 B
STI-34-85154 C
STI-34-85155 D
STI-34-85156 E
STI-34-85157 F

STI-34-85170 A
STI-34-85171 B
STI-34-85172 C
STI-34-85173 D
STI-34-85174 E
STI-34-85175 F

465 x 280 x 150 mm



STI-34-85158 A
STI-34-85159 B
STI-34-85160 C
STI-34-85161 D
STI-34-85162 E
STI-34-85163 F

STI-34-85176 A
STI-34-85177 B
STI-34-85178 C
STI-34-85179 D
STI-34-85180 E
STI-34-85190 F

Sicherheitsdeckel - Boden ungelocht
 Safety Lid - Bottom non-perforated
 Courvercle de securité - Fond non perforé
 Tapa de seguridad - Fondo no perforada
 Coperchio di Protezione - Fondo non forato

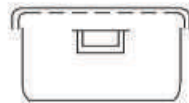

Sicherheitsdeckel - Boden gelocht
 Safety Lid - Bottom perforated
 Courvercle de securité - Fond perforé
 Tapa de seguridad - Fondo perforada
 Coperchio di Protezione - Fondo forato

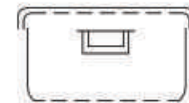

465 x 280 x 100 mm



STI-34-85191 A
STI-34-85192 B
STI-34-85193 C
STI-34-85194 D
STI-34-85195 E
STI-34-85196 F

STI-34-85209 A
STI-34-85210 B
STI-34-85211 C
STI-34-85212 D
STI-34-85213 E
STI-34-85214 F

465 x 280 x 135 mm



STI-34-85197 A
STI-34-85198 B
STI-34-85199 C
STI-34-85200 D
STI-34-85201 E
STI-34-85202 F

STI-34-85215 A
STI-34-85216 B
STI-34-85217 C
STI-34-85218 D
STI-34-85219 E
STI-34-85220 F

465 x 280 x 150 mm



STI-34-85203 A
STI-34-85204 B
STI-34-85205 C
STI-34-85206 D
STI-34-85207 E
STI-34-85208 F

STI-34-85221 A
STI-34-85222 B
STI-34-85223 C
STI-34-85224 D
STI-34-85225 E
STI-34-85226 F

Boden ungelocht
 Bottom non-perforated
 Fond non perforé
 Fondo no perforada
 Fondo non forato

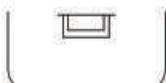

STI-34-85227 465 x 280 x 100 mm
STI-34-85228 465 x 280 x 135 mm
STI-34-85229 465 x 280 x 150 mm

Boden gelocht
 Bottom perforated
 Fond perforé
 Fondo perforada
 Fondo forato

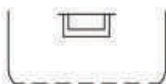

STI-34-85230 465 x 280 x 100 mm
STI-34-85231 465 x 280 x 135 mm
STI-34-85232 465 x 280 x 150 mm

Deckel gelocht
 Lid perforated
 Courvercle perforé
 Tapa perforada
 Coperchio forato

465 x 280 mm



STI-34-85233 A
STI-34-85234 B
STI-34-85235 C
STI-34-85236 D
STI-34-85237 E
STI-34-85238 F

Sicherheitsdeckel
 Safety Lid
 Courvercle de sécurité
 Tapa de seguridad
 Coperchio di Protezione

465 x 280 mm

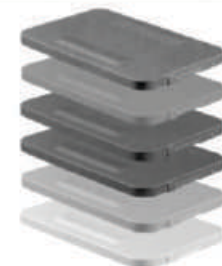

STI-34-85239 A
STI-34-85240 B
STI-34-85241 C
STI-34-85242 D
STI-34-85243 E
STI-34-85244 F

Siebkörbe Edelstahl
Wire baskets, special steel
Paniers grillagés en acier de haute qualité
Cestillos de acero fino
Cestelli in acciaio fino



STI-34-85245 405 x 255 x 30 mm
STI-34-85246 405 x 255 x 50 mm
STI-34-85247 405 x 255 x 70 mm
STI-34-85248 405 x 255 x 100 mm

Siebboden
Separate floors
Fond du crible
Cestas-cuerpos
Fondo di Cestello



STI-34-85249 405 x 255 x 30 mm

Spannrahmen für Einschlagtücher
Tension Clips for Towels
Cadre tendeur à champs
Marcos tensores para paños
Telaio di fissaggio



STI-34-85250 405 x 255 mm

Einschlagtücher aus Baumwolle
Wrapping drapes, cotton
Champs, coton
Paños de embalaje de algodón
Telo, cotone

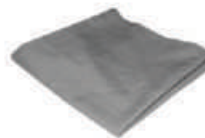

STI-34-85251 140 x 100 cm

High Frequency Surgery



Elektroden zum Schneiden und Koagulieren
 Cutting and Coagulation Electrodes
 Electrodes pour la coupe et la coagulation
 Electrodo para cortar y para la coagulación
 Elettrodi di taglio e di coagulazione

Serie MICRO + DENTAL



STI-35-85252
 Fig. 1



STI-35-85253
 Fig. 2
 45°



STI-35-85254
 Fig. 3
 120°



STI-35-85255
 Fig. 11
 Ø 3 mm



STI-35-85256
 Fig. 12
 Ø 5 mm



STI-35-85257
 Fig. 13
 Ø 8 mm



STI-35-85258
 Fig. 14



STI-35-85259
 Fig. 15
 7,0x1,5 mm
 45°



STI-35-85260
 Fig. 16
 7 mm
 45°



STI-35-85261
 Fig. 17
 6,0x1,3 mm



STI-35-85262
 Fig. 18
 7,0x1,7 mm
 30°



STI-35-85263
 Fig. 21
 7,0x1,7 mm



STI-35-85264
 Fig. 31
 Ø 0,6 mm
 45°



STI-35-85265
 Fig. 33
 Ø 1,7 mm
 45°



STI-35-85266
 Fig. 34
 Ø 3,0 mm
 45°



STI-35-85267
 Fig. 35



STI-35-85268
 Fig. 36
 90°

Schaft - shaft - tige
 vástago - asta
 Ø 1,6 mm

Elektroden zum Schneiden und Koagulieren
Cutting and Coagulation Electrodes
Electrodes pour la coupe et la coagulation
Electrodos para cortar y para la coagulación
Elettrodi di taglio e di coagulazione

Serie MICRO + DENTAL



STI-35-85269
Fig. 51
Ø 3 mm
45°



STI-35-85270
Fig. 52
7,0x1,7 mm
45°



STI-35-85271
Fig. 53
45°



STI-35-85272
Fig. 54



STI-35-85273
Fig. 55



STI-35-85274
Fig. 56
Ø 5 mm
45°



STI-35-85275
Fig. 61
45°



STI-35-85276
Fig. 62
90°

Schaft · shaft · tige
vástago · asta
Ø 4 mm

Serie STANDARD



STI-35-85277



STI-35-85278



STI-35-85279



STI-35-85280



Ø mm	STI-35-85281
5	STI-35-85281
10	STI-35-85282
20	STI-35-85283



Ø mm	STI-35-85284
10	STI-35-85284
15	STI-35-85285
20	STI-35-85286



Ø mm	STI-35-85287
2	STI-35-85287
4	STI-35-85288
6	STI-35-85289

Schaft · shaft · tige
vástago · asta
Ø 4 mm

Handchirurgie, Ophthalmologie, Plastische Chirurgie, Experimentelle Chirurgie
 Hand Surgery, Ophthalmology, Plastic Surgery, Experimental Surgery
 Chirurgie de la main, Ophtalmologie, Chirurgie plastique, Chirurgie expérimentale
 Cirugía de la mano, Oftalmología, Cirugía plástica, Cirugía experimental
 Chirurgia della mano, Oftalmologia, Chirurgia plastica, Chirurgia sperimentale



STI-35-85290
 11 cm



STI-35-85291
 11 cm



STI-35-85292
 11 cm



STI-35-85293
 11 cm
 45°



STI-35-85294
 11 cm
 45°



STI-35-85295
 11 cm
 45°

Mikrochirurgie, HNO · Microsurgery, ENT · Microchirurgia, ORL · Microcirurgia, ORL · Microchirurgia, ORL



STI-35-85296
 16,5 cm



STI-35-85297
 16,5 cm



STI-35-85298
 16,5 cm
 1 mm



STI-35-85299
 16,5 cm



STI-35-85300
 16,5 cm
 1 mm

Mikrochirurgie, HNO · Microsurgery, ENT · Microchirurgie, ORL · Microcirugia, ORL · Microchirurgia, ORL



STI-35-85301
16,5 cm



STI-35-85302
16,5 cm



STI-35-85303
16,5 cm



STI-35-85304
16,5 cm



STI-35-85305
16,5 cm
1 mm

Gynäkologie, HNO, Tonsillen Chirurgie · Gynaecology, ENT, Tonsil Surgery · Gynécologie, ORL, Chirurgie des amygdales
Ginecologia, ORL, Cirugía de amígdalas · Ginecologia, ORL, Chirurgia tonsillare



STI-35-85306
19,5 cm



STI-35-85307
19,5 cm
1 mm



STI-35-85308
19,5 cm
1 mm



STI-35-85309
19,5 cm
2 mm

Bipolare Koagulation
Bipolar Coagulation
Coagulation bipolaire
Coagulación bipolar
Coagulazione bipolare

Neurochirurgie · Neurosurgery · Neurochirurgie · Neurocirugía · Neurochirurgia



STI-35-85310
19,5 cm

STI-35-85311
19,5 cm
1 mm

STI-35-85312
19,5 cm
2 mm

STI-35-85313
19,5 cm
1 mm

STI-35-85314
19,5 cm
1 mm

STI-35-85317
0,3 mm

STI-35-85318
0,7 mm

STI-35-85319
1,2 mm

STI-35-85315 STI-35-85316
22,5 cm
0,3-1,2 mm

Anschlußkabel
Connection Cords
Cordons d'alimentation
Cables de conexión
Cavi da connessione

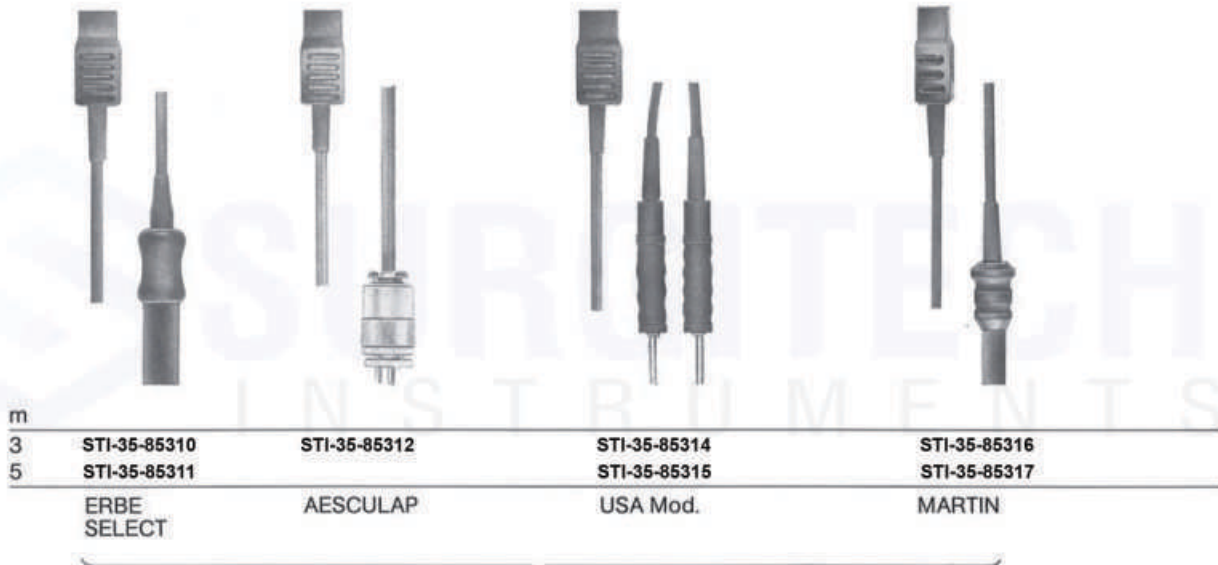

HF-Chirurgie-Geräte
Electrosurgery Equipment
Electrobistouris
Electrobisturías
Elettrobisturi



CONTACT US

MANUFACTURERS & EXPORTERS OF SURGICAL, DENTAL, OPHTHALMIC,
ENT, VETERINARY, BEAUTY & ALL INSTRUMENTS.

Address: Office#21, building 503/2,
Khadim Ali Road, Near Pizza Track, Sialkot

Cell : +92 346 5465608

Phone : +92 51 5774891

Email: info@surgitech.pk

Web: www.surgitech.pk